

ST/FST FLEX SECURE

Sliding door with intruder protection



Security and convenience intelligently combined

A high level of security is essential for public buildings. However, also many shop owners are aware of the importance of preventive vandalism and burglary protection.

This is where dormakaba's automatic sliding doors ST FLEX and FST FLEX SECURE comes into play, as this system unites the convenience of an automatic door with effective burglary and vandalism protection. Furthermore, the elegant, automatic sliding door solution provides facility operators with a high level of security.

SECURE stands for maximum protection

Despite its elegant design, dormakaba's ST FLEX and FST FLEX SECURE sliding door system provides maximum and at the same time invisible intruder and vandalism protection according to VDS (Association of German Property Insurers) resistance class WK2/RC2.

Your benefit: Compared to similar security systems, there are no visible barriers so that your display windows remain as transparent and inviting as ever without any negative effect on their advertising space characteristics.

Technical details of ST FLEX SECURE at a glance

- A continuous floor guide rail at the bottom of the door and an operator-integrated anti-tamper protection avoid that the door is levered out
- Four-point hook locking device with automatic locking action at the main closing edge and lateral door profiles
- Special burglary-protection glazing is adhered to the door profile with the aid of a special adhesive

Furthermore, the door may be equipped with any product from the comprehensive range of accessories for our standard sliding door systems.

If requested, ST FLEX and FST FLEX SECURE may be fitted with DIN 18650 and EN 16005 compliant safety equipment – depending on the prevailing structural conditions and risk assessment.

Features and benefits

- Prefabricated door panels
- Flexible system: may be combined with ES 200 and ES 200-2D
- The automatic sliding door is tested from European Standard ENV 1627 to 1630
- Glazing tested to DIN EN 356, resistance class P4A:
 - Security double-glazing (22 mm LSG)
 - Mono safety glazing (10 mm LSG)

Security-relevant components

- 1 dormakaba operator-integrated protection against levering-out over the full passage width
 - 2 dormakaba SECURE 4-point locking device
 - 3 dormakaba SECURE floor guide over the full door width
 - 4 Continuous interlocking profiles at the secondary closing edge
 - 5 Burglary-resistant laminated safety glass (resistance class WK2) P4A (10 mm) or laminated safety glass P4A (22 mm) adhered to the frame with special adhesive
 - 6 Special anchoring to meet the requirements of resistance class WK2/RC2 (1. anchoring 270 mm from upper edge of operator – then every 400 mm)
- ☐ See page 9 for corresponding cross sections.

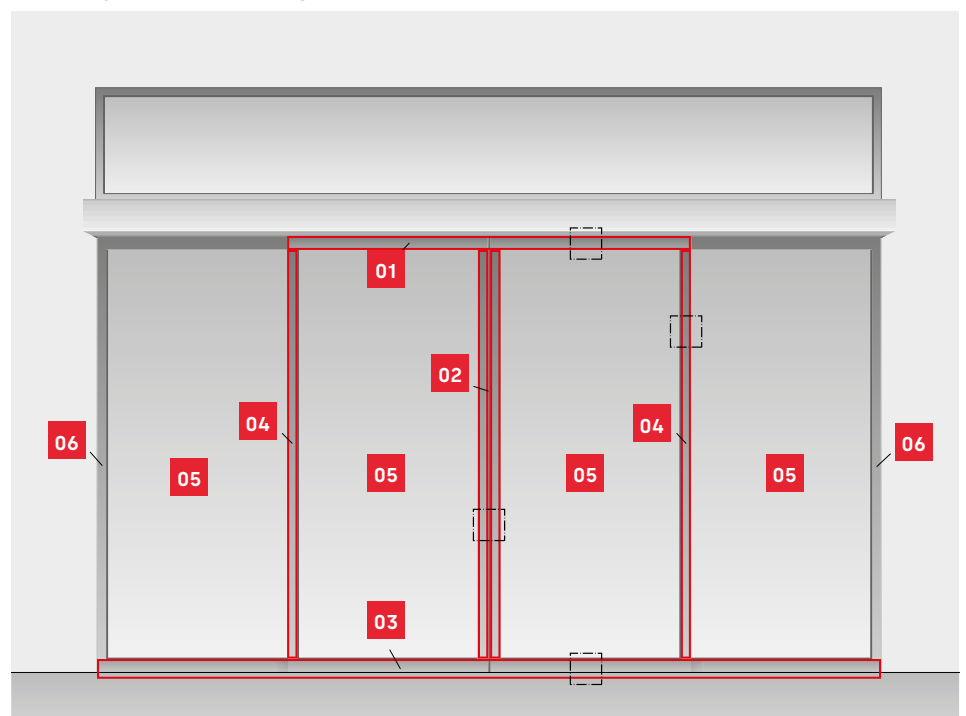

Evidence of performance

Burglar resistance

Expert statement

10-001167-PR02 dated 18. October 2011
(GAS01-C01-05-en-01)



Translation of Expert Statement 10-001167-PR02 dated 6 October 2011

Client	DORMA GmbH + Co. KG DORMA Platz 1 58256 Ennepetal Germany
Product	Burglar resistant sliding door system, WK2 (RC2)
Designation	ST FLEX SECURE / FST FLEX SECURE
Clear opening dimensions (W x H)	different (see type list)
(Frame) Material	Aluminium, DORMA profile system ST FLEX DORMA operator profiles ES200
Attack side	External face Two leaf / single leaf sliding, with / without glazed side panels,
Type of opening	with / without glazed top light 1 - / 2 - / 3-part
Glazing	DIN EN 356 Klasse P4A Multipoint lock Fuhr Type 3 pivoted bold lock with 4 pivoted bolts as per DIN 18251 Class 4; Profile cylinder as per DIN 18252 P2BZ; continuous strike plate; continuous coupling rim ST FLEX; continuous dis- engagement protection in drive; continuous DORMA floor guide track
Hardware	
Installation	As per installation instructions from company DORMA GmbH + Co. KG

Basis

DIN EN 1627 : 2011
Windows, doors, shutters - Burglar resistance - Requirements and classification
DIN EN 1628 : 2011
DIN EN 1629 : 2011
DIN EN 1630 : 2011

Test report 10-001154-PB01-
C01-05-de-01 dated
20 December 2010

Result protocol 10-001209-PR01
(EP01-C01-05-de-01) dated
06 July 2011

Result protocol 10-001209-PR02
(EP01-C01-05-de-01) dated
06 July 2011

Design sheets
Annex 1, pp 1 to 13
Annex 2, pp 1 to 36

Validity

Testing for burglar resistance does not allow any statement to be made on any further characteristics regarding performance and quality of the construction submitted.

Validity of the expert statement expires with expiry of any one of the above items referred to as basis (standards or test reports).

Notes on publication

The ift Guidance Sheet "Conditions and Guidance for the Use of ift Test Reports" applies.

The cover sheet including the type list can be used as an abstract.

Contents

The expert statement comprises a total of 56 pages

Cover sheet
Type list
Expert Statement
1 Order
2 Basis of evaluation
3 Evaluation
4 Results and statement

Annex 1 (1 page)
Annex 2 (36 pages)

Burglar resistance



Resistance Class RC 2*

*) on the basis of the mentioned test reports and the complementary, change-related specifications

ift Rosenheim
18. October 2011

Robert Krippahl, Dipl.-Ing. (FH)
Deputy Head of Testing Department
Building Components

Jens Pickelmann
Operating Testing Officer
Mechanics



ift Rosenheim GmbH
Geschäftsführer:
Dipl.-Ing. (FH) Ulrich Sieberath
Dr. Jochen Peichl

Theodor-Giell-Str. 7 - 9
D-83026 Rosenheim
Tel.: +49 (0)8031/261-0
Fax: +49 (0)8031/261-290
www.ift-rosenheim.de

Sitz: 83026 Rosenheim
AG Traunstein, HRB 14763
Sparkasse Rosenheim
Kto. 3822
BLZ 711 500 00

Notified Body Nr.: 0757
Anerkannte PUZ-Stelle: BAY 18

DAP-PL-0808 59
DAP-ZE-2288 00
TGA-ZM-16-93-90
TGA-ZM-16-93-80

Type list

No.	Tested type	Design variants approved by expert statement	Evidence / reports requirements
1.	Single-panel and double-panel sliding door systems with glazed side screens and fanlight	Single-panel and double-panel sliding door systems available: with and without side screens with and without fanlight (glazed in one-piece / two-part / 3-part version)	Test report 10-001154-PB01-C01-05-de-01 dated 20 December 2010 Result protocol 10-001209-PR01 (EP01-C01-05-de-01) and 10-001209-PR02 (EP01-C01-05-de-01) dated 06 July 2011 Expert statement 10-001167-PR02 dated 18 October 2011
2.	Single-panel and double-panel sliding door systems with P4A double-glazing, a thickness of 20 mm or single-glazing	Use of P4A double-glazing with a thickness of 22 mm P4A single-glazing with a thickness of 10 mm	Test report 10-001154-PB01-C01-05-de-01 dated 20 December 2010 Result protocol 10-001209-PR01 (EP01-C01-05-de-01) and 10-001209-PR02 (EP01-C01-05-de-01) dated 06 July 2011 Expert statement 10-001167-PR02 dated 18 October 2011
3.	Single-panel and double-panel sliding door systems with a clear passage width of 2500 mm x 3000 mm or 700 mm x 2800 mm	Single-panel and double-panel sliding door systems with various clear opening dimensions: Double-panel version: Width 800 mm – 3000 mm Height 2100 mm – 3100 mm Single-panel version: Width 700 mm – 3000 mm Height 2100 mm – 3100 mm FST-Türen (double-panel and single-panel version): Width 900 mm – 3000 mm Height 2100 mm – 3100 mm	Test report 10-001154-PB01-C01-05-de-01 dated 20 December 2010 Result protocol 10-001209-PR01 (EP01-C01-05-de-01) and 10-001209-PR02 (EP01-C01-05-de-01) dated 06 July 2011 Expert statement 10-001167-PR02 dated 18 October 2011
4.	Single-panel and double-panel sliding door systems with glazed side screens for mounting at solid surrounding walls	Single-panel and double-panel sliding door systems with and without side screens for mounting in mullion and transom construction tested as a burglar-resistant component to resistance class WK2 or higher with location of profiles / screws in the mullion res. transom area	Test report 10-001154-PB01-C01-05-de-01 dated 20 December 2010 Result protocol 10-001209-PR01 (EP01-C01-05-de-01) and 10-001209-PR02 (EP01-C01-05-de-01) dated 06 July 2011

Please note: The stipulated dimensions are only applicable for burglar resistance tests.

Expert statement
10-001167-PR02-(GAS01-CO1-05-de-01) dated 18. October 2011
Client: DORMA GmbH + Co. KG, 58256 Ennepetal, Germany

Preparation of adjacent walls by others		ST FLEX SECURE	FST FLEX SECURE*
The adjacent walls must have the following properties to meet the requirements of resistance class WK2/RC2:			
Masonry to DIN 1053-1	<ul style="list-style-type: none"> - Nominal thickness - Crushing resistance of brickwork - Mortar group 	<ul style="list-style-type: none"> ≥ 115 mm ≥ 12 II 	
Steel concrete to DIN 1045	<ul style="list-style-type: none"> - Nominal thickness - Strength class 	<ul style="list-style-type: none"> ≥ 100 mm B15 	

Door parameters		ST FLEX SECURE	FST FLEX SECURE
Double-panel sliding door	<ul style="list-style-type: none"> - Clear passage width (LW) - Clear passage height (LH) - Door panel weight 	<ul style="list-style-type: none"> 1.000 – 3.000 mm 2.100 – 3.100 mm max. 2 x 160 kg 	<ul style="list-style-type: none"> 1.000 – 3.000 mm 2.100 – 3.100 mm max. 2 x 130 kg
Single-panel sliding door	<ul style="list-style-type: none"> - Clear passage width (LW) - Clear passage height (LH) - Door panel weight 	<ul style="list-style-type: none"> 700 – 3.000 mm 2.100 – 3.100 mm max. 1 x 200 kg 	<ul style="list-style-type: none"> 900 – 1.800 mm 2.100 – 3.100 mm max. 1 x 150 kg

Please note:

The available system dimensions (especially the clear passage height LH and the clear passage width LW) depend on the type of glazing, the door-panel weight, the size of the panels (height in relation to width) and effects like for example draughts within the building. Our friendly dormakaba sales staff will be pleased to give advice and will gladly help you find the suitable door solution for your requirements.

The approved escape route function is not available in the operating states "Off" or "Locked".

Versions		ST FLEX SECURE	FST FLEX SECURE
Profile systems	Universal profile system with security glazing to DIN EN 356 category P4A	●	●
	Universal profile system with security double-glazing	○	○
	With side screens	○	○
	Combined sensors to DIN 18650 and EN 16005	●	●
	Continuous floor-integrated guide rail The floor guide rail is always required and has to be provided by others!	●	●
Elevation height and depth of operator 150 mm x 180 mm		●	●
Fanlight in one-piece / two-part / 3-part version		○	○
ST FLEX safety screen		○	○

Basic module (BM)		ST FLEX SECURE	FST FLEX SECURE
Modular design		●	●
Microprocessor-controlled function programs	<ul style="list-style-type: none"> - Off - Automatic - Permanent Open - Partial Open - Exit Only - Night-/Bank Function 	●	●
Automatic reversing		●	●
Ready for connection of	dormakaba SECURE locking device	●	●
	Light curtains	●	●
Adjustment of all basic parameters via integrated display and keys		●	●
24 V output for external accessories		●	●
Read-out error log with error codes		●	●
DCW® bus connection (Protocol DORMA Connect and Work)		●	●
Emergency power supply via rechargeable battery pack		○	-

● standard ○ optional – No

Additional equipment	ST FLEX SECURE	FST FLEX SECURE
Manual lock release for dormakaba SECURE locking devices with 42/32 profile cylinder by others.	●	●
Light barriers	○	○
Rechargeable battery pack (emergency opening/closing)	○	●
Coupling module for connection to EIB or LON building management systems	○	○
Function module (FM) – 3 door status contacts edges – Safeguarding of main closing edge & secondary closing – Panic closing (Observe corresponding regulations!) – Bell contact – Airlock control – Synchronous operation	○	○
DIN 18650 and EN 16005 function module The DIN 18650 and EN 16005 function module provides tested monitoring of the secondary closing edges for compliance with the German Industrial Standard DIN 18650 and EN 16005	○	○

Technical operator data	ST FLEX SECURE	FST FLEX SECURE
dormakaba SECURE locking device	●	●
Suitable for application in emergency exits and escape routes	–	
Height	150 mm	150 mm
Overall depth	180 mm	180 mm
Max. opening and closing force 150 N	●	●
Opening speed (incremental setting)	10 – 70 cm/s	10 – 70 cm/s
Closing speed (incremental setting)	10 – 50 cm/s	10 – 50 cm/s
Hold-open time	0 – 180 s	0 – 180 s
Supply voltage, frequency	230 V, 50/60 Hz	230 V, 50/60 Hz
Power consumption	250 W	250 W
Class of protection	IP 20	IP 20
Admissible temperature	- 20 – + 60 °C	- 20 – + 60 °C
Admissible humidity (relative)	max. 93 % (non condensing)	max. 93 % (non condensing)
Tested according to Low Voltage Directive and EMC guidelines	●	●
Manufactured to ISO 9001	●	●

Horizontal sections

Door is closed

Corridor-mounted double-panel systems with side screens

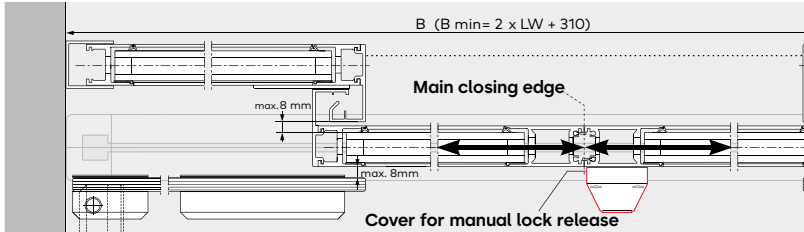

Door is open

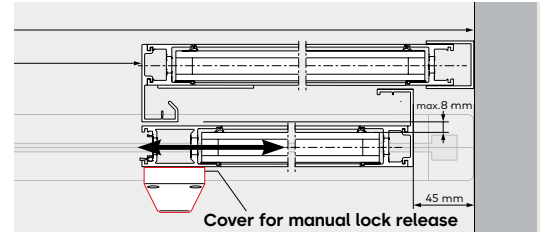

Corridor-mounted double-panel systems with side screens – security screens on the inside

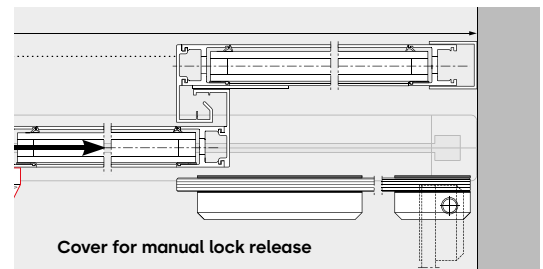
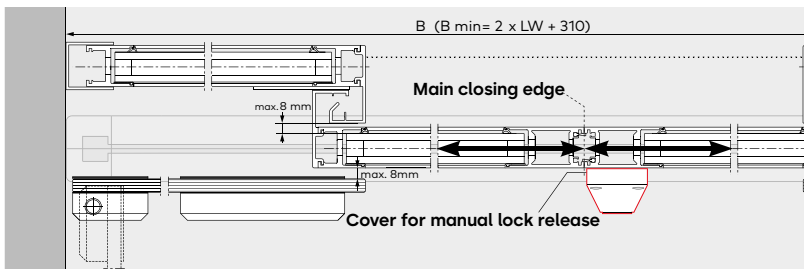

Lintel-mounted double-panel systems with side screens

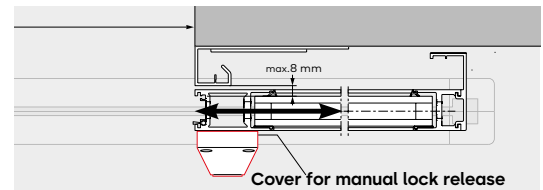
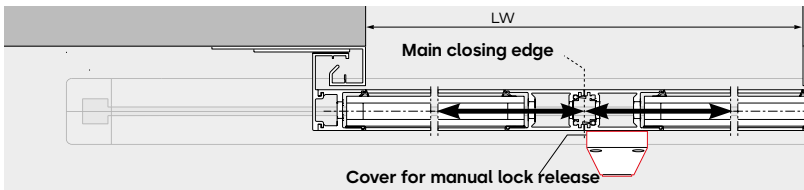

Corridor-mounted single-panel systems with side screens (wall connection, opening to the left/right)

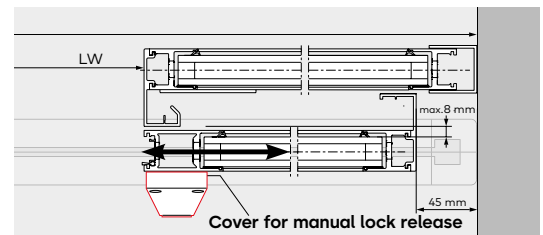
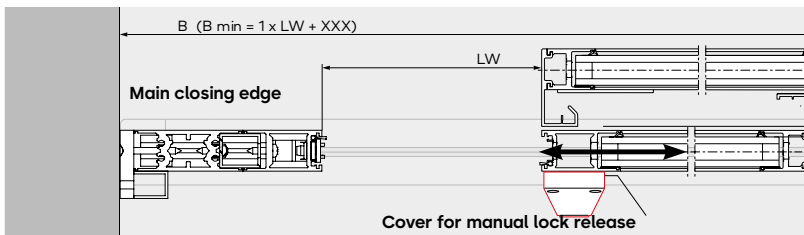

Corridor-mounted single-panel systems with side screens – security screens on the inside (wall connection, opening to the left/right)

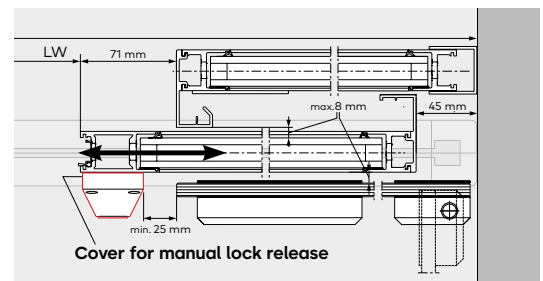
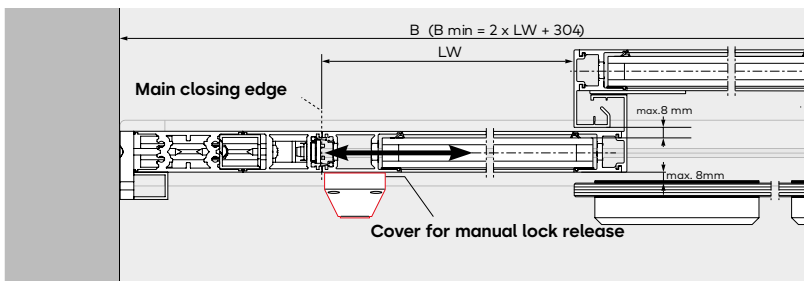

Lintel-mounted single-panel systems with side screens (wall connection, opening to the left/right)

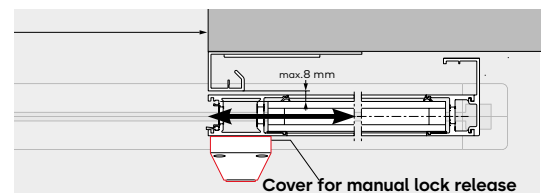
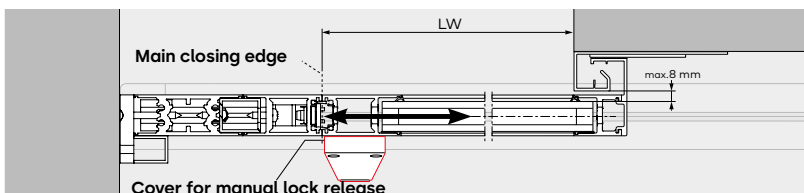

LW = Clear passage width B = System width

Vertical sections

Corridor-mounted systems with floor-integrated guide rail

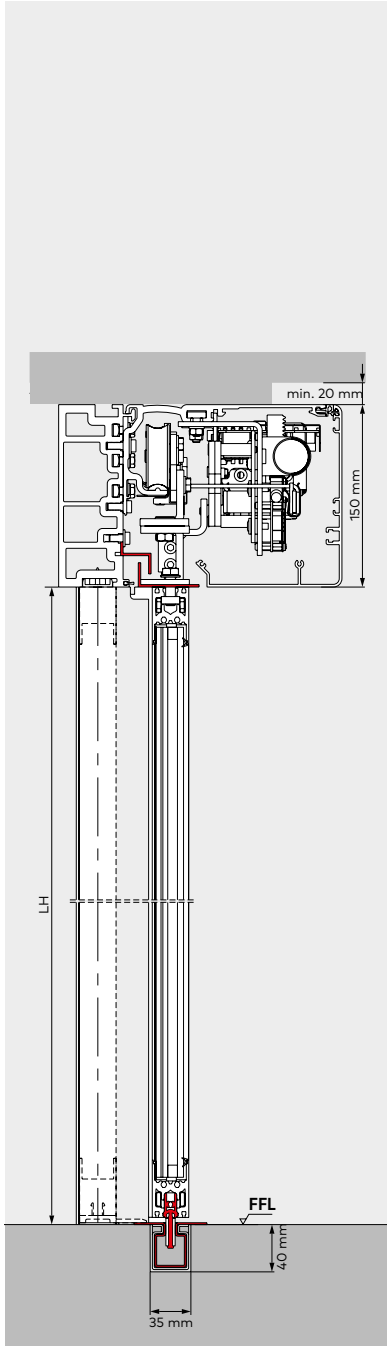

Corridor-mounted systems with floor-integrated guide rail and fanlight

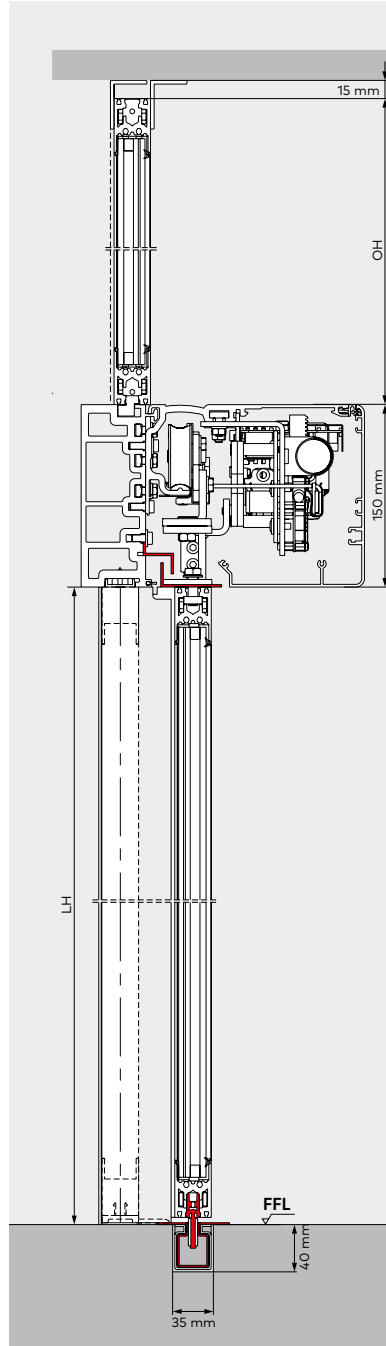

Lintel-mounted systems for connection to façade (by others) with floor-integrated guide rail

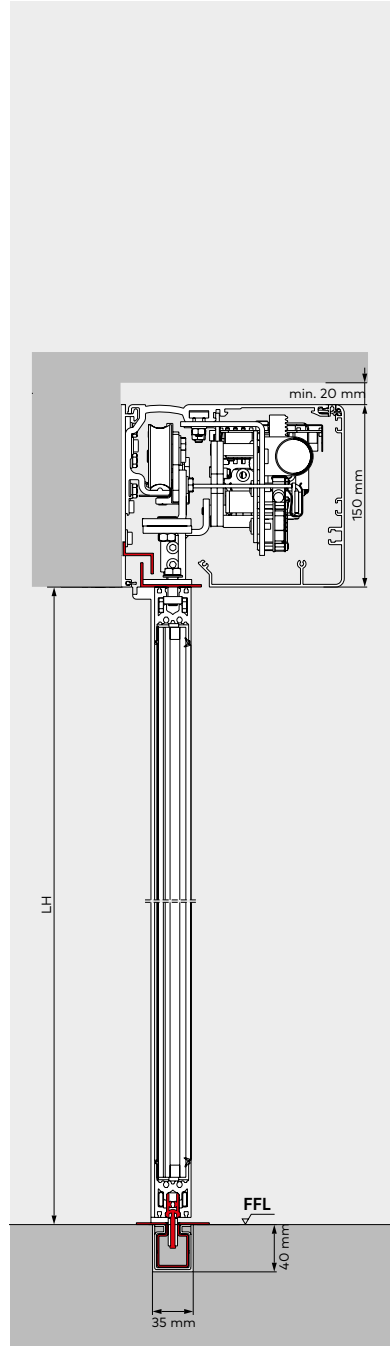

Please note:

Please visit our website www.dormakaba.com, where you can download detailed descriptions of our current product range.

OH	Fanlight height
LH	Clear passage height
B	Clear passage width
LW	Clear passage width
FFL	Finished floor level

Detailed cross sections

Ceiling connection of fanlight

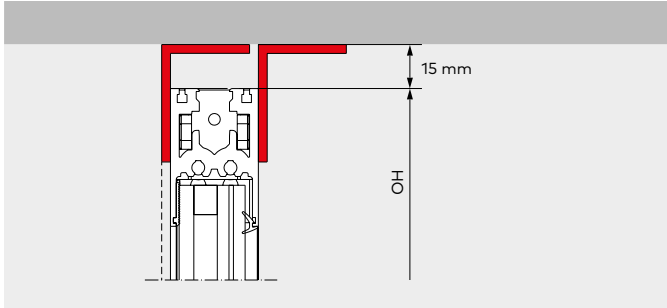

Unlocking of sliding panel

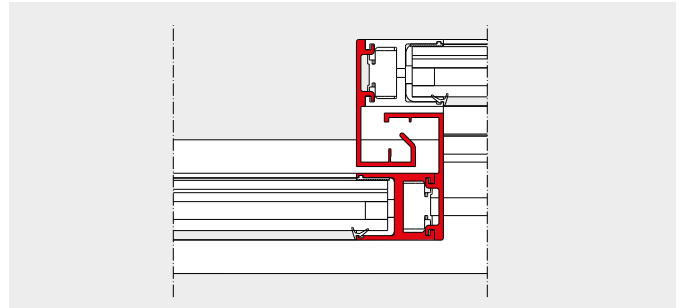

Connection of fanlight to operator

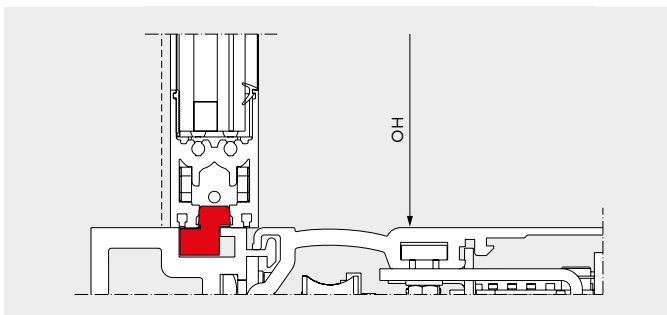

Wall connection

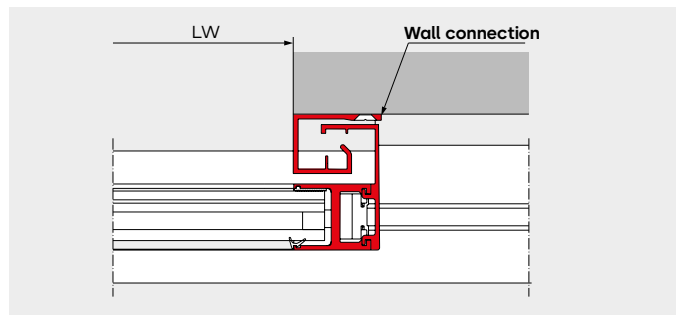

Security feature inside operator

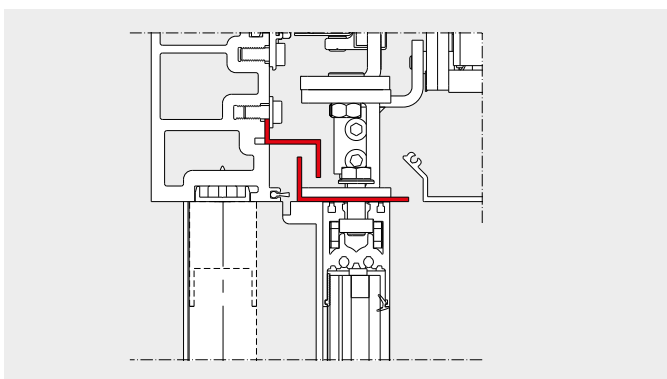

Main closing edge – door is closed

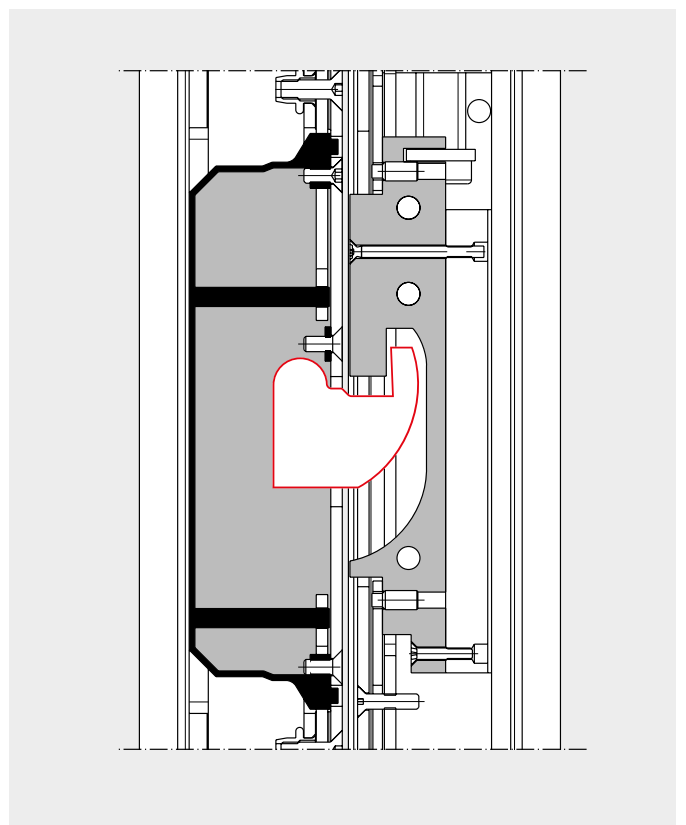

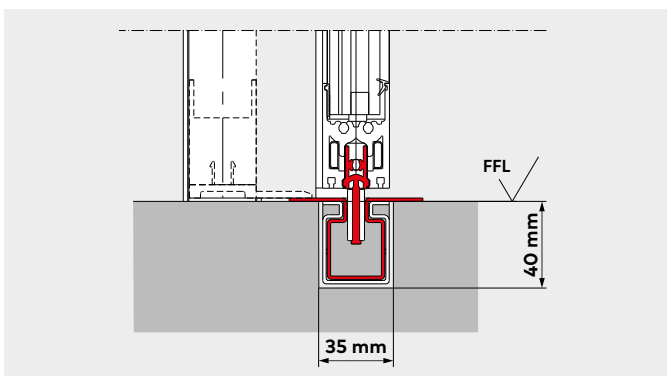

Floor guide

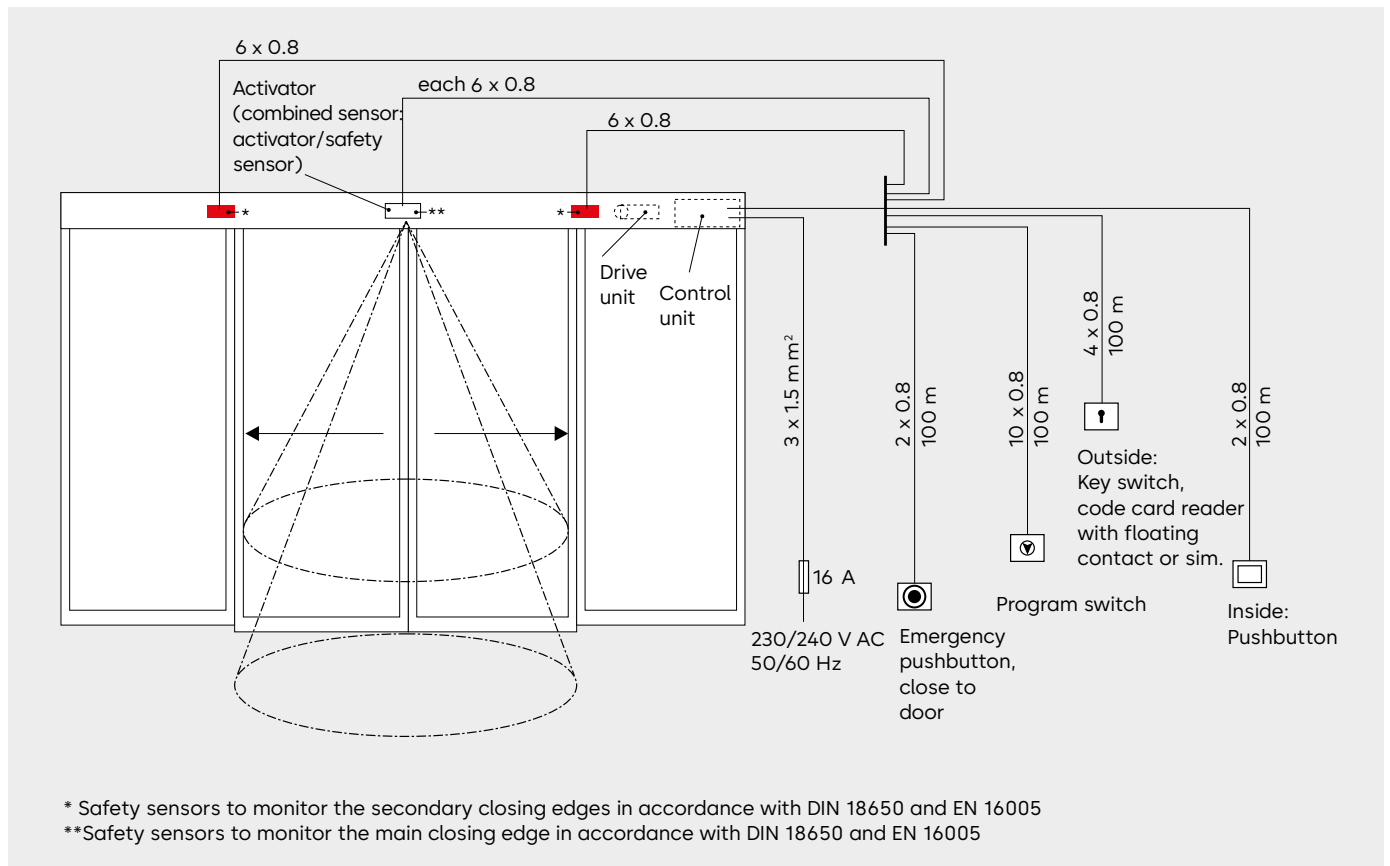

Connections



Switches

	Designation	Specification	Installation system	Order No.
	On/Off switch	White, aluminium, flush-mounting, 80 x 80 mm	Gira S-Color	19135403150
	CleanSwitch	contactless radar push-button, System 55, flush-mounted, detection zone adjustable 10 - 50 cm, dimensions: 80 x 80 x 40 mm, switch insert 55 x 55 mm, colour: white	neutral wheelchair door open	16737401170 16737501170 16737601170



Program switches



A program switch from dormakaba's broad range of accessories allows the automatic door system to meet individual requirements and provides easy handling.

The corresponding 3-position program switches are available in various designs and suitable for all kinds of applications.



They offer various options, from a mechanical to a full-electronic version, alternatively also lockable via profile half-cylinder or in a full-electronic way via code.

- Up to 5 different functions:
Off, Automatic, Exit Only, Partial Open, Permanent Open
- Electronic program switches in System 55 design to meet the highest aesthetical demands



For sliding door operators	Designation	Specification	Installation system	Order No.
	PG-S1	5-position, aluminium, white, flush-mounted version, 80 x 80 x 40 mm	Gira S-Color	19135401150
	PG-S2	5-position, lockable, aluminium, white, flush-mounted version, 80 x 80 x 40 mm	Gira S-Color	19135602150
	EPS-S	Full-electronic program switch in System 55 design, 5-position, lockable via code or additional TL-ST S55 key switch, membrane keypad aluminium-coloured, white, flush-mounted version, 80 x 80 mm	System 55	16556901150

For sliding door operators in emergency exits and escape routes (FST)	Designation	Specification	Installation system	Order No.
	PG-FST1	5-position, lockable, aluminium, white, flush-mounted version, 80 x 80 mm	Gira S-Color	19135603150
	EPS-FST	Full-electronic program switch in System 55 design, 5-position, lockable via code or additional TL-ST S55 key switch, membrane keypad, aluminium-coloured, white, flush-mounted version, 80 x 80 mm	System 55	16556801150

Pushbuttons

Palm pushbutton	Designation	Specification	Installation system	Order No.
		Single-pole changeover contact, single-type frame, white, flush-mounted version	System 55	19144701170
Key switches	Designation	Specification		Order No.
	KT 3-1	1 NO contact with profile half-cylinder, may be replaced for any profile half-cylinder of a master key system, key only retractable in neutral position, aluminium, metal, 75 x 75 x 60 mm		
	KT 3-1 UP	flush-mounted version		05054531332
	KT 3-1 AP	surface-mounted version		05054631332
	KT 8	Lettering "Auf, Zu" (German for "Open/Closed"), 2 NO contacts, with profile half-cylinder, may be replaced for any profile half-cylinder of a master key system, key only retractable in neutral position, aluminium, metal, 75 x 75 x 60 mm		
	KT 8 UP	flush-mounted version		05054831332
	KT 8 AP	surface-mounted version		05054931332

Emergency pushbuttons

	Designation	Specification	Installation system	Order No.
	NAT	Designed to interrupt the automatic movement of the door, emergency pushbutton (function: Emergency Off) for automatic door operators, manufactured to ZH 1/494 or BGR 232, DIN 18650 and EN 16005, red knob with yellow centre insert, max. load current: 10 A at 230 V AC		
	NAT 1	NO contact: 1, NC contact: 1, white frame, flush-mounted version, 80 x 80 mm	System 55	90400025
	NAT 2 no picture	Function "Emergency Opening" with green knob, NO contact: 1, NC contact: 1, max. load current: 10 A at 230 V AC, white frame, flush-mounted version, 80 x 80 mm	System 55	90400035
	NAT 4	NO contact: 1, NC contact: 1, surface-mounted version, 68 x 68 mm		05027031332
	TL-N S55	Highly-illuminated emergency pushbutton environment with visual locking status indication, optical and acoustic alarm via yellow flashlight and integrated alarm siren, sabotage-proof, behind glass, not including frame NO contact: 1, NC contact: 1, max. load current: 1 A at 24 V DC, flush-mounted version, 80 x 80 mm	System 55	56330500



Trims and boxes for surface-mounted pushbuttons and switches

Designation	Specification	Dimensions in mm (W x H x D)	Installation system	Order No.
System 55	Cover frame (Programm STA)			
FR-S55 1	Single-type trim, Standard 55, white	80.7 x 80.7	System 55	56391110
FR-S55 2	Double-type trim, Standard 55, white	151.8 x 80.7	System 55	56391210
FR-S55 3	Triple-type trim, Standard 55, white	223.3 x 80.7	System 55	56391310
FR-E2W 1	Single-type trim, E2 55, white	80.8 x 80.8	System 55	56392110
FR-E2W 2	Double-type trim, E2 55, white	151.9 x 80.8	System 55	56392210
FR-E2W 3	Triple-type trim, E2 55, white	223.4 x 80.8	System 55	56392310
FR-E2S 1	Single-type trim, E2 55, silver	80.8 x 80.8	System 55	56392101
FR-E2S 2	Double-type trim, E2 55, silver	151.9 x 80.8	System 55	56392201
FR-E2S 3	Triple-type trim, E2 55, silver	223.4 x 80.8	System 55	56392301
FR-E2A 1	Single-type trim, E2 55, anthracite	80.8 x 80.8	System 55	56392115
FR-E2A 2	Double-type trim, E2 55, anthracite	151.9 x 80.8	System 55	56392215
FR-E2A 3	Triple-type trim, E2 55, anthracite	223.4 x 80.8	System 55	56392315







Please see STA price list for further trims and versions.

Active infrared detectors

Safety sensors	Designation	Specification	Colour	Order No.
	Prosecure Opti Scan	The active infrared curtain according EN 16005 ensures optimum protection of the area at the side of the door. It protects people in the danger area of the opening door panel.	black silver coloured white	86301100 86302100 86303100
	Prosecure Opti Scan 1	The active infrared curtain according DIN 18650 and EN 16005 ensures optimum protection of the area at the side of the door. It protects people in the danger area of the opening door panel.	black silver coloured white	86301101 86302101 86303101
Combi sensors	Designation	Specification	Colour	Order No.
	Prosecure Opti Combi	Quick and easy to install, wide field can be used as a light barrier substitute, LCDDisplay, Precise positioning of the AIR curtain thanks to inclination angle display on a clear scale, direction recognition (DIN 18650 and EN 16005)	black silver coloured white	86711400 86712400 86713400
	Prosecure Opti Combi 1	Very flexible field settings, active infrared curtain is self-monitoring, crossing traffic optimization, precise positioning of the AIR curtain thanks to inclination angle display on a clear scale, direction recognition. (DIN 18650 and EN 16005)	black silver coloured white	86711401 86712401 86713401

Motion detectors

	Designation	Specification	Colour	Order-No.
	Prosecure Easy Motion Mono	Full-automatic access on pulse activation; adjustable inclination angle, inclined field of view and field size, LED status indicator Ambient temperature -20 °C to 60 °C	black silver coloured white	86001000 86002000 86003000
	Prosecure Easy Motion Stereo	Adjustable inclination angle, inclined field of view and field size, direction recognition, cross-traffic suppression, immunity, LED status indicator Ambient temperature -20 °C to 60 °C	black silver coloured white	86011000 86012000 86013000
	Prosecure Opti Motion Mono	Adjustable inclination angle, inclined field of view and field size, direction recognition, immunity, LED status indicator Ambient temperature -20 °C to 60 °C	black silver coloured white	86101000 86102000 86103000
	Prosecure Opti Motion Stereo	Adjustable inclination angle, inclined field of view and field size, direction recognition, cross-traffic suppression, Slow Motion function, immunity, LED status indicator Ambient temperature -20 °C to 60 °C	black silver coloured white	86111000 86112000 86113000
Accessories	Designation	Specification		Order-No.
	Rain protection cover	For Easy Motion detectors		86031900
	Rain protection cover/ceiling angle bracket	For Opti Motion detectors		86131900
	Prosecure Remote Control	Remote control for programming Prosecure Opti motion detectors or products from other brands; for the convenient and exact adjustment of high-mounted sensors; self-explaining menu navigation, LCD display Ambient temperature -20 °C to 60 °C		86991900

Our Sustainability Commitment

We are committed to foster a sustainable development along our entire value chain in line with our economic, environmental and social responsibilities toward current and future generations. Sustainability at product level is an important, future-oriented approach in the field of construction. In order to give quantified disclosures of a product's environmental impact through its entire life cycle, dormakaba provides Environmental Product Declarations (EPD), based on holistic life cycle assessments.

www.dormakaba.com/sustainability



Our offering

Access Automation Solutions

Entrance Automation
Entrance Security



Access Control Solutions

Electronic Access & Data
Escape and Rescue Systems
Lodging Systems



Access Hardware Solutions

Door Closers
Architectural Hardware
Mechanical Key Systems



Services

Technical Support
Installation and commissioning
Maintenance and Repair



WN 05405651532, EN, 10/2023
Subject to change without notice



dormakaba.com

dormakaba
International Holding AG
Hofwissenstrasse 24
CH-8153 Rümlang
T +41 44 818 90 11
info@dormakaba.com
dormakaba.com