

TEMPLATE FOR LOCK BODY

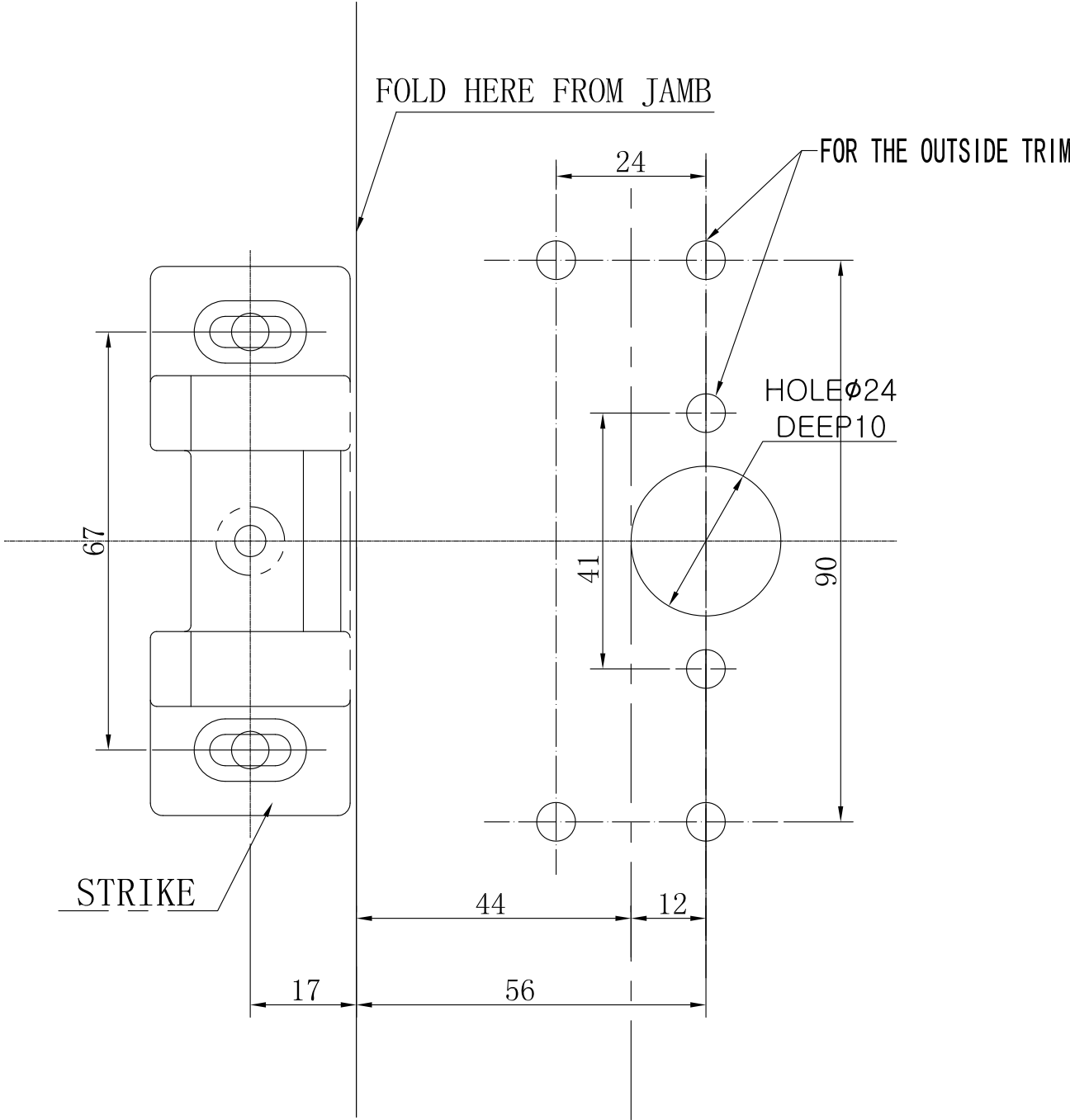

PHA 1302

Drilling template

WN 060000 45532/15027
2021-02

EN

TEMPLATE OF TOP LATCH AND TOP STRIKE

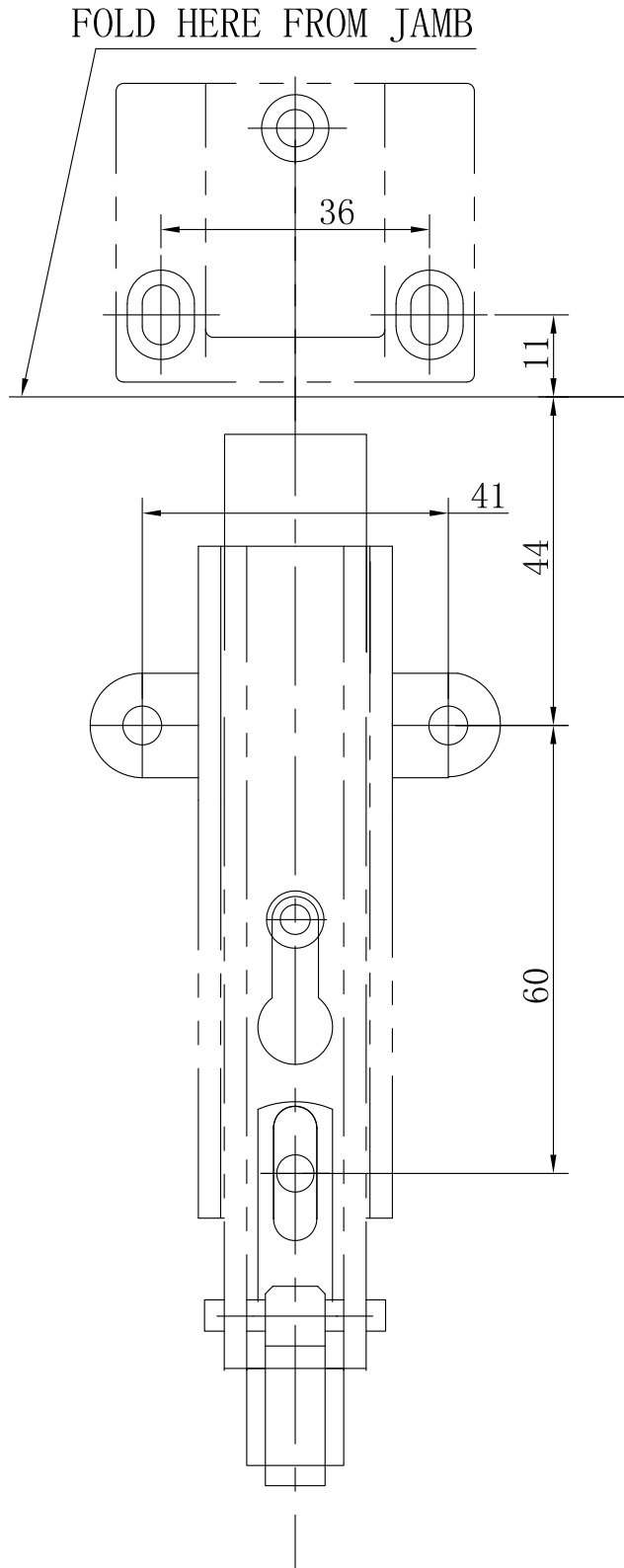

TEMPLATE OF BOTTOM LATCH AND BOTTOM STRIKE

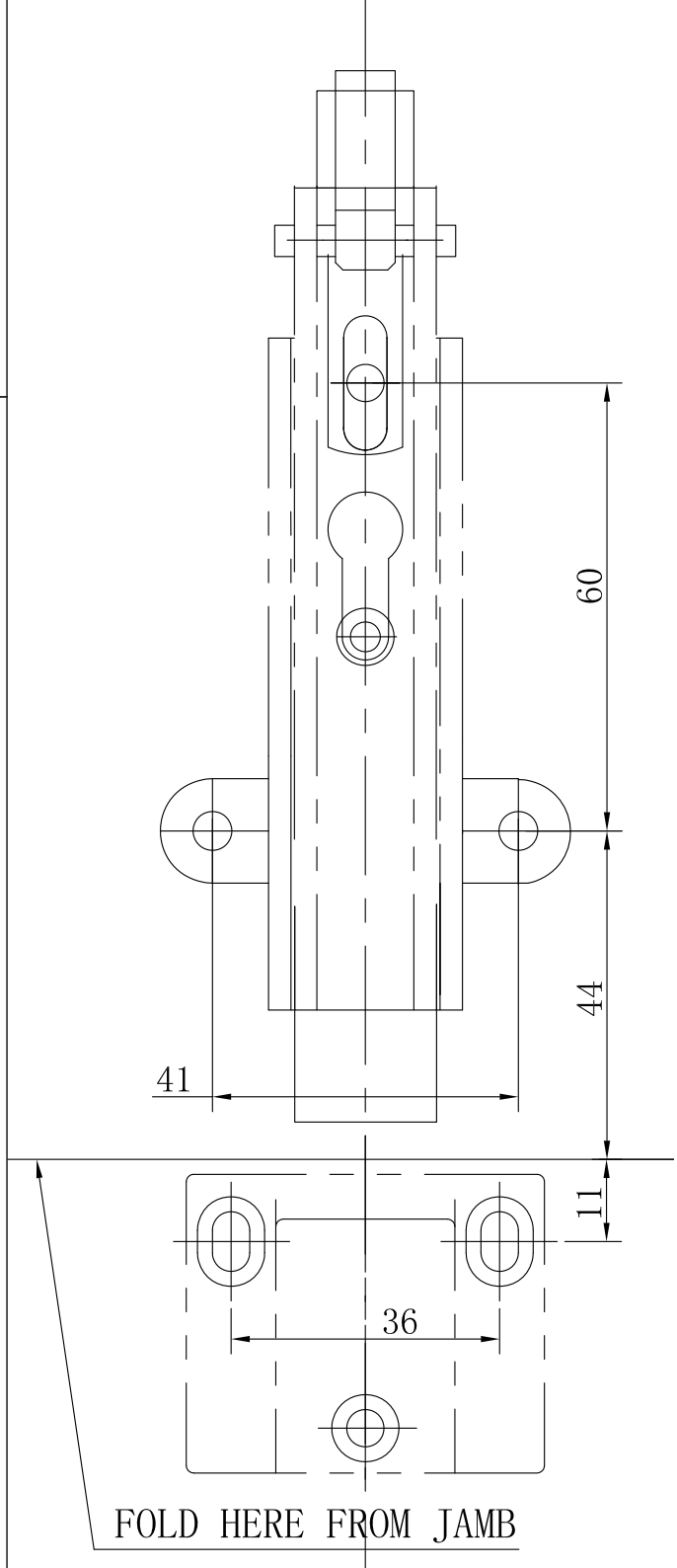

Original manual, subject to change without notice

dormakaba Deutschland GmbH

DORMA Platz 1

58256 Ennepetal

Deutschland

T: +49 2333 793-0

F: +49 2333 793-4950

www.dormakaba.com