



Exit Device

DORMA 8000

DORMA 8000 Series exit devices with deadlocking latch bolts minimize forced entry while offering a low-cost solution to life safety requirements.

Certification:

- Certified/listed to ANSI/BHMA 156.3, Grade 1 for exit devices.
- U.L. and C.U.L. listed under their continuing reinspection programs and conforms to standards U.L. 10C positive pressure testing.
- Complies with NFPA 101 life safety code. Fire rated devices comply with NFPA 80 fire doors and windows.
- Devices, trim, pulls, and levers comply with the Americans with Disabilities Act, 1994, and ANSI 117.1-2003 for accessible and usable buildings and facilities.
- Contributes to U.S. Green Building Council, LEED MR Credits 2.1, 4.1, 4.2 and 5.1.
- Listed with the California Department of Forestry and Fire Protection, Office of the State Fire Marshal.
- Hurricane code approved to Miami-Dade County Florida acceptance No. 06-912.04.

Specifications:

All exit devices shall be DORMA 8000 Series rim, surface vertical rod or surface vertical rod "less bottom rod" devices. All device touchbars, rails and integral parts shall be constructed of solid steel with ABS thermoplastic end caps and covers. Non-labeled units to have hex-key dogging standard. Fire rated versions shall be available for labeled applications. All surface vertical rod devices shall have pullman type latch bolts for the top latch with a round slide bolt bottom latch. All units shall offer trim options ranging from no trim, exit only blank trim, entrance by trim when touchbar is dogged, entrance when latch bolt is retracted by key and entrance by lever set with a key to lock and unlock lever. Device touchbar, rail and rods shall be available with a powder coated finish or base material stainless steel.

Optional Specifications:

Non-labeled devices to have cylinder dogging. Mortise cylinder included.

All surface vertical rod devices to have pullman type bottom latch bolt.

All surface vertical rod devices to have extended top rod.

All surface vertical rod devices to be available less bottom rod.

Devices to have monitor switch in the touchbar to provide local and/or remote notification when the touchbar is depressed.

Devices to have electric bolt retraction to provide remote access from the secure side of the door. Can also be used in conjunction with an automatic door operator.

Devices to have latch monitor for monitoring the latch bolt status.

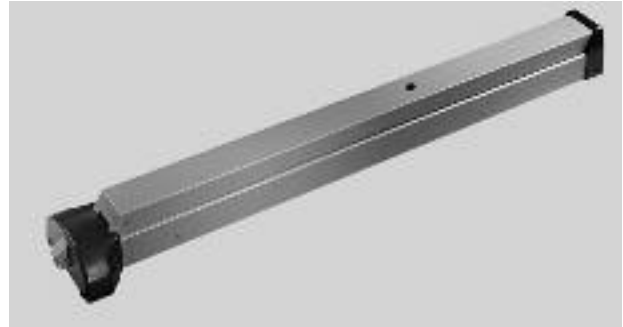

Devices to have one of the following exit alarm options: battery powered exit alarm, battery powered exit alarm with a four minute reset, or direct wired exit alarm.

Devices to use a glass lite shim kit to raise the device from the door surface and avoid glass lite molding.

All labeled wood or composite door devices must use sex bolts.

Exit Device Finishes:

NOTE: All Exit Device Finishes are powder coated except 630 (Satin Stainless), which is manufactured from stainless steel base materials. Covers and end caps are black ABS thermoplastic.

Powder Coated Finishes:

Aluminum: 689.

Bronze: 691 (Dull) or 695 (Dark Duranodic).

Black: 693.

Gold: 696.

Clear Powder Coating: Specify **P**.

Trim Finishes:

NOTE: All trim is powder coated to match exit device, except K and R trims on 689 (Aluminum) or 630 (Satin Stainless) exit devices, which are furnished in 626 (Satin Chrome) or 689 (Aluminum).

Powder Coated Finishes:

Aluminum: 689.

Bronze: 691 (Dull) or 695 (Dark Duranodic).

Black: 693.

Chrome: 626 (Satin).

Gold: 696.

Clear Powder Coating: Specify **P**.

Antimicrobial Protected Coating: Specify **AM**.

Warranty:

For details, refer to **Limited Warranty Policy** in the current DORMA Price List.



The quality management system at the Steeleville, IL facility is certified to ISO-9001:2008.*



*DORMA Door Controls Inc., dba: DORMA Architectural Hardware

Options:

- (BPA) Battery Powered Exit Alarm
- (BPAR) Battery Powered Exit Alarm, (4) minute reset
- (DWA) Direct Wired Exit Alarm
- (CD) Cylinder Dogging
- (ES) Latch Retraction
- (ETR) Top Rod Extension – vertical rod only
- (GK8000) Glass Lite Shim Kit
- (LB) Less Bottom Rod – vertical rod only
- (LM) Latch Monitor
- (MS) Monitor Switch
- (PB) Pullman Bottom Latch – vertical rod only
- (SNB) Sex Nuts – specify quantity
- (R) Rigid Trim
- (HC) Hurricane Code Rated

Features	Model 8300	Model 8400
U.L. Listed for Hazard	•	•
U.L. Listed for Labeled Fire Doors (prefix F)	○	○
Size “A” Doors 34” – 48” Wide	•	•
Size “B” Doors 28” – 36” Wide	•	•
Size “C” Doors 22” – 36” Wide	•	•
Door Height up to 7’	NA	•
Door Height up to 8’	NA	○
Door Height up to 10’ (specify ETR)	NA	○
Door Thickness 1-3/4” to 2-1/4”	•	•
Device Non-Handed	•	NA
Device Handed but Field-Reversible	NA	•
Rigid Trim (specify suffix R)	○	○
Hex Key Dogging (nonfire-rated units only)	•	•
Cylinder Dogging (nonfire-rated units only)	○	○
Round Bottom Slide Bolt (specify SB)	NA	•
Deadlocking Pullman Type Bottom Latch Bolt (specify PB)	NA	○
Less Bottom Rod (specify LB)	NA	○
Glass Lite Shim Kit (specify GK8000)	○	○
Electric Latch Bolt Retraction (specify ES)	○	○
Monitor Switch in Touchbar (specify MS)	○	○
Latch Monitor (specify LM)	○	○
Exit Alarm (specify BPA, BPAR or DWA)	○	○
Sex Nuts (specify SNB/Quantity)	○	○
Hurricane Code Rated (specify HC)	○	○

• – Standard Feature ○ – Optional Feature NA – Not Applicable

ANSI Function	Function Description	Type 1 Rim Exit Device	Type 2 Surface Vertical Rod Exit Device
01	Exit Only – No Trim	8300 or F8300	8400 or F8400
02	Entrance by trim when actuating bar is locked down.	8300 × (trim) 8PDT/8P02/80DTP R02R/C02R PTS02/PRS02	8400 × (trim) 8PDT/8P02/80DTP R02R/C02R PTS02/PRS02
03	Entrance by trim when latch bolt is retracted by key. Key removable only when locked.	8300 or F8300 × (trim) 8P02/8003/8P03/8003P K03/K03J/R03/R03J/C03/C03J/G03/G03J NPS03/PTS03/PRS03	8400 or F8400 × (trim) 8P02/8003/8P03/8003P K03/K03J/R03/R03J/C03/C03J/G03/G03J NPS03/PTS03/PRS03
04	Entrance by trim when latch bolt is retracted by key or set in retracted position by key.	CD8300 × (trim) 8P02/8003/8P03/8003P K03/K03J/R03/R03J/C03/C03J/G03/G03J NPS03/PTS03/PRS03	CD8400 × (trim) 8P02/8003/8P03/8003P K03/K03J/R03/R03J/C03/C03J/G03/G03J NPS03/PTS03/PRS03
05	Entrance by thumbpiece. Key locks or unlocks thumbpiece.	8300 or F8300 × (trim) HTS05/HRS05	8400 or F8400 × (trim) HTT05/HRT05
06	Entrance by thumbpiece only when released by key. Key removable only when locked.	8300 or F8300 × (trim) HTS06/HRS06	8400 or F8400 × (trim) HTT06/HRT06
08	Entrance by knob or lever. Key locks or unlocks knob or lever.	8300 or F8300 × (trim) K08/K08J/R08/R08J/C08/C08J/G08/G08J	8400 or F8400 × (trim) K08/K08J/R08/R08J/C08/C08J/G08/G08J
22	Entrance by thumbpiece (no cylinder). Trim always active.	8300 or F8300 × (trim) HTS22/HRS22	8400 or F8400 × (trim) HTT22/HRT22
23	Entrance by knob or lever (no cylinder). Trim always active.	8300 or F8300 × (trim) R23/C23/K23/G23	8400 or F8400 × (trim) R23/C23/K23/G23

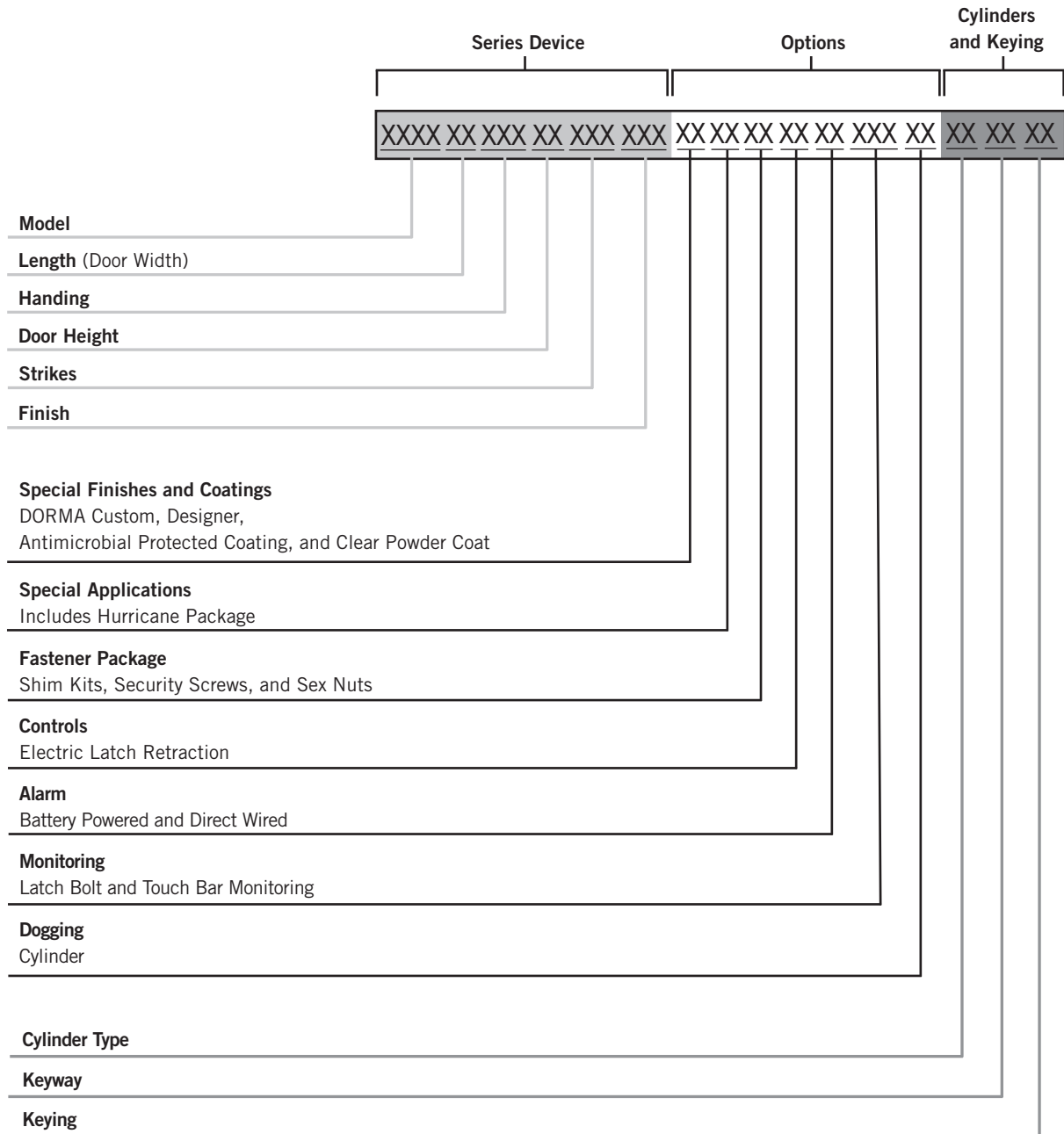

Handing

Right-Hand Reverse Bevel (RHR)

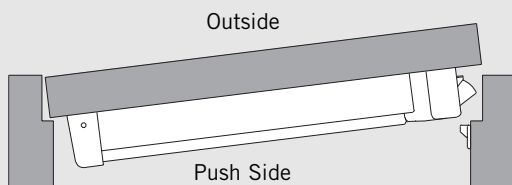

Left-Hand Reverse Bevel (LHR)

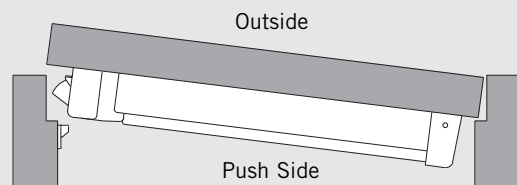

Model	Door Material	Max. Door Opening	Door Ratings	Applications
-------	---------------	-------------------	--------------	--------------

Single Doors

Rim 8300	Wood/Steel	4' x 8'	Devices are panic listed only	Surface applied (1) point latching	
Rim F8300	Steel	4' x 8'	3 Hour		
	Wood	4' x 8'	1-1/2 Hour		
Surface Vertical Rod 8400	Wood/Steel	4' x 10'	Devices are panic listed only	Surface applied (2) point latching	
Surface Vertical Rod F8400	Steel	4' x 10'	3 Hour		
	Wood	4' x 10'	1-1/2 Hour ³		
Surface Vertical Rod (Less Bottom Rod) 8400 LB	Wood/Steel	4' x 10'	Devices are panic listed only	Surface applied (1) point latching	
Surface Vertical Rod (Less Bottom Rod) F8400 LB	Steel	4' x 10'	3 Hour		
	Wood	4' x 10'	1-1/2 Hour ³		

Pair of Doors with Removable Mullion

Rim x Rim 8300 x 8300	Wood/Steel	8' x 8'	Devices are panic listed only	(2) independent active doors with removable mullion (1) point latching	
Rim x Rim F8300 x F8300	Steel	8' x 8'	3 Hour		
	Wood	8' x 8'	1-1/2 Hour		

Pair of Doors

NOTE: A pair of doors using a Rim x Surface Vertical Rod are panic listed only for an 8' x 8' maximum opening.

Surface Vertical Rod 8400 x 8400	Wood/Steel	8' x 10'	Devices are panic listed only	 (swing same direction)	
Surface Vertical Rod F8400 x F8400	Steel	8' x 10'	1-1/2 Hour ²		
	Wood	8' x 8'	1-1/2 Hour		
	Wood	8' x 10'	1-1/2 Hour ³		
Surface Vertical Rod 8400 x 8400	Wood/Steel	8' x 10'	Devices are panic listed only	 (swing opposite direction)	
Surface Vertical Rod F8400 x F8400	Steel	8' x 10'	3 Hour		
	Wood	8' x 8'	1-1/2 Hour		
	Wood	8' x 10'	1-1/2 Hour ³		
Surface Vertical Rod (Less Bottom Rod) 8400 LB x 8400 LB	Wood/Steel	8' x 10'	Devices are panic listed only	 (swing same direction)	
Surface Vertical Rod (Less Bottom Rod) F8400 LB x F8400 LB	Steel	8' x 10'	1-1/2 Hour ^{1,2}		
	Wood	8' x 10'	1-1/2 Hour ^{1,3}		
Surface Vertical Rod (Less Bottom Rod) 8400 LB x 8400 LB	Wood/Steel	8' x 10'	Devices are panic listed only	 (swing opposite direction)	
Surface Vertical Rod (Less Bottom Rod) F8400 LB x F8400 LB	Steel	8' x 10'	3 Hour ¹		
	Wood	8' x 10'	1-1/2 Hour ^{1,3}		

- Notes:**
1. Fire rated pairs using **Less Bottom Rod** devices require the supplied door popper. With the absence of bottom rods, the popper holds the bottoms of the doors together in the event of fire.
 2. Pairs of doors swinging in the same direction cannot use two vertical rod exit devices with an overlapping astragal. Pairs of doors rated greater than 1-1/2 hours require a steel overlapping astragal. Currently, no door manufacturers offer over 90 min. with doors swinging in the same direction.
 3. Consult wood door manufacturers for current U.L. listings.

Model Number	Function	Operation	Trim Model Numbers	
8300 F8300	01	Exit Only (no trim)		
8300 F8300	DT	Dummy Trim	80DT	NPSDT
8300	02	Entrance by trim when actuating bar is locked down.	8P02 80DTP	8PDT PRS02 PRT02
8300 F8300	03	Entrance by trim when latch bolt is retracted by key. Key removable only when locked.	8P02 8003P	8003 8P03 PRS03 PTS03
CD8300	04	Entrance by trim when latch bolt is retracted by key or set in a retracted position by key.	8P02 8003P	8003 8P03 PRS03 PTS03
8300 F8300	05	Entrance by thumbpiece. Key locks or unlocks thumbpiece.		HRS05 HTS05
8300 F8300	06	Entrance by thumbpiece only when released by key. Key removable only when locked.		HRS06 HTS06
8300 F8300	08	Entrance by knob or lever. Key locks or unlocks knob or lever.		K03 K03J R03 R03J C03 C03J G03 G03J
8300	22	Entrance by thumbpiece (no cylinder). Trim always active.		HRS22 HTS22
8300 F8300	23	Entrance by knob or lever (no cylinder). Knob or lever always active.		K23 R23 C23 G23

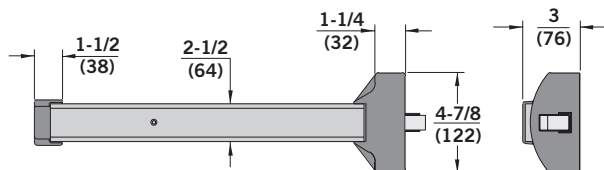

Standard Strike

No.463

Standard strike with 8300 and F8300

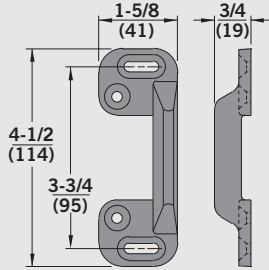

Trim	* Minimum Stile
No Trim, 8P02	4 (102)
8PDT, 8P03	4 (102)
8ODT, 8ODTP 8003, 8003P	4-1/2 (114)
K, R, C	4-7/16 (113)

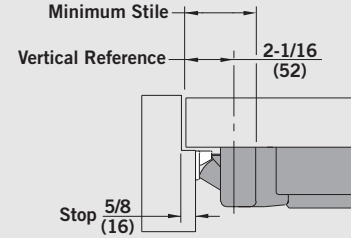

Optional Strikes

No.430

Box strike with 8300

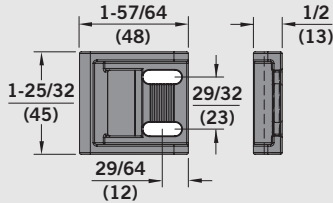

Trim	* Minimum Stile
No Trim, 8P02	3-13/16 (97)
8PDT, 8P03	4-1/8 (105)
8ODT, 8ODTP 8003, 8003P	4-7/16 (113)
K, R, C	4-1/4 (108)

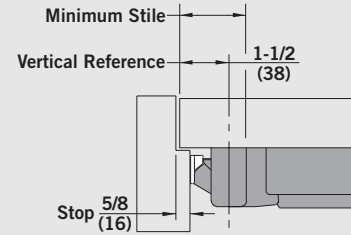

No. 486

Roller strike

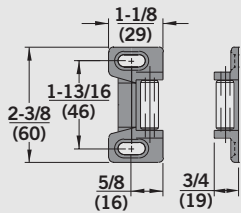

Trim	* Minimum Stile	Vertical Reference
No Trim, 8P02	4 (102)	2-1/16 (52)
8PDT, 8P03	4 (102)	2-1/16 (52)
8ODT, 8ODTP 8003, 8003P	4-1/2 (114)	2-1/16 (52)
K, R, C	4-7/16 (113)	2-1/16 (52)

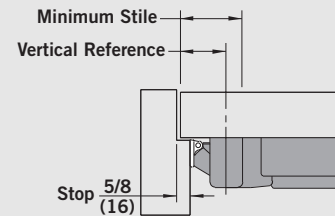

No.320

Overlap strike

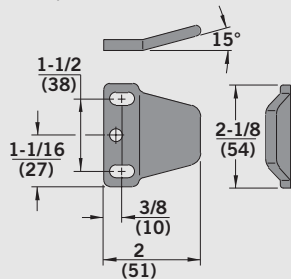





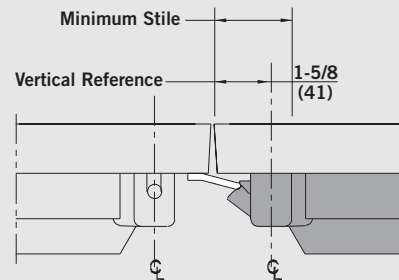

























Not Fire Rated

Trim	* Minimum Stile
No Trim, 8P02	4-1/16 (103)
8PDT, 8P03	4-1/16 (103)
8ODT, 8ODTP 8003, 8003P	4-1/16 (103)
K, R, C	4 (102)



* Minimum stile dimensions accommodate standard device touchbar widths shown. For smaller stiles, consult factory for optional touchbar lengths.

Model Number	Function	Operation	Trim Model Numbers		
8400 F8400	01	Exit Only (no trim)			
8400 F8400	DT	Dummy Trim	80DT 	NPSDT 	
8400	02	Entrance by trim when actuating bar is locked down.	8P02  80DTP 	8PDT  PRS02 PRT02 	R02R  C02R G02R
8400 F8400	03	Entrance by trim when latch bolt is retracted by key. Key removable only when locked.	8P02  8003P 	8003  8P03  PRS03 PTS03 	NPS03  K03 K03J  R03 R03J  C03 G03 C03J G03J
CD8400	04	Entrance by trim when latch bolt is retracted by key or set in a retracted position by key.	8P02  8003P 	8003  8P03  PRS03 PTS03 	NPS03  K03 K03J  R03 R03J  C03 G03 C03J G03J
8400 F8400	05	Entrance by thumbpiece. Key locks or unlocks thumbpiece.		HRS05 HTS05 	
8400 F8400	06	Entrance by thumbpiece only when released by key. Key removable only when locked.		HRS06 HTS06 	
8400 F8400	08	Entrance by knob or lever. Key locks or unlocks knob or lever.			K08 K08J  R08 R08J  C08 G08 C08J G08J
8400	22	Entrance by thumbpiece (no cylinder). Trim always active.		HRS22 HTS22 	
8400 F8400	23	Entrance by knob or lever (no cylinder). Knob or lever always active.			K23  R23  C23 G23

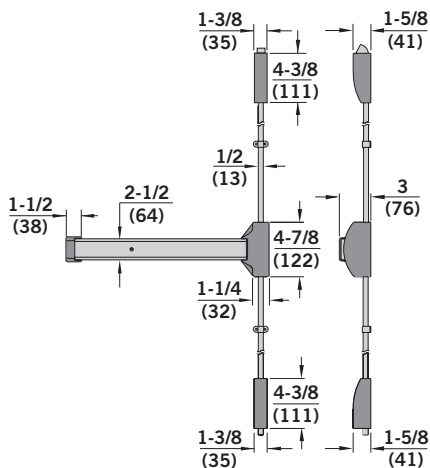

Standard Strikes

No.426

Top strike 8400, F8400, 8400 LB and F8400 LB

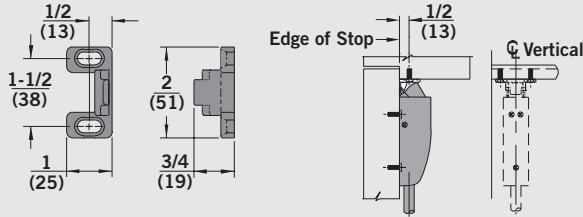

No.439

Bottom strike 8400 and F8400

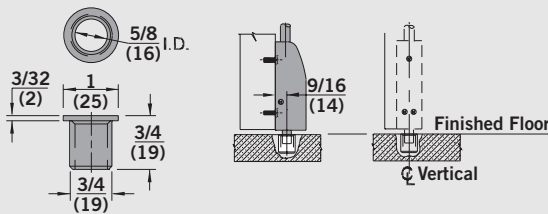

Minimum Stile and Vertical Reference

Vertical Rod x Vertical Rod

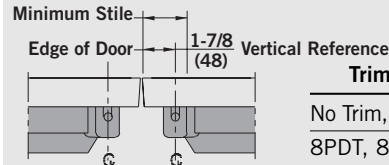

Trim	*Minimum Stile
No Trim, 8P02	3-13/16 (97)
8PDT, 8P03	3-13/16 (97)
8ODT, 8003, 8003P	4-5/16 (110)
K, R, C	4-1/4 (108)

Vertical Rod x Rim

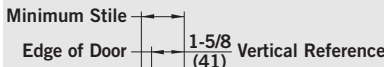

Not Fire Rated

Trim	*Minimum Stile
No Trim, 8P02	4-1/16 (103)
8PDT, 8P03	4-1/16 (103)
8ODT, 8003, 8003P	4-1/16 (103)
K, R, C	4 (102)

Optional Strikes

No.340

For bottom slide bolt.

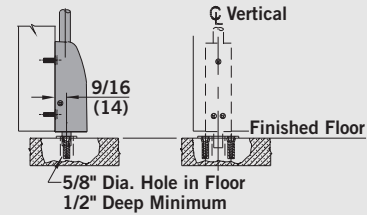
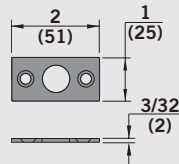

No.431

Used with optional pullman type latch bolt.

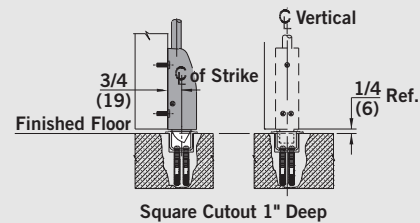
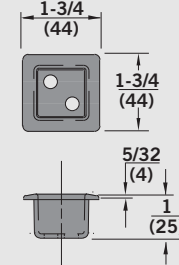

No.416V

Used with optional pullman type latch bolt.

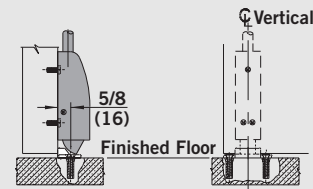
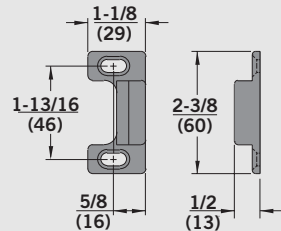

No.426A

For flush door and frame conditions.

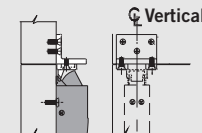
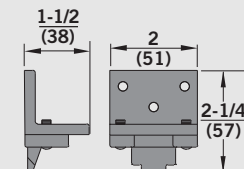

*Minimum stile dimensions accommodate standard device touchbar widths shown. For smaller stiles, consult factory for optional touchbar lengths.

How to Order

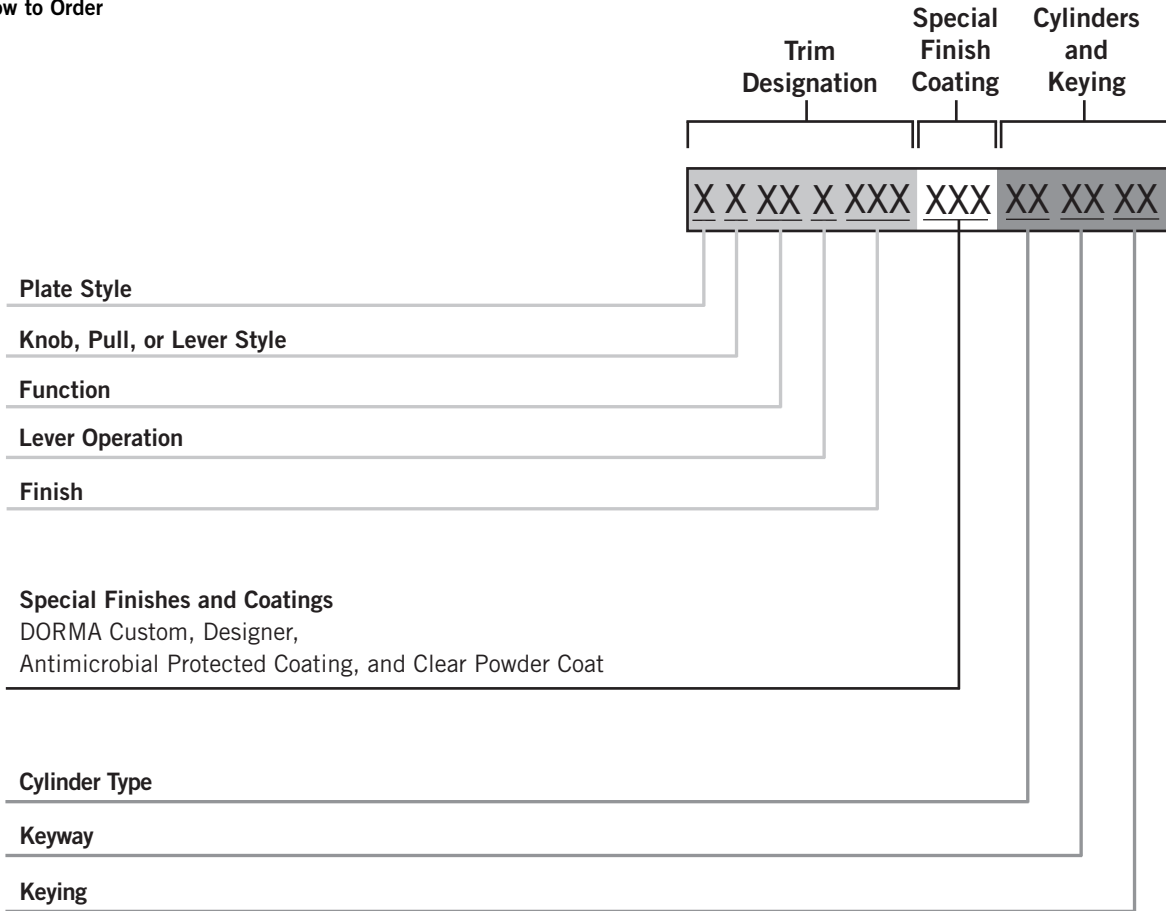

Patented Key Control
D100 is the keyway for DORMA's patented **SKC** serialized key control system. **SKC** is internet based and provides added layers of security. For more information, contact your local DORMA sales representative or DORMA Technical Service at 800-523-8483.

Lever and Knob Styles



C



G





K



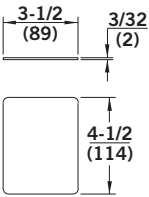
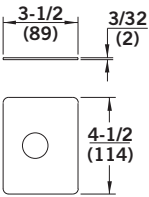
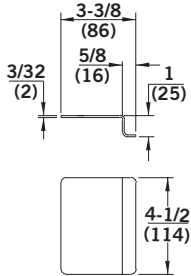

R

Trim

			
			
Trim Descriptions	Flat Plate Dummy Trim	Flat Plate with Cylinder Hole	Offset Pull
Trim Designation	80DT	8003	8PDT
Handing	—	—	—
Function	02	03 or 04 (with CD device)	02
DORMA Cylinder (default)	—	80R10SC – Rim	—
DORMA Cylinder (optional SFIC)	—	87R10BA – 7-pin	—

Trim

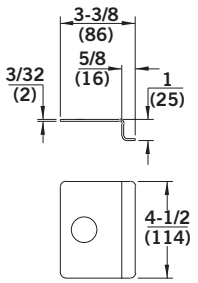
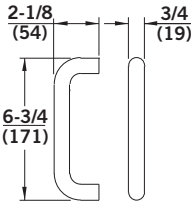
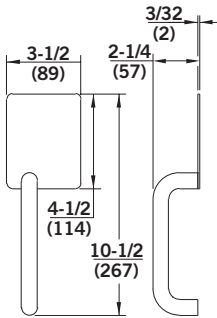
			
			
Trim Descriptions	Offset Pull with Cylinder Hole	Tubular Pull	Flat Plate with Tubular Pull
Trim Designation	8P03	8P02	80DTP
Handing	—	—	Specify Hand
Function	03 or 04 (with CD device)	02, 03 or 04 (with CD device)	02
DORMA Cylinder (default)	80R10SC – Rim	—	—
DORMA Cylinder (optional SFIC)	87R10BA – 7-pin	—	—

Trim

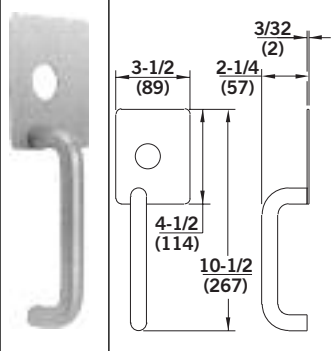
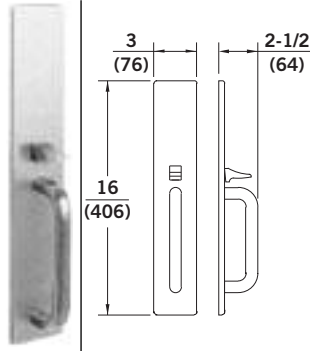
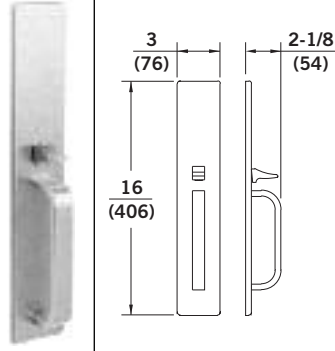
			
Trim Descriptions	Flat Plate with Tubular Pull and Cylinder Hole	Wide Flat Plate Tubular Pull with Thumbpiece	Wide Flat Plate Rectangular Pull with Thumbpiece
Trim Designations	8003P	HTS22	HRS22
Handing	Specify Hand	—	—
Function	03 or 04 (with CD device)	22	22
DORMA Cylinder (default)	80R10SC – Rim	—	—
DORMA Cylinder (optional SFIC)	87R10BA – 7-pin	—	—

Trim

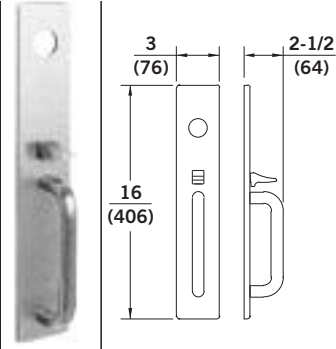
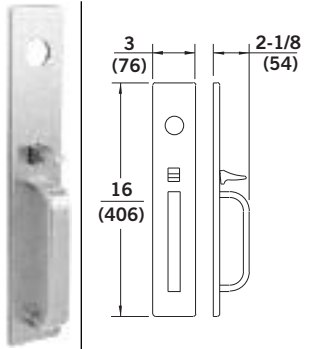
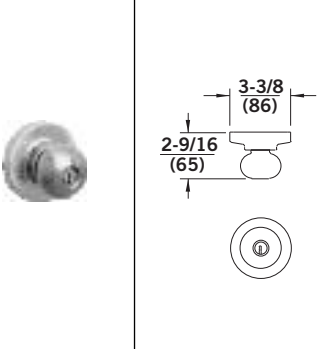
			
Trim Descriptions	Wide Flat Plate Tubular Pull with Thumbpiece and Cylinder Hole	Wide Flat Plate Rectangular Pull with Thumbpiece and Cylinder Hole	Key-in Knob
Trim Designation	HTS05, HTS06	HRS05, HRS06	K03, K08
Handing	—	—	—
Function	05 or 06	05 or 06	03 or 08
DORMA Cylinder (default)	90X10SC118 – Mortise	90X10SC118 – Mortise	Includes DORMA key-in-knob cylinder 7013SC KD
DORMA Cylinder (optional SFIC)	97A10BA138 – 7-pin	97A10BA138 – 7-pin	—

Trim

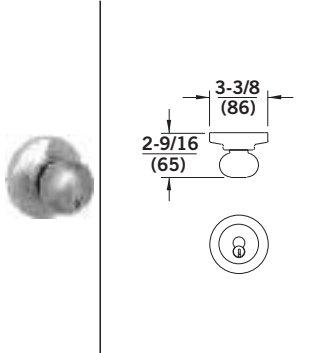
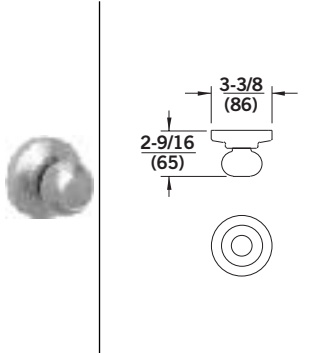
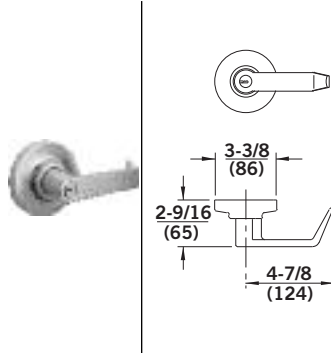
			
Trim Descriptions	Key-in Knob Interchangeable Core	Knob	Key-in-Rectangular Lever
Trim Designation	K03J, K08J	K23	R03, R08
Handing	—	—	—
Function	03 or 08	23	03 or 08
DORMA Cylinder (default)	Accepts SFIC	—	Includes DORMA key-in-lever cylinder 7013SC KD
DORMA Cylinder (optional SFIC)	77BAxxx – 7-pin	—	—

Trim

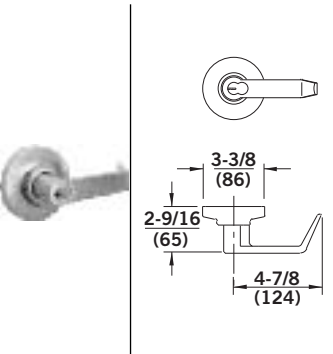
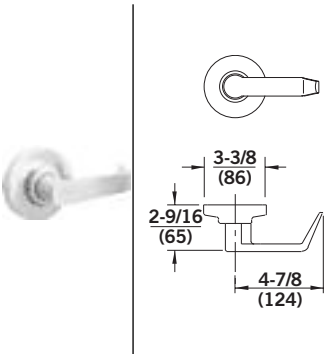
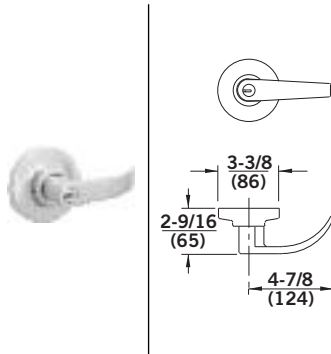
			
Trim Descriptions	Key-in-Rectangular Lever Interchangeable Core	Rectangular Lever	Key-in-Curved Lever
Trim Designation	R03J, R08J	R02R, R23	C03, C08
Handing	—	—	—
Function	03 or 08	02 or 23	03 or 08
DORMA Cylinder (default)	Accepts SFIC	—	Includes DORMA key-in-lever cylinder 7013SC KD
DORMA Cylinder (optional SFIC)	77BAxxx – 7-pin	—	—

Trim

Trim Descriptions	Key-in-Curved Lever Interchangeable Core	Curved Lever
Trim Designation	C03J, C08J	C02R, C23
Handing	—	—
Function	03 or 08	02 or 23
DORMA Cylinder (default)	Accepts SFIC	—
DORMA Cylinder (optional SFIC)	77BAxxx – 7-pin	—

Trim

Trim Descriptions	Key-in-Straight Lever	Key-in-Straight Lever interchangeable Core	Straight Lever
Trim Designation	G03, G08	G03J, G08J	G02R, G23
Handing	—	—	—
Function	03 or 08	03 or 08	02 or 23
DORMA Cylinder (default)	Includes DORMA key-in-lever/ knob cylinder 7013SC KD	Accepts SFIC	—
DORMA Cylinder (optional SFIC)	—	77BAxxx – 7-pin	—

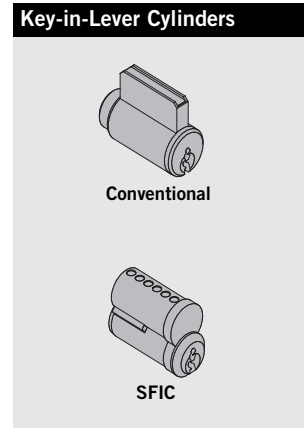
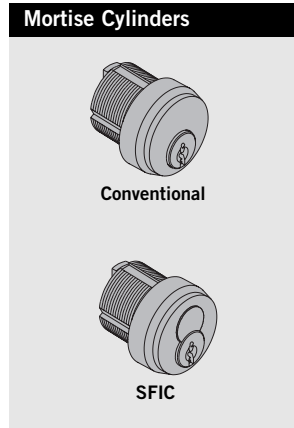
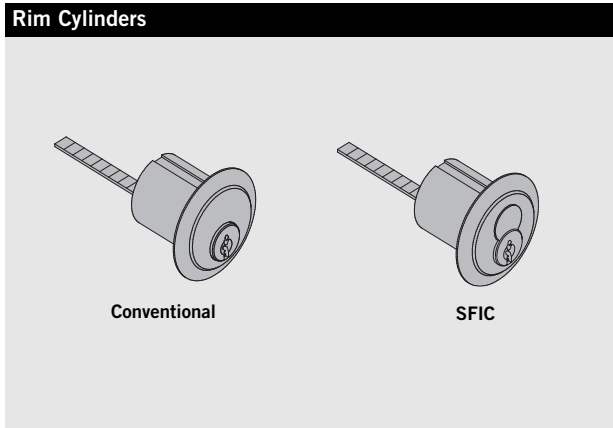

Application	ANSI Function	Cylinder Type	Conventional (Default)	SFIC 7-Pin
Cylinders for 8300/F8300 Rim and 8400/F8400 Surface Vertical Rod Devices				
Sectional Trim (Key-in-Lever)	03, 04, 08	Key-in-lever	7013SC	77BA
Wide Plate Trim	03, 04	Rim	80R20SC	87R20BA
Wide Plate Trim	05, 06	Mortise	90X10SC118	97C10BA138
Pulls	03, 04	Rim	80R20SC	87R20BA
Cylinders for Device Options				
CD, BPA, BPAR		Mortise	90X10SC118	97D10BA138
Cylinders for Mullions				
1340KR Key Removable Mullion		Mortise	90X01SC118	97D01BA138
1340SK Mullion Storage Kit		Mortise	90X01SC118	97D01BA138

Sex Nuts

The information below serves as a simple reference when specifying DORMA 8000 Series exit devices and trim (two per pack).

8300/F8300	3 packs
8300/F8300 w/trim	1 pack
8400/F8400	5 packs
8400/F8400 w/trim	4 packs

GK8000 Glass Lite Shim Kit

Kit contains two 1/8" thick shims. Permits shimming of the exit device maximum 1/4" off door face without affecting U.L. listing. Designed to accommodate glass lite installed in door. Furnished bright zinc plated. Optional finishes available, consult factory.

Optional Electrical Functions

Electric Latch Bolt Retraction – Specify prefix **ES**.

A solenoid concealed in the touchbar assembly provides instantaneous retraction of the latch bolt to allow access from the secure side of the door. Remote control can be accomplished with switching devices such as key switches and card readers that provide a normally open electrical contact. The solenoid is rated for continuous duty, 24 VDC, 5 AMP inrush for 350 milliseconds, .21 AMP holding current.

Requires ES100 power supply and ES105 power transfer.

ES100 Power Supply

The ES100 Power Supply is capable of powering and controlling (2) 8000 Series Panic Devices with the ES Electric Latch Bolt Retraction feature.

- Input: 120 volts
- Input circuit protection: 1.3 AMP fuse
- Output: 24 VDC, 6 AMP surge for 0.5 seconds, .65 AMP continuous, per zone
- Output circuit protection: 3 AMP Push to Reset circuit breaker
- Enclosure: 8" high × 8" wide × 4" deep NEMA 1 Type enclosure for indoor use with hinged cover and knock-outs

ES101 Delay Module

The ES101 optional time delay module for the ES100 Power supply delays the relatching of ES series panic devices and has field-adjustable range between 1 second and 60 minutes.

This is a fail-secure option that allows time to enter a door after using a card reader or key switch, or may be required when ES Series panic devices are used in conjunction with an automatic door operator.

ES103 Relay Module

The ES103 optional relay module is a double pole, double throw relay with screw terminal connections. This coil rating is .025 AMP @ 24 VDC. The contact rating is 2.0 AMP @ 30 VDC.

Relays may be wired in parallel if additional contacts are required. This relay may be required to signal other systems such as an automatic door operator.



Monitor Switch – Specify prefix **MS**. A reed switch in the touchbar assembly which provides local and/or remote notification when the touchbar is depressed. Switch is rated for 3 AMP @ 28 VDC.

Latch Monitor – Specify prefix **LM**. A microswitch attached to the device chassis on rated and non-rated 8300, 8400 and 8400 LB. Provides local and/or remote notification of movement of the panic device rods and latch bolt without depressing the touchbar. The switch is a single pole, double throw switch, 0.5 AMP @ 28 VDC maximum.

Battery Alarm Exit Device

The DORMA 8000 Series exit devices are available with an integral battery powered alarm. The 102 decibel alarm contained in the exit device touchbar and rail assembly activates when the touchbar is depressed and sounds continuously until the device is reset or the battery is completely discharged. Alternatively, a factory-furnished option allows the alarm to sound for four (4) minutes, then automatically rearms.

Furnished with and controlled by a lock cylinder and key, the unit allows ten (10) seconds to exit through the door after arming the alarm, indicated by an intermittently flashing red L.E.D. light in the touchbar. A yellow L.E.D. in the touchbar will flash, until manually reset by key, to indicate an unauthorized exit even if the alarm has automatically reset.

The unit is furnished with a 9 volt, industrial-grade battery concealed in the end cap assembly for easy replacement. A tamperproof switch will activate the alarm if unauthorized removal of the battery is attempted. Option is available for 12 or 24 volt direct power wiring.



- Specify prefix **BPA** to 8000 Series model number for battery alarm device.
- Specify prefix **BPAP** for 4 minute auto reset battery alarm device.
- Specify prefix **DWA** for direct hard-wired option.
- Size **A** device fits 48" wide door and can be cut to fit 34" wide doors.
- Size **B** device fits 36" wide door and can be cut to fit 28" wide doors.
- Size **C** device fits 36" wide door and can be cut to fit 22" wide doors.

Removable mullions are used with paired doors where a full-width opening is only occasionally required. Doors are fitted with rim exit devices and normally function as single doors. Available in 8' or 10' lengths.

1310 Aluminum Mullion

- Meets demands of heaviest use areas.
- Durable extrusion.
- Supplied with wood/machine screws and anchors.

1310 - 8 – 8' mullion
1310 - 10 – 10' mullion

1310 - 8 x 443 – 8' mullion with recessed strike
1310 - 10 x 443 – 10' mullion with recessed strike

WS1310 - 8 – 8' mullion with weatherstrip
WS1310 - 10 – 10' mullion with weatherstrip

WS1310 - 8 x 443 – 8' mullion with weatherstrip and recessed strikes

WS1310 - 10 x 443 – 10' mullion with weatherstrip and recessed strikes

Finish:

Aluminum: 628 (Satin).
Bronze: 695 (Dark).

1330 Steel Mullion

- Ideal for high-abuse areas such as schools.
- Meets demands of heaviest use areas.
- Heavy-gauge, smooth-surface steel construction.
- Attractive tube shape with rounded corners.
- Supplied with wood/machine screws and anchors.

1330 - 8 – 8' mullion
1330 - 10 – 10' mullion

Finish:

Prime: 600.

Note: When using a mullion, refer to exit device template for minimum stile and vertical reference dimensions.

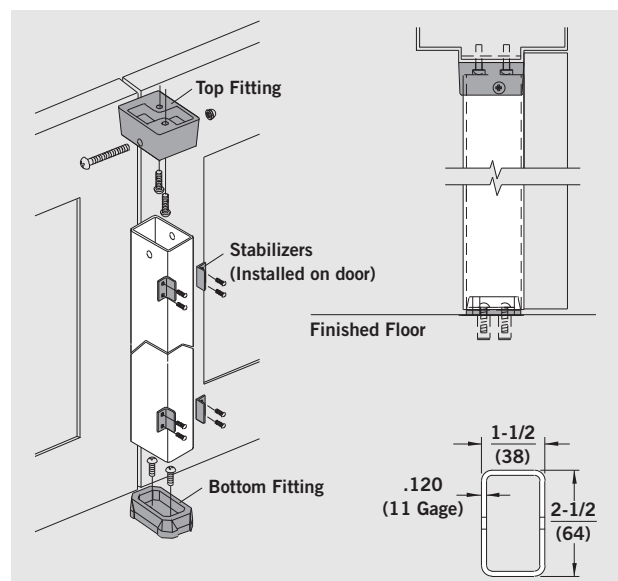
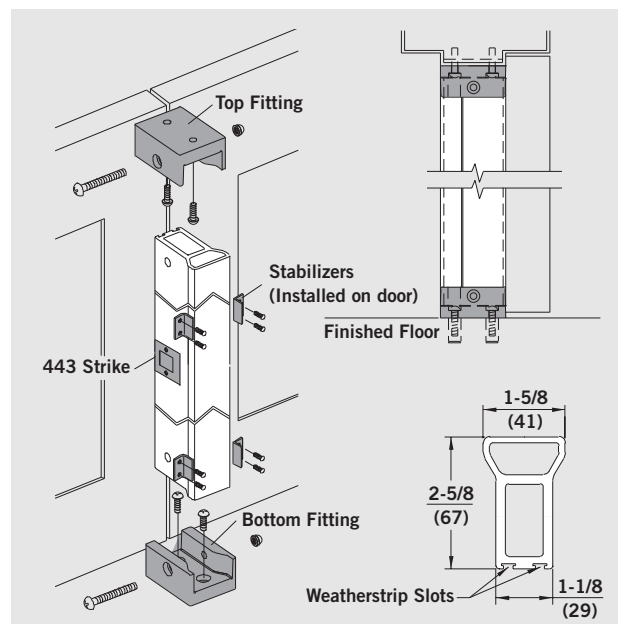
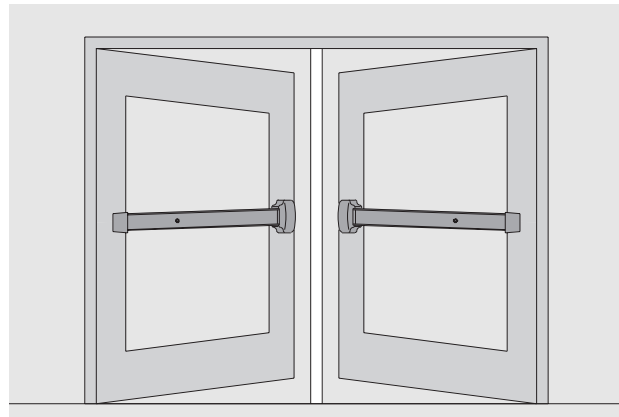

F1300 Steel Mullion

- For use with U.L. listed fire exit devices.
- Meets demands of heaviest use areas.
- Large top and bottom fittings for extra strength.
- Heavy-duty tube with rounded corners.
- Standard 8' length.
- Supplied with wood/machine screws and anchors.

F1300 - 8 – 8' fire-rated mullion
1300 - 8 – 8' non-fire-rated mullion
1300 - 10 – 10' non-fire-rated mullion

Finish:
 Prime: 600.

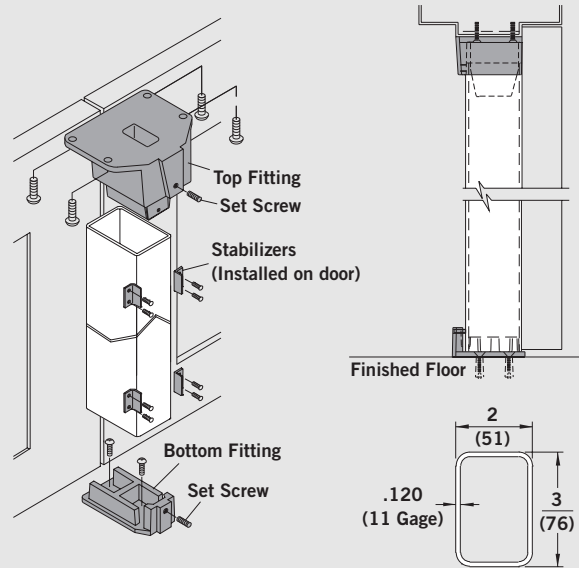

F1340KR Key Removable Steel Mullion

- Easily removable with key.
- Keying is standard 1-1/8" mortise cylinder with O1 (AR) cam.
- For use with U.L. listed fire exit devices.
- Meets demands of heaviest use areas.
- Large top and bottom fittings for extra strength.
- Heavy-duty tube with rounded corners.
- Standard 8' length.
- Supplied with wood/machine screws and anchors.

F1340KR - 8 – 8' fire-rated key removable mullion
1340KR - 8 – 8' non-fire-rated key removable mullion
1340KR - 10 – 10' non-fire-rated key removable mullion

Finish:
 Prime: 600.

Optional DORMA SFIC:
 97D01BA138 – 7-pin

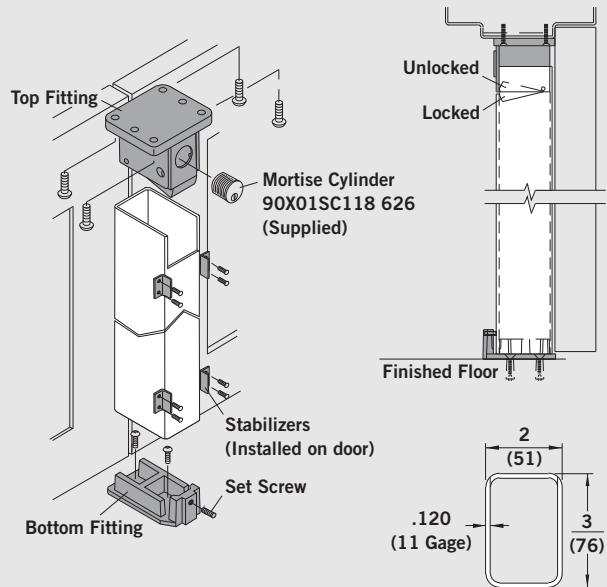

1340SK Mullion Storage Kit

- For use with 1340 mullion.
- Locking cylinder can be keyed into master key system.
- Includes conventional default mortise cylinder: 90X01SC118 626.

Optional DORMA SFIC:
 97D01BA138 – 7-pin



DORMA Americas
www.dorma-usa.com

DORMA Architectural Hardware
DORMA Drive, Drawer AC
Reamstown, PA 17567-0411
Telephone: (800) 523-8483
Facsimile: (800) 274-9724
E-mail: archdw@dorma-usa.com

DORMA Canada
1680 Courtney Park Drive, Unit 13
Mississauga, Ontario L5T 1R4
Telephone: (800) 387-4938
Facsimile: (905) 670-5850
E-mail: sales@dormacanada.com

DORMA Mexico, S. de R.L. de C.V.
Astrónomos 28, Col. Escandón
México, D.F. 11800
Del. Miguel Hidalgo
Telephone: (52+55) 5272-6937
Facsimile: (52+55) 5272-6948
E-mail: operacion@dorma.com.mx