

# INSTALLATION



## EML310/EML320

### Electromagnetic Locks

#### Pre-Installation Instructions

1. This product must be installed according to all applicable building and life safety codes.
2. Due to the variety of mounting configurations available with this product, a survey and assessment of the physical area in which the product will be installed must be performed.
3. The door frame must be inspected and deemed structurally sound prior to installation of the electromagnetic lock. The structural integrity of the mounting surfaces must be strong enough to meet or exceed the holding force of the product.
4. The product must be protected from potential damage due to intruders or tampering.
5. The product should be installed in a location that will not hinder or create a potential safety hazard to authorized personnel accessing the protected area.
6. Because electromagnetic locks are used in a variety of applications and different door frame configurations, an experienced installer with knowledge of this product must make a determination of the optimal mounting method for this specific application.
7. The components, hardware, installation instructions and mounting template included with this product are intended for use on outswinging doors.

PLEASE DELIVER ALL INSTALLATION INSTRUCTIONS TO THE END-USER UPON COMPLETION OF THE INSTALLATION.

8. Do not install this product on the exterior of buildings.
9. Do not use as a doorstop. This will void warranty.
10. Separate accessories not included with this product must be used in the following applications:
  - Inswinging doors
  - Narrow head jamb situations or center-hung doors
  - Wherever there is insufficient space on the door frame header to mount the lock
  - Hollow metal or wood frames where the door stop is not thick enough to allow the product to be installed
  - Wherever an obstruction in the door prevents installation of the armature plate at a proper height
  - Doors that do not permit the armature plate to be mounted low enough to meet the magnet surface

Refer to the Product Accessories Guide section of the Installation Instructions for further information. Accessories may impact holding force.

11. Installation of this product should be done by an experienced installer with knowledge of this product.

**NOTE:** It is highly recommended that thread locking compound be applied to all screws during installation to reduce chance of screws loosening over extended time.

#### Installation Instructions

1. Mount the electromagnetic lock to the door frame as outlined on the installation template included with the product.

**NOTE:** During installation of the armature plate to the door it is essential that the armature plate remains movable. The armature plate must be allowed to pivot on the center-mounting bolt to allow proper alignment with the magnet surface. If the plate is not aligned with the magnet surface, the lock may lose holding force or not lock at all.

The head of the armature mounting bolt ships with a rubber washer affixed to it. This washer should project slightly beyond the surface of the armature plate. This is to allow the washer to expand when power is removed and break the air vacuum between the plate and the magnet surface. If this washer is removed or trimmed the lock will appear to have some holding force even when power is removed.

For added safety, thread locking compound has been provided for the armature plate bolt and the four captive electromagnetic lock mounting screws. (See Fig. 2 on page 2)

**WARNING: Improper installation, maintenance, inspection or usage of the product or any related accessories or parts may cause the electromagnetic lock, armature plate and associated hardware to disengage and fall, causing serious bodily injury and property damage. Dorma will not be liable to the installer, purchaser, end user or anyone else for damage or injury to person or property due to improper installation, care, storage, handling, maintenance, inspection, abuse, misuse or act of God or nature involving this product or any related accessories or parts.**

2. Route the power supply connecting wire through the door frame and into the wire access hole in the top of the magnet housing. Connecting wire should be of sufficient gauge for the lock being installed and the distance being run. See table on page 8 for current draw specifications and wiring gauge chart.

# EML310 & EML320 Electromagnetic Lock Installation Instructions (Continued)

- Once wiring has been routed into the lock cavity, connect wire to terminal blocks as shown in Fig. 1. If optional Bond Alert (BA) and/or Standard Door Position Switch (DP) features are being used these can also be wired at this time as shown in Fig. 1.
- Delayed Relock Feature** - Should the built-in delayed relock feature be required for the installation, a Normally Open Momentary switch such as a Dorma 3909 will need to be installed and connected to the two blue wires from J2 on the circuit board as illustrated in Fig. 1.

The delayed relock feature can be used to momentarily release the lock and keep it unlocked for a time period from 0 to 110 seconds. The time delay for this feature can be adjusted by carefully turning the potentiometer (RW1) in a clockwise direction to increase delay time. Factory setting is zero seconds.

**NOTE:** The clockwise direction is consistent for single and double door models.

If the delayed relock feature is not required the blue wires may be unplugged from the circuit board at J2.

**NOTE:** If RW1 is not set to zero seconds, the lock will enter delayed relock mode each time power is applied even if J2 has been removed.

## 5. Anti-Tamper Feature

Two screws prevent insertion of an Allen wrench into the captive mounting screw opening on the bottom of the lock. Fig. 2 shows their location. One screw also secures the wiring cavity cover. The mounting plate cannot be separated from the lock without removing these two screws.

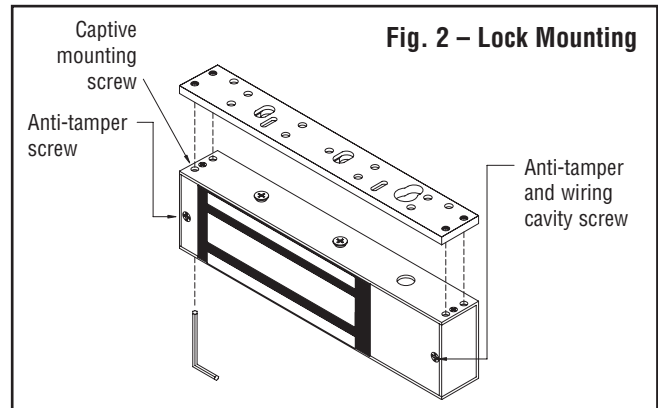

**Fig. 1 - Lock Wiring**

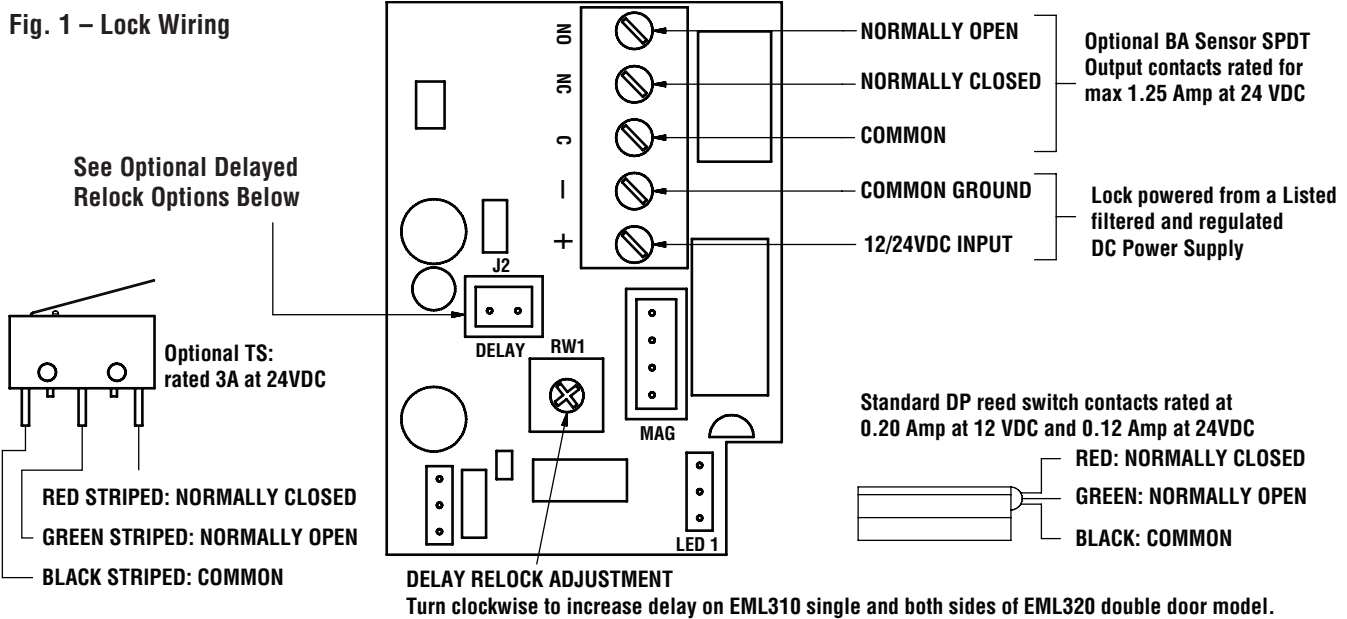

Optional Delayed Relock Options - for use in a delayed-egress locking system, relock must be set to 0 seconds.

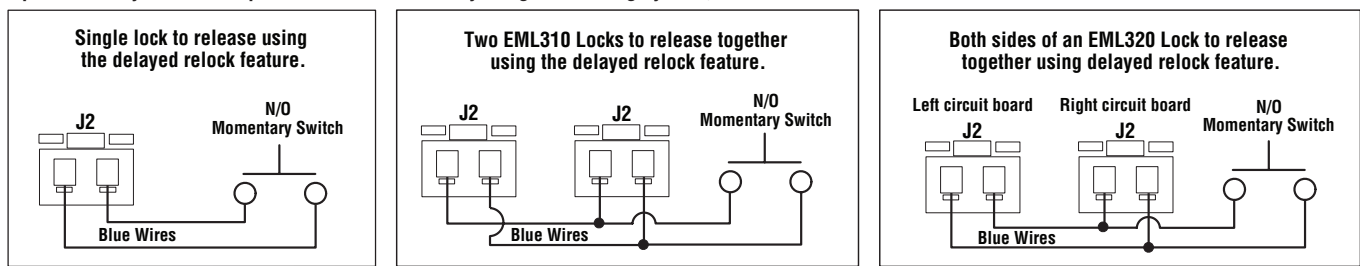

# EML310 & EML320 Electromagnetic Lock Installation Instructions (Continued)

- 6. To Ensure Instant Release** All switching devices must be wired in between the DC power source and the positive terminal of the lock in Fig. 3. Switching the negative power supply line will not allow the lock to release immediately.

These Dorma electromagnetic locks contain TVS for surge suppression and do not require any additional suppression to be added during installation.

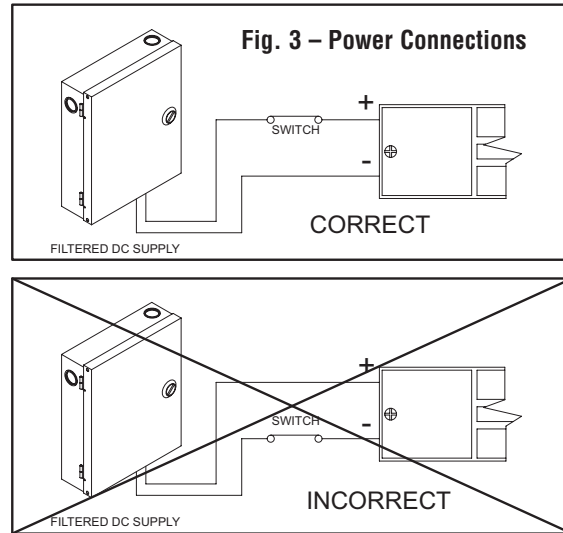

## Lock Monitoring Options

The EML310 and EML320 locks can be equipped with remote indication features that operate as follows. Each of these features will provide indication as to the lock status. See Fig.1 for wiring diagram.

### BA – Bond Alert Sensor

This option can detect the quality of the locking bond between the surface of the magnet and the armature plate. The sensitivity of this option is such that a foreign object with a thickness of .007” (.18mm) is sufficient to allow the sensor to detect a problem.

Due to the sensitivity of this option and the necessity to maintain a reliable locking bond, these surfaces must be kept free of contaminating materials. Both the lock surface and the armature plate must be cleaned periodically with a non-abrasive cleanser. Alignment of armature plate and magnet is required to ensure proper function of sensor. Status is indicated locally via an LED mounted on the bottom of the lock housing.

The Security Condition Sensor is available as a factory ordered option only.

### TS – Tamper Switch

This is a single pole double throw switch to monitor proper wiring cover closure. Opening wiring cover changes state of the switch which can trigger a remote alarm.

The Tamper Switch is available as a factory ordered option or separately as a field installed accessory.

### DP – Standard Door Position Sensor

The DP feature monitors the position of the door upon which the lock is installed. A SPDT reed switch mounted within the lock cavity eliminates the need for extra sensors to be installed on the door for notification of security or access control systems. The EML310 and EML320 come with a magnet pre-installed into the lock armature plate for signaling the reed switch in the housing when the door is closed. Care should be taken during the final testing of the lock to ensure that the DP feature is operating in the desired manner.

# EML310 & EML320 Electromagnetic Lock Installation Instructions (Continued)

## Listings

These products have been successfully tested and evaluated by UL in two separate categories for use in both the United States and Canada.

Auxiliary Lock. The GWXT fire listing qualifies these for use with UL Classified fire doors maximum 4' in width and 8' in height. Rated up to and including 1 hr.



Component for use in Special Locking Arrangements. Additionally, these products are qualified components for the purpose of locking outward-swinging exit doors against unauthorized egress. They are designed to release automatically in case of a power failure or upon activation of an automatic fire alarm system wired to the power supply fire panel relay.



### The Following Conditions of Acceptability Apply:

1) This product is intended for use with Special Locking Arrangements which are installed in accordance with the manufacturer's installation and operation instructions, the Life Safety Code, NFPA 101 of the National Fire Protection Association and the local authority having jurisdiction.

2) The power for this unit is to be provided by a Listed (ALVY, ALVY7, FULA, FULA7, FUPPC, UEHX7, APHV or APHV7) Class 2 power supply when designated as a Special Locking Arrangement (FWAX or FWAX7).

3) The suitability of the lead wires is to be evaluated per the requirements for the end-use product.

4) When this product is installed in conjunction with a fire alarm control panel, the wiring from the control unit to this product device shall be for fail-safe operation.

5) For Canadian Installations, this product is to be installed in accordance with the manufacturer's installation and operation instructions, The Canadian Electrical Code C22.1-02, and the local authority having jurisdiction.

6) To qualify for use in a delayed-egress locking system, the reload delay must be set to 0 seconds.

UL testing was conducted on standard model without accessories. These locks are not intended or tested for use as a UL Listed Burglar Alarm System Unit.

These models have also been independently tested to the ANSI/BHMA A156.23-2010 American National Standard for Electromechanical Locks.



**Holding Force:** 1500lbf

**Cycle Test:** Grade 1 = 1 million cycles

## Specifications

**MECHANICAL** (Including 1/4" [6.4mm] mounting bracket):

EML310 Lock Dimensions:  
1-5/8"D x 2-7/8"W x 10-1/2"L (41mm x 73mm x 268mm)

EML320 Lock Dimensions:  
1-5/8"D x 2-7/8"W x 21"L (41mm x 73mm x 533mm)

Standard DP Armature Plate Dimensions:  
5/8"D x 2-3/8"W x 10"L (16.5mm x 61mm x 254mm)

**ENVIRONMENTAL:** Not for use in outdoor environments.  
Circuit board operating temperature: 14 to 140°F (-10 to 60°C)

### ELECTRICAL:

**Voltage:** Auto sensing 12VDC or 24VDC

**Current:** 0.65A at 12VDC  
0.45A at 24VDC

**NOTE:** The EML320 lock contains 2 control boards that will each draw 0.65A at 12VDC and 0.45A at 24VDC

**BA Output Relay\*:** SPDT relay. Contacts rated at 1.25A at 24VDC

**DP Reed Switch\*:** Magnetically actuated SPDT switch. Contacts rated for 0.20A at 12VDC and 0.12A at 24VDC

**TS Tamper Switch\*:** SPDT switch. Contacts rated at 3A at 24VDC

\* Effective for either resistive or inductive loads  
(power factor ≥ 0.6 with inductive loads)

**NOTE:** Specifications may change without notice.

Power Supply:

Voltage	EML310	EML320
12VDC	0.65A	0.65A x 2 = 1.30A
24VDC	0.45A	0.45A x 2 = 0.90A

**NOTE:** All Dorma electromagnetic locks must be powered with a Listed filtered and regulated DC power supplies such as the Dorma PS Series UL Listed power supply. Dorma offers a full line of power supplies and switching devices that are suitable for use with the EML310 and EML320 locks.

# EML310 & EML320 Electromagnetic Lock Installation Instructions (Continued)

## Inspection and Maintenance

This product and all related accessories or parts must be inspected and maintained on a **quarterly basis**. Contacting surfaces of the electromagnetic lock and armature plate must be kept free of contaminating materials. Surfaces must be cleaned periodically with a non-abrasive cleaner.

All mounting fasteners must be inspected on a **quarterly basis**. When properly installed, the ends of the armature plate allow a slight movement but the plate will feel secure when grasped at the bolt. There should be no movement to the mounting bracket or housing of the electromagnetic lock.

For added safety, thread locking compound has been provided for the armature plate bolt and the four captive electromagnetic lock mounting screws.

**WARNING: Improper installation, maintenance, inspection or usage of the product or any related accessories or parts may cause the electromagnetic lock, armature plate and associated hardware to disengage and fall, causing serious bodily injury and property damage.**

PLEASE DELIVER ALL INSTALLATION INSTRUCTIONS TO THE END-USER UPON COMPLETION OF THE INSTALLATION.

**For product support, parts and ordering information contact:**

**DORMA**  
**Dorma Drive, Drawer AC**  
**Reamstown, PA 17567 USA**

**Phone: (717) 336-3881**

**Fax: (717) 336-2106**

**Toll Free: (800) 523-8483**

**Email: archdw@dorma-usa.com**

## EML310 - EML320 Series Troubleshooting Guide

Problem	Solution
Cannot remove the lock mounting bracket from top of magnet for installation.	Remove anti-tamper screw and cavity screw. Insert supplied Allen wrench into mounting bolt holes in the bottom of the lock housing and turn. (See Fig. 2)
Lock is installed but has no holding force at all.	Check connections at power supply, connected releasing devices, lock terminals and lock circuit board to magnet core. Check delayed relock wiring and time setting. Check that the momentary switch does not include a shunted light option.
Lock has enough holding force to lightly hold a screwdriver or set of pliers but door will not lock.	Check to see that armature plate is correctly aligned with the electromagnetic lock. If there is improper alignment, make a 1/4" turn of the armature plate mounting bolt and check for alignment. <b>CAUTION:</b> The armature plate must remain affixed securely to the door or serious bodily injury or property damage may occur. Bolt should be tight enough to hold the armature plate to the door while still allowing for alignment with the electromagnetic lock.
Lock is operating and locking but the armature plate is "humming" against the surface of the lock.	This generally indicates that the lock is either operating on AC voltage or there is some AC voltage present in the DC supply. A properly filtered and regulated DC power supply is required to achieve optimal operation from the lock.
Lock is not releasing immediately upon removal of power.	Ensure that switching devices are interrupting the DC power and not the AC power supply voltage. Ensure rubber washer on armature plate mounting bolt has not been removed or damaged. Check that switching device interrupts the positive wire and not the negative wire (See Fig. 3). Remove any Diodes or other suppression devices that may be installed.

# EML310 & EML320 Electromagnetic Lock Installation Instructions (Continued)

## Product Accessories Guide Accessories may impact holding force. (Separate installation instructions provided with accessories.)

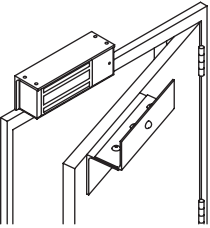
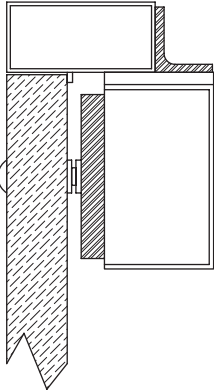
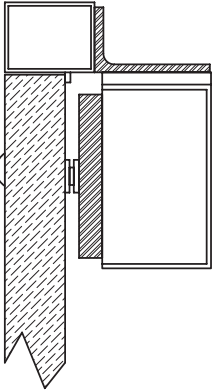
Part	Usage	Example
<p>Top Jamb Bracket (TJ)</p>	<p>Top Jamb bracket and angle bracket kit is required for use when mounting the lock on a door that swings inwards. Magnet mounts to the underside of an angle bracket mounted on the frame. Armature plate mounts to "Z" bracket assembly mounted to door face.</p>	
<p>Angle Bracket (AB)</p>	<p>Used in a narrow head jamb situation or for center-hung doors. Any place where there is insufficient frame depth to mount the lock.</p> <p>Available in several different sizes and finishes.</p>	
<p>"L" Bracket (LB)</p>	<p>Required wherever there is insufficient space on the frame header to mount the lock. The lock mounts to the underside of the "L" bracket and the "L" bracket then gets mounted to the doorframe.</p> <p>Available in several different sizes and finishes.</p>	

# EML310 & EML320 Electromagnetic Lock Installation Instructions (Continued)

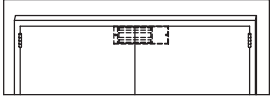
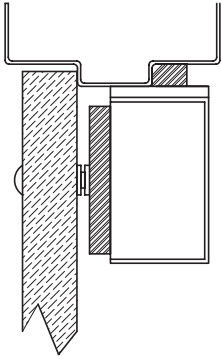
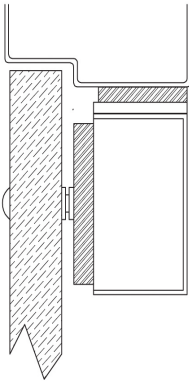
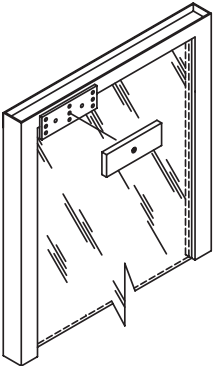
Part	Usage	Example
<p>Split Armature Plates (SAP)</p>	<p>Used for traffic control applications where two doors are to be used with a single lock. The Split Armature plates are half the length of a standard armature. Each of these is mounted on one of a pair of doors with an lock centered on the frame between the doors.</p> <p><b>NOTE:</b> Use of split armature plates will reduce holding force.</p>	
<p>Filler Bars (FB)</p>	<p>Used to provide extra mounting space in a hollow metal or wood frame where the door stop of the frame is not thick enough to allow a lock to be installed.</p> <p>Available in several different heights and widths.</p>	
<p>Spacer Bars (SB)</p>	<p>For use when an obstruction in the door prevents the installation of the armature plate at a proper height. If the armature plate needs to be lowered then a spacer bar can be used to lower the lock from the frame.</p> <p>Available in several different heights.</p>	
<p>Armature Plate Holder (APH)</p>	<p>For use with doors that do not permit the armature plate to be mounted low enough to meet the magnet surface. The armature holder can be mounted to whatever frame is available and the armature plate in turn mounted to the holder.</p> <p>Available in both flat (shown) and pocket styles.</p>	

# EML310 & EML320 Electromagnetic Lock Installation Instructions (Continued)

## Wire Gauge Selections

Total One Way Length of Wire Run (ft.)	Load Current @24V							
	1/4A	1/2A	3/4A	1A	1-1/4A	1-1/2A	2A	3A
100	20	18	16	16	14	14	12	10
150	20	16	14	14	12	12	10	--
200	18	16	14	12	12	10	10	--
250	18	14	12	12	10	10	--	--
300	16	14	12	10	10	--	--	--
400	16	12	10	10	--	--	--	--
500	14	12	10	--	--	--	--	--
750	12	--	--	--	--	--	--	--
1000	12	--	--	--	--	--	--	--

Total One Way Length of Wire Run (ft.)	Load Current @12V					
	1/4A	1/2A	3/4A	1A	1-1/4A	1-1/2A
100	18	16	14	12	12	10
150	16	14	12	10	10	--
200	16	12	10	10	--	--
250	14	12	10	--	--	--
300	14	10	--	--	--	--
400	12	10	--	--	--	--
500	12	--	--	--	--	--
750	10	--	--	--	--	--

These recommended wire gauge selection tables are based on the 2008 National Electrical Code (2008 NEC), assume 60°C (140°F) rated wire, include a 25% safety factor, and define the amperage ratings at the listed distances that result in 5% voltage drop due to wire resistance. Five percent is normally acceptable in low voltage systems.