

WN 056460 45532  
11/11

Art. Nr. 13000100

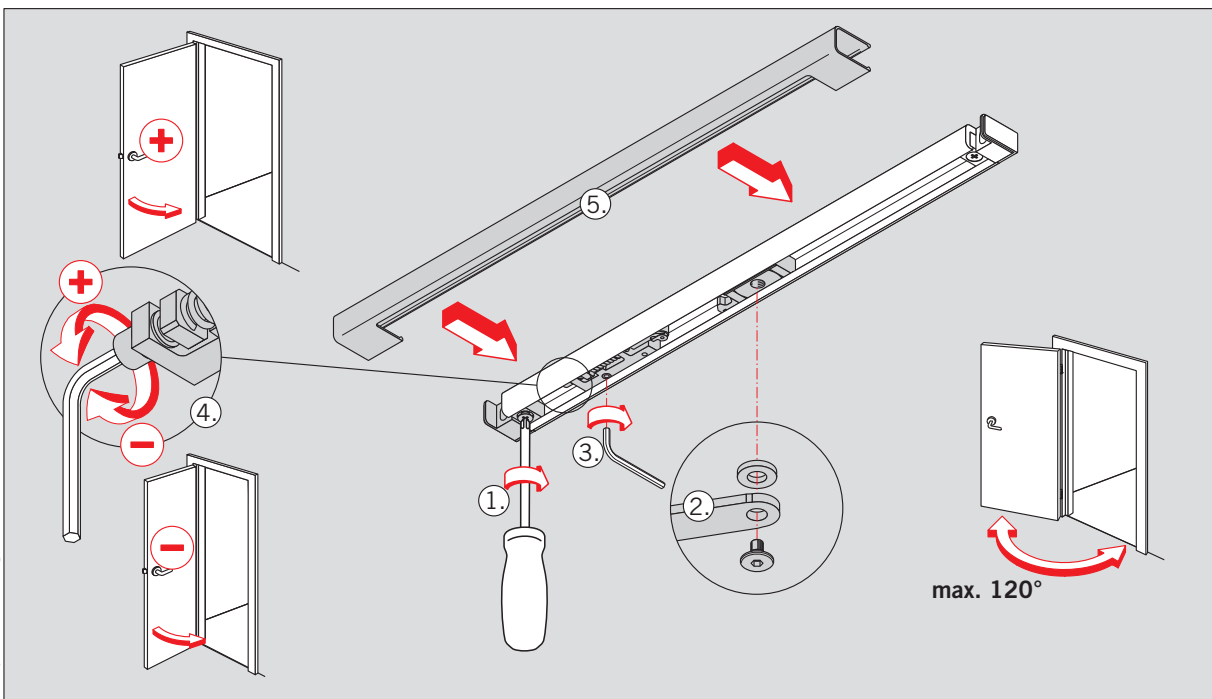
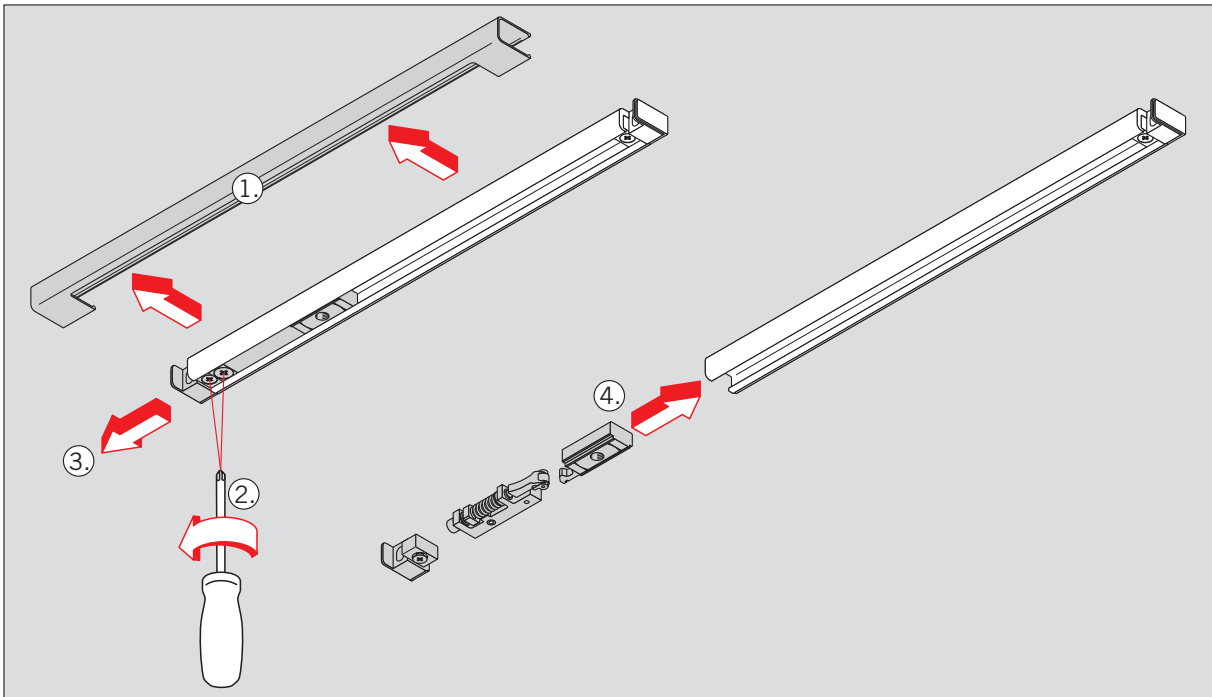
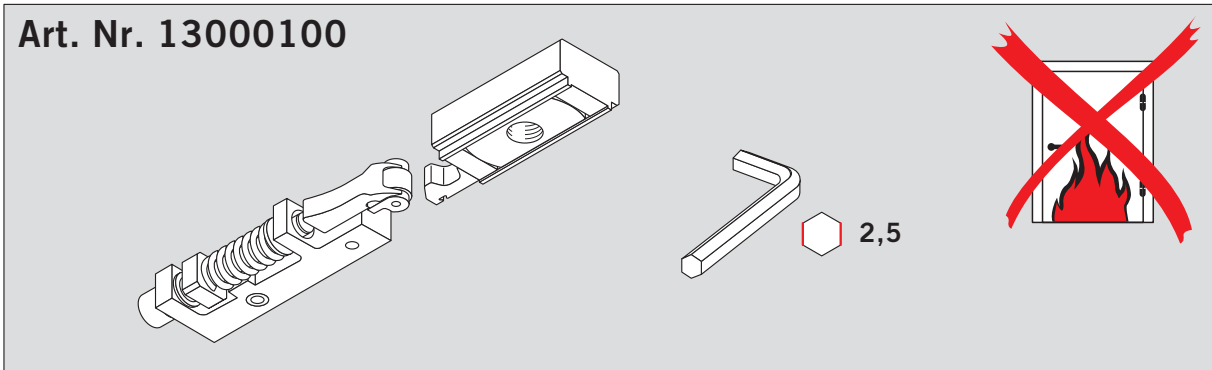

Änderungen vorbehalten  
Subject to change without notice