



Electronic safe lock

Axessor IP

Technical Manual

V28 - 08/2019

EN

dormakaba 

dormakaba Schweiz AG
Mühleühlstrasse 23
8620 Wetzikon
Switzerland
T: +41 (0)44 931 61 11

www.dormakaba.com

Copyright © dormakaba 2019
All rights reserved.

No part of this document may be reproduced or used in any form or by any means without prior written permission of dormakaba Schweiz AG.

All names and logos of third-party products and services are the property of their respective owners.

Subject to technical changes.

Version notes

Document version	Date	Reason
02	2019-08	New functionalities included
01	2018-03	New functionalities included
00	2017-10	New document created

Firmware version	Date	Reason
V28	2019-08	<p>New functionalities and optimizations:</p> <ul style="list-style-type: none"> Setting up Axessor CONNECT safe lock systems with up to 10 locks, 2 input units and 1 eBox Extended functionality of the safe locks: the Device Manager being able to manage safe lock systems Operating the safe lock system via the input unit or via AS284-USBW / NETW Motorized latchbolt locks Worldwide DST function GUI texts of AS280-INSW and AS284-USBW / NETW and audit added and revised Several issues of AS284-USBW / NETW added and revised
V27	2018-03	<p>New functionalities and optimizations:</p> <ul style="list-style-type: none"> Keep arrow keys pressed while automatically changing the adjusting value to a higher or lower value Changing or creating codes without using a workaround Setting the time in AM/PM without using a workaround Texts revised in GUI of AS280-INSW and AS284-USBW/NETW and audit Several issues revised of AS284-USBW/NETW
V26	2017-10	<p>New functionalities and optimizations:</p> <ul style="list-style-type: none"> Partial Locking in Bank Mode with activated Dual Mode Adjustable maximum value of time locking periods while activating the Immediate Time Lock Local language selection in the menu "info" Stabilized "Line off" behavior No special characters in the audit function

Firmware version	Date	Reason
		<ul style="list-style-type: none"> Operating system compatibility of AS284-W programming software AS284-W programming software with extended function
V24	2017-06	<p>New functionality:</p> <ul style="list-style-type: none"> The Master Code can override the Immediate Time Lock
V23	2017-02	<p>New functionalities:</p> <ul style="list-style-type: none"> Special function: User Code 41 configured as Audit and Battery Code Special function: User Codes 45 and 46 used for activation of the output impulse signal Special function: User Code 47 configured as Time, Audit and Battery Code Special function: User Code 48 used for Lock Disabling and User Code 49 used for Lock Enabling Immediate Time Lock when the safe is closed Setting the beeper via input unit Selection of days for time-related functions Door Open Alarm is separately configurable Dual Mode timeout is configurable

Table of Contents

	Glossary	7
1	About this document	9
1.1	Purpose and objective	9
1.2	Target group	9
1.3	Compliance with safety and standards	9
2	Safety information	10
2.1	Intended use	10
2.2	Hazard category	10
3	Norms, standards and regulations	11
4	Certificates	12
5	System overview	13
6	System description	16
6.1	The Axessor IP electronic safe locks	16
6.2	Product variants	16
6.2.1	Standalone variant with a single lock	16
6.2.2	Standalone variant with multiple locks	17
6.2.3	Network variant with a single lock and an optional eBox	18
6.2.4	Network variant with multiple locks and an optional eBox	19
7	Software applications	21
8	Scope of application	22
9	Technical data	23
9.1	Hardware	23
9.2	Interfaces	23
9.3	Mechanical components	24
9.4	Conditions	24
10	Factory settings	25
11	Functionality	29
11.1	Display elements of the input unit	29
11.2	Information menu	29
11.3	Immediate Time Lock	29
11.4	Time-Related Functions	30
11.5	Time-Related Functions with deactivated Partial Locking	31
11.6	Time-Related Functions with activated Partial Locking	31
11.7	Beep signals	32
11.8	Status messages	33
11.8.1	Bank Mode and One Time Mode	33
11.9	Access codes	37
11.9.1	Code hierarchy and code formats	37
11.9.2	Code types	38
11.9.3	Master Code	39
11.9.4	Manager Codes	40
11.9.5	User Codes with special functions	41
11.9.6	Courier Code	42
11.9.7	Duress Code	42

11.9.8	Shelve Function	43
12	Access rights	44
13	Unpacking and checking delivery	53
13.1	Checks before installation	53
14	Installation	54
14.1	Drilling templates	54
14.2	Installing the input unit	56
14.3	Installing the lock	62
14.4	External connections on the lock	64
14.5	Installing the eBox	66
14.6	External connections on the eBox	67
14.7	eBox wiring diagram	68
14.8	Wiring	68
14.8.1	Cold plugging	69
14.8.2	Hot plugging	70
14.8.3	Wiring options	72
14.9	Wiring check of the lock	72
14.10	Wiring check of the eBox	73
15	Configuration	74
15.1	Programming Mode	74
15.1.1	Menu overview of the master lock	74
15.1.2	Accessing the Programming Mode	75
15.1.3	Navigating in Programming Mode	76
15.1.4	Changing and saving settings	76
15.1.5	Exiting the Programming Mode	76
15.1.6	Menu TIME	77
15.1.7	Menu PROG	78
15.1.8	Menu DELAY	85
15.1.9	Menu CODE	89
15.1.10	Menu MISC	93
16	Operation	105
16.1	Code entry	105
16.2	Lock opening procedure	105
16.3	Lock closing procedure	107
17	Troubleshooting	108
17.1	Status messages on LCD	108
17.2	Identification of the lowest serial number	110
18	Service	111
18.1	Cleaning	111
18.2	Replacing batteries	111
19	Maintenance	113
19.1	Replacing a defect lock	113
19.1.1	Removing the defect lock from the safe lock system	113
19.2	Adding a new lock to the safe lock system	114
19.2.1	Adding a new lock with Freeze OFF	114
19.2.2	Adding a new lock with Freeze ON	115
19.3	Removing the error message of lock position -16-	116
20	Disposal	118
21	Spare parts and accessories	119

Glossary

Terms	Meaning
A-CIT 28	Axessor CIT, version 28
A-IP 28	Axessor IP, version 28
A-IP N 28	Axessor IP NOT version 28
AS280-INSW	AS280 Installation Software and Wibu dongle
AS284-NETW	AS284 Network Solutions and Wibu dongle (programming software)
AS284-USBW	AS284 Universal Serial Bus and Wibu dongle (programming software)
ATM	Automated Teller Machine
A-USB	Axessor USB, version 28
BAT-CMP	Battery Compartment
BLT OPN	Bolt Open Time
CDE DEN	Code Denial
CNF WIN	Confirmation Window
CNF WIN beep	Confirmation Window beep
CONF	Confirmation
D-ALARM	Door Alarm
DEL key	Key used to delete entry or to close the lock.
DEL key	Key used to delete entry or to close the lock.
DEVICE	Device Manager used to manage the safe lock system.
DM	Dual Mode
DST	Daylight Saving Time
ENTER key	Key used to enter codes or to confirm parameterization.
GDPR	General Data Protection and Regulation
IMM-TL	Immediate Time Lock
INFO/ESC key	Key used to activate the info display, to escape or to go to a higher level.
LAN	Local Area Network
LANG	Language
LCD	Liquid Crystal Display
LED	Light-Emitting Diode
LEFT and RIGHT keys	Keys used to select and adjust settings.
MISC	Miscellaneous
MOT FLT	Motion Fault
NRTD	Non-Return Time Delay
NRTD HM	Non-Return Time Delay in Hours/Minutes
ONE SC4 bank	One Shot Codes for Bank Mode
PRG-MOD	Programming Mode
RMT-DIS	Remote Disabling

Terms	Meaning
SM	Single Mode
TL-INT	Time Locking Interruption
TR-FCN 1 ... 3	Time-Related Function 1 ... 3
TST END	Test end The wiring test is finished.
0 ... 9	Numeric keys 0 ... 9

1 About this document

1.1 Purpose and objective

This Technical Manual describes the Axessor IP electronic safe locks with network capabilities.

It gives information on:

- The system and components
- Technical data
- Functionality
- Installation
- Configuration
- Operation
- Troubleshooting
- Service
- Maintenance
- Spare parts and accessories.

1.2 Target group

This document exclusively addresses itself to skilled personnel (technicians) trained and authorized by the manufacturer.

1.3 Compliance with safety and standards

For safety and warranty reasons all actions described in this document must only be carried out by skilled personnel (technicians). Skilled personnel must comply with the respective regulations on work safety and prevention of accidents.

2 Safety information

2.1 Intended use

The purpose of the electronic safe lock is to lock and unlock the mechanical blocking point of a safe, vault, data cabinet or ATM which is usually activated manually by bolt work. Do not modify the electronic safe lock since it will impair the security and safety of the unit. The electronic safe lock is only designed for indoor applications. It must be applied in environmentally protected areas.

2.2 Hazard category

NOTICE

Information on how to handle the product correctly.

Failure to observe this information may result in malfunctions. The device or something in its vicinity could be damaged.

3 Norms, standards and regulations

Europe

Name	Title
EMC	Directive 2014/30/EU Electromagnetic compatibility
EN 1300:2013	Classification for high-security locks according to their resistance to unauthorized opening
RoHS 2	Directive 2011/65/EU Restriction of hazardous substances
GDPR	Regulation EU 2016/679 General Data Protection Regulation

America

Name	Description
UL Subject 2058 Outline of investigation of high-security electronic locks	High-security electronic locks, type 1 - model Axessor IP and IP NOT, consisting of keypad P/N 3310300316, and lock assembly P/N 3582706300

4 Certificates

Europe

Name	Description
ECB-S	Electronic high-security lock, level B
CNPP A2P	Electronic high-security lock, level B

5 System overview

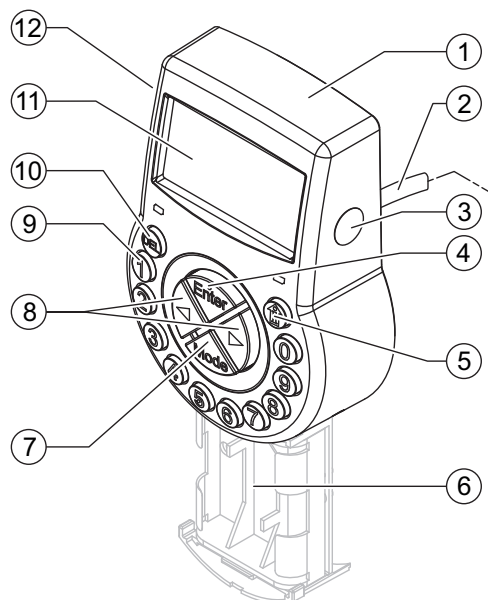
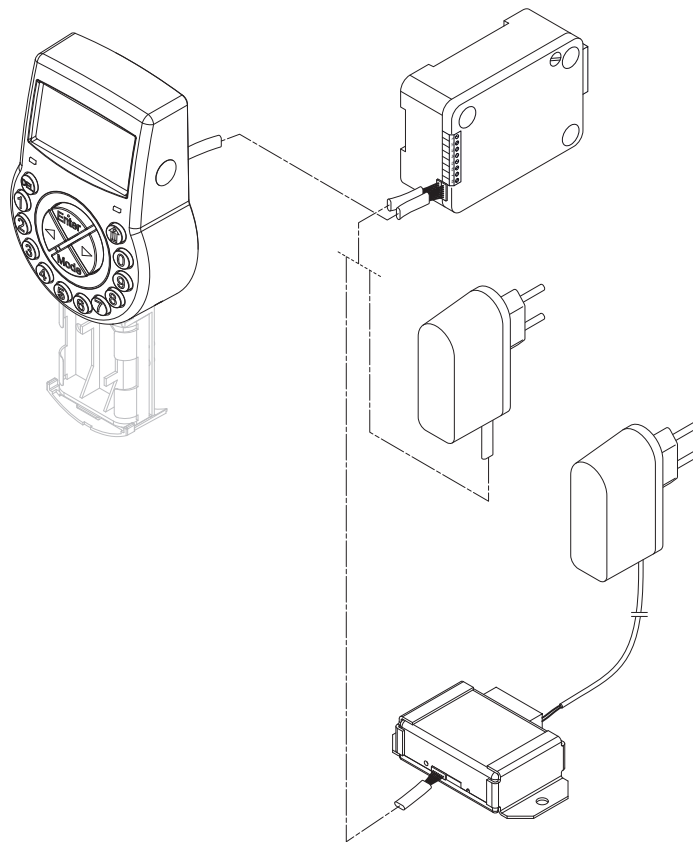

Input unit

- | | | | |
|---|-----------------------------------|----|---------------------------|
| 1 | Housing | 7 | MODE key |
| 2 | Connecting cable for lock unit | 8 | LEFT/RIGHT key |
| 3 | Interface (USB) for PC connection | 9 | NUMERIC keys 0...9 |
| 4 | ENTER key | 10 | DEL key |
| 5 | INFO/ESC key | 11 | LCD |
| 6 | Battery compartment | 12 | Beeper |

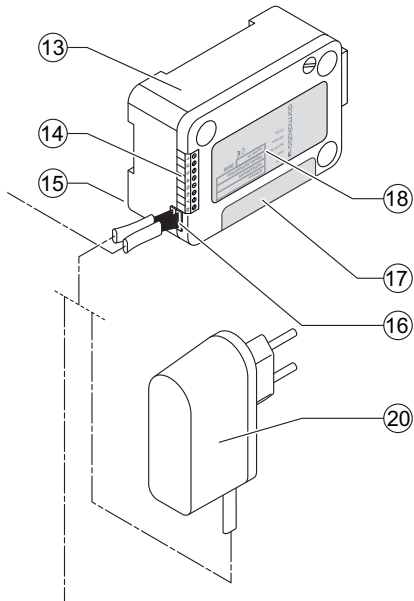

Lock and optional external power supply

13	Lock housing	17	Warranty seal
14	Inputs/outputs	18	Type label
15	Pin for cable tie	19	
16	Connection sockets X1 and X2	20	External power supply (optional), 6 VDC, 2 A

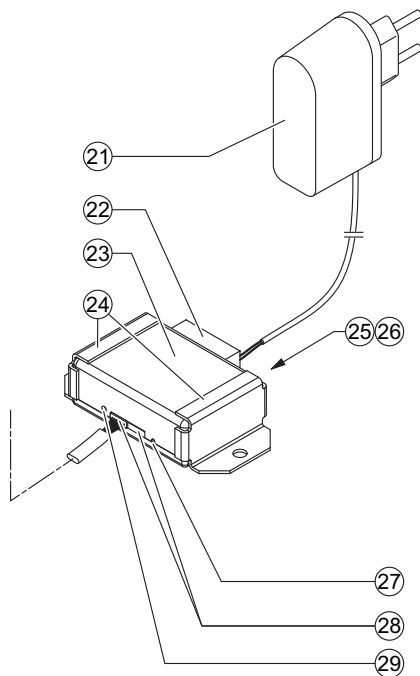

Optional eBox and power supply

21	Power supply, 12 VDC, 1 A	26	RJ45 socket
22	Connector	27	Reset opening
23	eBox	28	Connection socket
24	Fixation supports	29	LED for eBox status

25 LEDs for network status

6 System description

6.1 The Axessor IP electronic safe locks

The Axessor IP with network capabilities are motorized deadbolt and latchbolt locks with standard dimensions and integrated terminals. It is possible to connect the safe locks to an alarm center. The locks comply with all relevant safety standards.

The electronic safe locks have the following functions:

- Single and multiple safe lock applications
- Code hierarchy with user group management
- Courier Code
- Dual Mode
- Duress Code
- Time Delay
- Time Locking Function
- Remote Enabling and Disabling
- Code Denial for user

There are 2 options to configure the safe locks:

- Via input unit
- Via AS284-USBW programming software installed on a computer which is connected to the input unit via a USB cable

Requirements:

When working with AS284-USBW or AS284-NETW programming software, make sure to comply with minimum requirements for the computer and monitor.

- Operating system of the computer: Windows 7 or higher
- Minimum resolution of the monitor: 1280x1024 pixel

6.2 Product variants

6.2.1 Standalone variant with a single lock

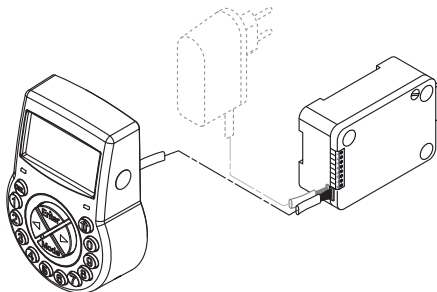

The standalone variant is battery-powered consisting of:

- Input unit
- Lock
- Connecting cable

The lock provides:

- 2 inputs
- 2 outputs

A further option is to connect an external power supply (6V DC/500mA) to the connection sockets X1 or X2.

Requirements:

- Only use the original Axessor power supply, 6 VDC, 2 A.
- Only use non-rechargeable AA alkaline or AA lithium batteries.
- Batteries must always remain in the battery compartment, even if the external power supply is connected as they serve as energy source in case of power failure.

6.2.2 Standalone variant with multiple locks

NOTICE

Battery discharge and heating up

Operating a safe lock system with 2 input units being powered with batteries will cause a battery discharge due to potential equalization.

The battery discharge is faster than in normal conditions and requires an earlier replacement of batteries.

Batteries can heat up due to potential equalization.

- Only put batteries in the battery compartment of 1 input unit of a safe lock system.
- Use external power supplies for a safe lock system to support the batteries of the single equipped input unit with additional energy.



Not more than 10 locks to be connected in a safe lock system.
 Not more than 4 bolts to be moved at a time. There is a high risk that a motion fault can be caused.

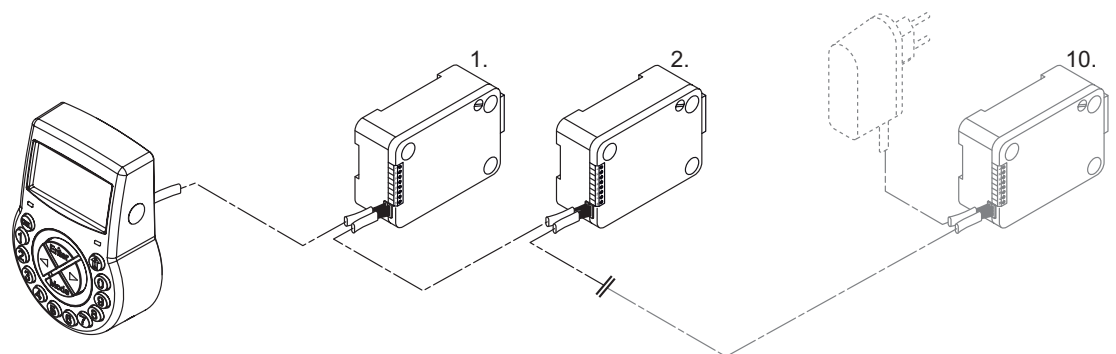

It is highly recommended to place the additional external power supply in the last position of the safe lock system. In that way the units will be powered from both sides of the Axessor bus.

The standalone variant with multiple locks is battery powered consisting of:

- Up to 2 input units
- Up to 10 locks
- Connecting cables

The locks provide:

- 2 inputs
- 2 outputs

The maximum length of the Axessor bus is 30 meters.

6.2.3 Network variant with a single lock and an optional eBox

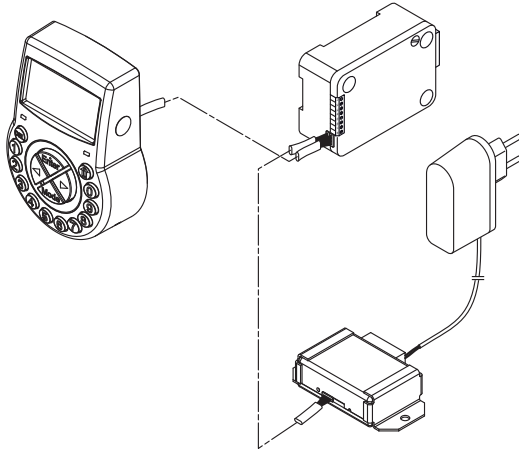

The number of different components required depends on:

- The size of the system
- The number of locks
- and the number of operators using the management software.

Network integration of the electronic safe lock is realized via the optional eBox. The eBox consists of 5 freely configurable inputs and 5 outputs of which only 4 outputs are freely configurable. Output 7 is fix set for "no external power" and it cannot be defined for another use. Inputs/outputs and an external power supply (9 ... 26V DC/700 ... 200mA) are connected via the eBox connector. An external power supply, 12 VDC, 1 A is required for the eBox functions (network connection and inputs/outputs).



In case of power failure the batteries only supply lock functions.

The following software is required to set up and configure the electronic safe lock:

- AS280-INSW for network integration and OTM activation
- AS284-USBW or AS284-NETW programming software

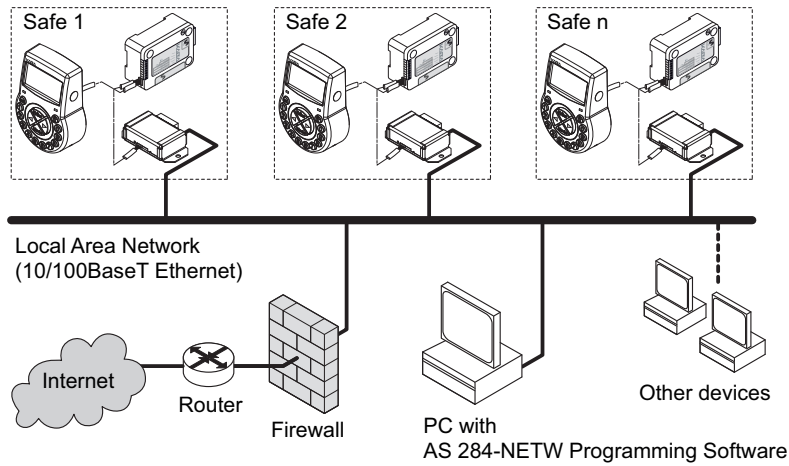

6.2.4 Network variant with multiple locks and an optional eBox

NOTICE

Battery discharge and heating up

Operating a safe lock system with 2 input units being powered with batteries will cause a battery discharge due to potential equalization.

The battery discharge is faster than in normal conditions and requires an earlier replacement of batteries.

Batteries can heat up due to potential equalization.

- Only put batteries in the battery compartment of 1 input unit of a safe lock system.
- Use external power supplies for a safe lock system to support the batteries of the single equipped input unit with additional energy.



Not more than 10 locks to be connected in a safe lock system.

Not more than 4 bolts to be moved at a time. There is a high risk that a motion fault can be caused.

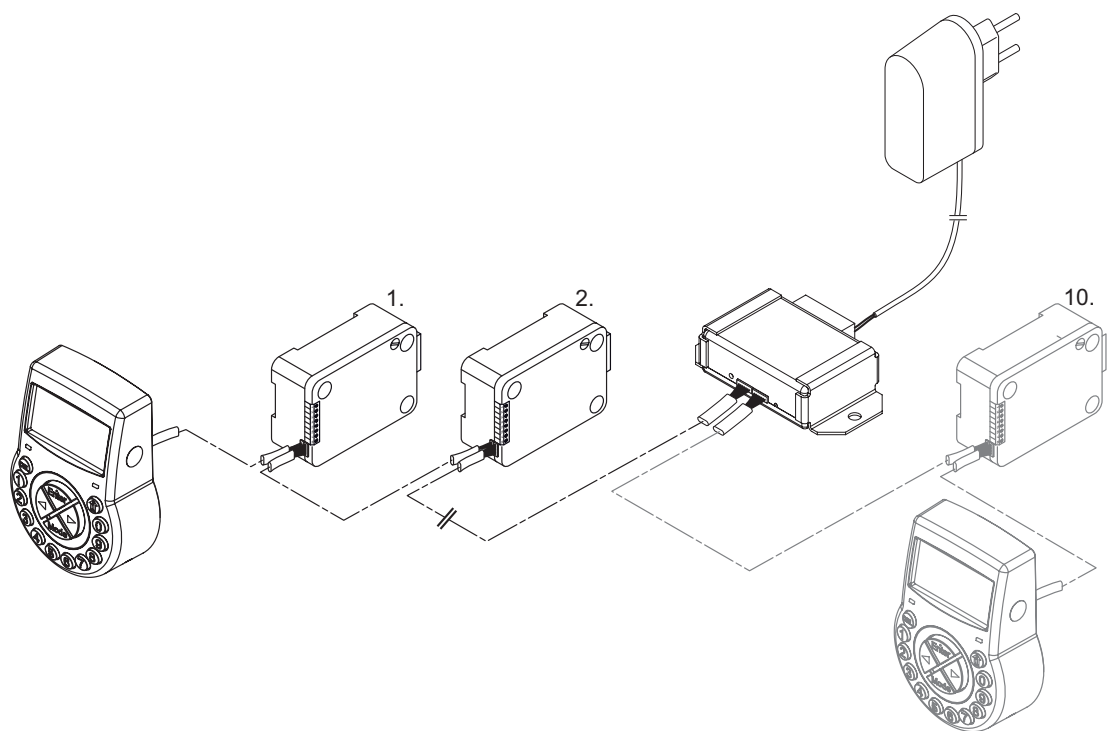

The connection between AS284-USBW or AS284-NETW programming software and the locking system will be established with lock -1- (master lock) either via network or USB interface. The established connection will be used from all slave locks. The locks are clearly identified and administered by their serial number and their system address. The master lock assigns the system addresses to the slave locks and manages the lock info.



Changes in lock lists can lead to data loss of lock lists or communication errors.

It is highly recommended to newly set up the master lock via AS280 -INSW installation software after each change of the lock info and to replace the master lock in AS284-USBW or AS284-NETW programming software.

The IP settings for the connection of the locking system will be loaded by the master lock. The slave locks (lock 2-x) only have inactive IP settings. The remote access for the slave locks is only possible if the IP settings have been saved in the master lock and the installation file.

Requirements:

- For eBox usage, the master lock must be either an IP or CIT lock.
- The installation comment in the IP settings must be written with AS280-INSW installation software for the remote access of all IP locks (2-x) of a locking system. Locks with activated remote access are marked with "IP" in the lock list in AS280-INSW installation software and AS284-USBW or NETW programming software.



IP locks must be newly installed via AS280-INSW installation software after replacing a lock or changing the wiring or moving locks.

The IP settings must be written newly in the lock and the installation file. The safe lock systems must be deleted from the locks file in AS284-USBW or NETW programming software. The installation file must be newly imported.



It is possible to configure and change all functions and codes of an activated safe lock system with IP, IP NOT and CIT locks when the locks are closed. USB locks are not supported in a network.

7 Software applications



The AS280 and AS284 software products were not evaluated by UL 2058 and are only for supplementary use.



Do not use third party USB hubs.

AS280-INSW Installation Software for the Windows® operating system is applied for network installation.

AS284-USBW or **AS284-NETW** programming software for the Windows® operating system is applied to configure basic settings of the lock such as language, opening time delay, inputs and outputs.

8 Scope of application



When using software products, personal data can be recorded and processed.

The provision of art. 6 (1) lit b from EU 2016/679 General Data Protection Regulation (GDPR) shall be applicable if processing of personal data aims to the fulfillment of a contractual or pre-contractual obligation

The electronic safe locks have the following functions for applications in the high security sector:

- Configuring codes and code combinations
- Time functions
- Recall of a detailed event log (audit trail)
- One Time Code operation (optional).

The electronic safe locks are suitable and applicable for:

- Single and multiple safe lock applications
- Multiple users
- Traceability
- Flexibility.

9 Technical data

9.1 Hardware

Hardware type	Hardware property	Description
Power supply	3 alkaline AA batteries 1.5 V - LR6 or 3 lithium AA batteries 1.5 V - FR6	Service life of alkaline batteries: approximately 1-2 years with 1 opening/closing cycle per work day Service life of lithium batteries: approximately twice as long as alkaline batteries
Memory	Non-volatile	Memory is protected against power failure.
Display	Iconographic LCD with high contrast	Display language is selectable by the user (German, English, French, Italian, Spanish, Portuguese, Dutch, Polish, Hungarian and Turkish).
Keypad	Silicone keys (10 numeric, 4 function, 2 navigation keys).	

9.2 Interfaces

Interface type	Interface property	Description
Outputs	2 potential-free contacts for alarm (30VDC/2A, 50VAC/0.5A with resistive load) Output 1: Duress Alarm (factory setting) Output 2: Bolt or motor open (factory setting)	It is possible to configure the outputs via AS284-USBW or AS284-NETW programming software for the following functions: <ul style="list-style-type: none"> • Lock open • Door Open Alarm • Activated Time Delay • Activated penalty time • Entry of Duress Code • Battery compartment open
Inputs	Input 1 (signal-triggered 12VDC min. 13mA, max. 20mA): not configured (factory setting) Input 2 (contact triggered; potential-free contact only) Do not apply any voltage.	It is possible to configure the inputs via AS284-USBW or AS284-NETW programming software for the following functions: <ul style="list-style-type: none"> • Remote Enabling and Disabling • Door contact, • Interruption of Time Delay - override NRTD
USB	USB for data exchange with a computer	Connection to a computer for the configuration with AS284-USBW or AS284-NETW programming software
Axessor bus	For connection of the input unit, lock, external power supply or eBox	dormakaba proprietary bus system

Interface type	Interface property	Description
	Max. length is 30 meters	

9.3 Mechanical components

Lock	Component property
Dimensions	85 x 61 x 33 mm
Weight	495 g
Motor bolt	Dead bolt or optionally a spring bolt
Relocker	Integrated lock relocker
Cycle times	Opening/closing: approximately 2 seconds
Static resistance force	Maximum: 1000 N in all directions (in end positions)
Moving force	Maximum: 5 N in both directions
Service life	50 000 cycles
PCB designation	A21-P-01-05_L

Input unit	Component property
Dimensions	128 (193) x 90 x 40 mm
Weight	660 g (including connecting cable and batteries)
PCB designation	A08-P-03-04

eBox (optional)	Component property
Dimensions	78 x 51 x 26 mm
Weight	maximum 160 g
System of protection	IP53

9.4 Conditions

During operation	Temperature range
Lock	0 ... +50°C
Input unit	0 ... +50°C
eBox	0 ... +50°C

Storage	Temperature range
Lock	-10 ... +60°C
Input unit	-10 ... +60°C
eBox	-40 ... +70°C

Humidity	Humidity range
eBox, lock and input unit	28% - 90% relative humidity, non-condensing

10 Factory settings

It is possible to select the following display languages:

- English
- French
- German
- Dutch
- Italian
- Spanish
- Hungarian
- Polish
- Portuguese
- Turkish

Function	Factory setting	Possible to change with	
		Input unit	AS284-USBW or AS284-NETW (optional)
Display Language and Info Menu Language	English	✓	✓
All languages in the info menu	On	✓	✓
Master Code	0 0 1 2 3 4 5 6	✓	✓
Master Code opens the lock	On	-	✓
Master Code overrides Immediate Time lock (closed state)	On	-	✓
Master Code bypasses Time Lock	Off	-	✓
Manager Codes (maximum 4 codes)	Off	✓	✓
Functions when Manager Codes are activated:		-	✓
Opening the lock	On		
Changing Time Delays	On		
Changing the Confirmation Window	On		
Activating the Immediate Time Lock	On		
User Codes (except for special User Codes)	Off	✓	✓
User Code can activate Immediate Time Lock	Off	-	✓

Function	Factory setting	Possible to change with	
		Input unit	AS284-USBW or AS284-NETW (optional)
User Code 41 as Audit and Battery Code	Off	-	✓
User Code 42 as activation code (including Audit and Battery Code)	Off	-	✓
User Codes 45 and 46 for the activation of the output impulse signal	Off	-	✓
User code 47 as Time Code (including Audit and Battery Code)	Off	-	✓
User Codes 48 and 49 for Lock Disabling/Enabling	Off	-	✓
Courier Code	Off	✓	✓
Functions when Courier Code is activated: Bypassing Time Delay and opening the lock only with Courier Code when in Dual Mode Skipping Time Delay but not able to open the lock	On Off	-	✓
One Shot Codes for user group 4	Off	✓	✓
Beep Signal Volume	High	✓	✓
A Beep Signal every 30 seconds when the lock is open	On	✓	✓
A Beep Signal every 60 seconds while (Duress) Time Delay counts	On	✓	✓
A Beep Signal every 60 seconds while the Confirmation Window counts	On	✓	✓
Beeper for Door Opening Alarm	Off	✓	✓
Number of wrong codes entries before penalty	4	-	-
Penalty for wrong code entries	5 min.	-	-
Code denial: Temporary lockout of Manager Codes and user groups Temporary lockout of single users	Off	✓ -	✓

Function	Factory setting	Possible to change with	
		Input unit	AS284-USBW or AS284-NETW (optional)
Duress Code	Off	✓	✓
Duress Code criterion (last digit)	+/- 1	-	✓
Time-Related Functions for up to 3 user groups, weekdays and Partial?: Time-Related Time Delay Toggle Dual Mode Code Disabling	Off	✓	✓
Dual Mode	Off	✓	✓
Functions when Dual Mode is activated: Any 2 codes 2 codes of the same group 2 codes of different groups 2 Manager Codes for Programming Mode Manager Code cross access User Codes	On Off Off Off Off	-	✓
Time Delay	0 min.	✓	✓
Duress Time Delay (per user group)	1 min.	-	✓
Time Delay and Duress Time Delay	Countdown	-	✓
Non Return Time Delay	0 min.	✓	✓
Bolt open time	6 sec.	✓	✓
Process time	2 min. 30 sec.	✓	✓
Confirmation Window	5 min.	✓	✓
Immediate Time Lock Period	0 min.	✓	✓
Maximum adjustable value of the Immediate Time Lock Period	144 h	-	✓
Opening window for Time Locking interruption	Off	✓	✓

Function	Factory setting	Possible to change with	
		Input unit	AS284-USBW or AS284-NETW (optional)
Weekly Locking Period	Off	✓	✓
Holiday Locking Period	Off	✓	✓
Repeated Holiday Locking Period	Off	✓	✓
Date/time	JAN 01 2017 0:00	✓	✓
Time format (12 or 24 h, AM/PM)	24 hours	✓	✓
Change from summer to winter time (DST) and time zone	On (Central European Time)	✓	✓
Remote Disabling via software	Off	✓	✓
Input 1: One function optionally assignable: 1. Remote Disabling 2. Controlled Disabling 3. Remote Enabling 4. Cancelling NRTD	Off	-	✓
Input 2: One function optionally assignable: 1. Door contact 2. Skipping Time Delay 3. Time Locking Interruption 4. Remote Disabling 5. Controlled Disabling 6. External input event: A - F 7. Remote Enabling 8. Cancelling NRTD	Off	-	✓
Output 1: Duress alarm	On	-	✓
Output 2: Lock opening (OR Boolean operation with lock, motor or door open)	On	-	✓

11 Functionality

11.1 Display elements of the input unit

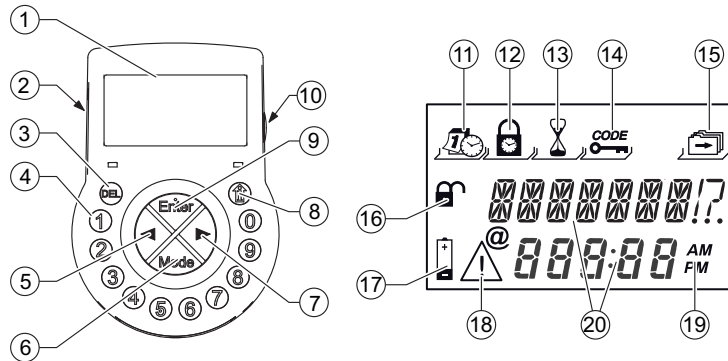

1	LCD	11	Menu TIME
2	Beeper	12	Menu PROG
3	DEL key	13	Menu DELAY
4	NUMERIC keys 0 ... 9	14	Menu CODE
5	LEFT key	15	Menu MISC
6	MODE key	16	Symbol "lock open", "lock closed"
7	RIGHT key	17	Symbol "replace batteries"
8	INFO/ESC key	18	Symbol "warning"
9	ENTER key	19	Time format (12/24 h)
10	USB port	20	Text lines

11.2 Information menu



By pressing the **INFO/ESC** key, it is possible to change the display language in the information menu any time, even if the lock is closed.

By pressing the **INFO/ESC** key the information menu is accessible while the display shows either "OPEN" or "LOCKED".

By pressing several times the **INFO/ESC** key or the arrow keys, it is possible to query the following information in the information menu:

- Display language
- Battery condition (in percent of the nominal capacity)
- Opening counter
- Serial number
- Wait 000:00 (if this setting was chosen).
The numbers 000:00 stand for "hours:minutes".

11.3 Immediate Time Lock

The Immediate Time Lock is a useful function to bridge the time period until a regular locking period of the electronic safe lock starts.

When the lock is closed, it is not possible to open it for the configured time period



The maximum time period is 144 hours.
 Changing hours and minutes to 000:00 will deactivate the Immediate Time Lock.
 By default it is possible for the Master to override the Immediate Time Lock.
 It is possible to deactivate this function via AS284-USBW or AS284-NETW programming software.
 The Immediate Time Lock is not related to time/date.
 It is not possible to bypass the Immediate Time Lock by changing the settings for time/date.

1. If the display is in sleep mode, press any key to wake up the display.
 - ⇒ The lock status appears (for example "locked").
2. Press the **MODE** key.
3. Use the **NUMERIC** keys to enter a valid User Code (for example 12104453).
 - ⇒ For every entered digit an asterisk appears on the display.

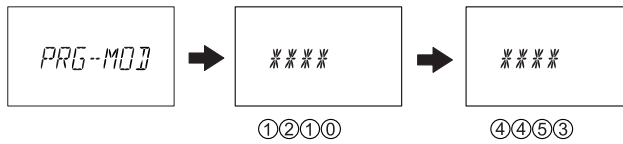

4. Press the **ENTER** key to confirm the code.
 - ⇒ The lock is in Programming Mode for the Immediate Time Lock.
5. Press the **ENTER** key twice .

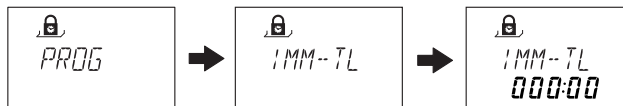

6. Use the **LEFT** or **RIGHT** arrow key to set the duration of time in hours and minutes.
7. Press the **ENTER** key.
8. Select "YES" by using the **LEFT** or **RIGHT** key.
9. Press the **ENTER** key to confirm the settings.
10. Press the **DEL** key twice to exit the menu.

11.4 Time-Related Functions

The Time-Related Functions "Delay", "Toggle Dual Mode" and "Code Disabling" are only operated in Bank Mode.
 The functions are only configurable with Master Code either with the input unit or via AS284-USBW or AS284-NETW programming software.

It is possible to select and configure individual settings (with up to 3 time windows and for any weekly interval) for user groups 1, 2 and 3.
 User group 1 comprises all users of group 1, 1 Manager of group 1 and the Master.

An activated Immediate Time Lock prevents the execution of the Time-Related Functions and all related subfunctions.

Partial Locking is a subfunction of the Time-Related Functions only operated in Bank Mode.
 An activated Partial Locking overrides the set Time-Related functions "Delay", "Toggle Dual Mode" and "Code Disabling" for the selected user groups.

When the lock is opened in Bank Mode after Partial Locking had been reset, the function will be activated again.

The following events reset Partial Locking:

- Immediate Time Locking
- Time Locking (Weekly and Holiday Locking Periods)
- Penalty

- Remote Disabling



Reaching an endpoint of a Time-Related Function does not reset Partial Locking.

The state of the function "Partial Locking" (activated or reset) does not depend on the starting or endpoint of a Time-Related Function.

If the state of the function "Partial Locking" (activated or reset) is set to an output, this output switches on as soon as the lock will be opened.

The output is as long switched on as one of the events (Immediate Time Lock, Time Locking, Penalty and Remote Disabling) will reset Partial Locking.

11.5 Time-Related Functions with deactivated Partial Locking

Time-Related Function "Delay" activated (Bank Mode)

The lock can be opened outside of defined time windows (start and end time) and depending on how the lock was configured. The defined Time Delay (menu "Time-Related Time Delays") is not valid for these configurations.

When entering a valid opening code within a defined time window (start and end time), the defined Time Delay will be activated for the respective user group.

Time-Related Function "Toggle Dual Mode" activated (Bank Mode)

According to its configuration either in Single Mode or Dual Mode, the lock can be opened outside of defined time windows (start and end time).

Within a defined time window (start and end time) the lock switches from Single Mode to Dual Mode and vice versa for the respective user group.

Time-Related Function "Code Disabling" activated (Bank Mode)

Outside of defined time windows (start and end time) the lock can be opened according to its configuration.

Within a defined time window (start and end time) all codes of the respective user group are blocked.

It is only possible to open the lock with codes of the respective user group when the time window has elapsed.

11.6 Time-Related Functions with activated Partial Locking

Time-Related Function "Delay" activated (Bank Mode)

The lock can be opened outside of defined time windows (start and end time) and depending on how the lock was configured. The defined Time Delay (menu "Time-Related Time Delays") is valid for these configurations.

Partial Locking will be activated when the lock is opened for the first time after Time Locking has elapsed. The defined Time Delay (menu "Time-Related Time Delays") is not valid for this configuration.

The defined Time Delay starts after Partial Locking was activated and within a defined time window (start and end time) a valid opening code will be entered.

The defined Time Delay (menu "Time-Related Time Delays") is valid for the respective user group.

When Partial Locking is reset within a defined time window (start and end time) due to one of the events (Immediate Time Locking, Time Locking, Penalty, Remote Disabling), Partial Locking must be activated again when opening the lock the next time. The defined Time Delay (menu "Time-Related Time Delays") is not valid for this configuration.

Time-Related Function "Toggle Dual Mode" activated (Bank Mode)

According to its configuration either in Single Mode or Dual Mode, the lock can be opened outside of defined time windows (start and end time).

Partial Locking will be activated when the lock is opened for the first time after Time Locking has elapsed. "Toggle Dual Mode" is not valid for this configuration. The lock still opens when it was configured either in Single Mode or Dual Mode.

After Partial Locking is activated and within a defined time window (start and end time) "Toggle Dual Mode" will be executed. The lock changes from Single Mode to Dual Mode or vice versa. "Toggle Dual Mode" is valid for the respective user group.

When Partial Locking is reset within a defined time window (start and end time) due to one of the events (Immediate Time Locking, Time Locking, Penalty, Remote Disabling), the function must be activated again when opening the lock the next time. "Toggle Dual Mode" is not valid for this configuration.

Time-Related Function "Code Disabling" activated

Outside of defined time windows (start and end time) the lock can be opened according to its configuration.

Partial Locking will be activated when the lock is opened for the first time after Time Locking has elapsed. "Code Disabling" is not valid for this configuration.

After Partial Locking is activated and within a defined time window (start and end time) "Code Disabling" will be executed. "Code Disabling" is valid for the respective user group.

"Code Disabling" will be deactivated automatically after a time window has elapsed (end time) and even if Partial Locking remains activated.

When Partial Locking is reset within a defined time window (start and end time) due to one of the events (Immediate Time Locking, Time Locking, Penalty, Remote Disabling), the function must be activated again when opening the lock the next time. "Code Disabling" is not valid for this configuration.

11.7 Beep signals



It is possible to deactivate the beep signal via **AS284-USBW** or **AS284-NETW** programming software when the display shows "OPEN" (for open lock), "WAIT" (for Time Delay) and "CONF" (for Confirmation Window).

It is also possible to set the beep signal volume to high/low or to deactivate it.

Type of beep signal	Duration	Display	Cause
1 short beep			Key stroke
1 short, low-frequency beep		REFUSED	Action refused
1 short beep	Every 60 seconds	WAIT	Time Delay or Duress Time Delay is activated.
3 short beeps	Every 60 seconds	CONF	The Confirmation Window is activated. After the Time Delay is over, it is possible to enter the confirmation code.
10 short beeps	Every 10 seconds	BAT-CMP OPEN	The Battery Compartment was opened.
10 short beeps	Every 10 seconds	OPEN	The lock is open.

11.8 Status messages

11.8.1 Bank Mode and One Time Mode

Bank Mode

- Bank Mode is the factory setting and standard operating mode for all products.
- In Bank Mode the unit runs standalone according to the configuration.

Locked -3- (Bank Mode)

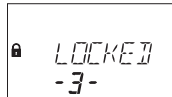

The lock -3- is mechanically closed.
 It is possible to connect up to 10 locks in a safe lock system.
 After 3 seconds the current time will be displayed instead of lock position.

Locked



The lock is mechanically closed.
 The current time is displayed.
 It is possible to open the lock by entering a valid code.

Open (Bank Mode)



The lock is mechanically open.
 The status message "OPEN" is displayed.
 It is possible to unlock the bolt work or safe door during the set Bolt Open Time.
 Factory setting for Bolt Open Time: 6 seconds.
 If the bolt work was not unlocked, the lock closes automatically after the set Bolt Open Time has elapsed.

Immediate Time Lock

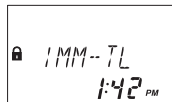

The lock is closed with the Immediate Time Lock function.
 It is not possible to open the lock, unless it was configured that the "Master can override Immediate Time Delay".
 The current time is displayed.
 It is only possible to open the lock by entering a valid code once the set locking period has elapsed.

Weekly Time Locking

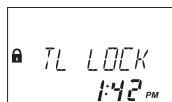

The lock is in a weekly locking period.
 It is not possible to open the lock, unless it was configured that the "Master can bypass Time Lock".
 The current time is displayed.
 It is only possible to open the lock by entering a valid code once the set locking period has elapsed.

Holiday Time Locking

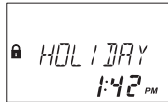

The lock is in a holiday locking period.

It is not possible to open the lock.

The current time is displayed.

It is only possible to open the lock by entering a valid code once the set locking period has elapsed.

NRTD

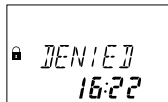

The lock is currently waiting for the Non-Return Time Delay (NRTD) to elapse.

It is not possible to open the lock during that time, unless it was configured to override with OTM code.

It is possible to use the **INFO/ESC** key to check the battery status and the last closed seal.



It is possible to configure different time delays for the code groups.

It is possible to set the Time Delay to "count down", "count up" or "do not count".

Opening Time Delay

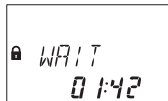

After entering a valid code to open the lock, the set Time Delay starts counting.

The remaining time is displayed.

Every 60 seconds a beep signal sounds.

After the counter has elapsed, the end of the Time Delay is indicated with another beep signal.

The Courier Code overrides a Time Delay, if not otherwise defined.

Confirmation after elapsed Time Delay



After the Time Delay has elapsed, a valid code must be entered as confirmation within a set time period.

It is possible to enter 2 different valid codes before and after the Time Delay.

The remaining time window is displayed to enter the code.

After entering the Courier Code, the **CONF** display is shown.

If the Courier Code opens the lock, but skips Time Delay, the opening procedure will start during the countdown.

Every 60 seconds a beep signal sounds.

If the code is not confirmed, the lock will return automatically to the closed status once the counter reached 00:00.



By pressing the **DEL** key, the lock automatically returns to the LOCKED status.

If the Dual Mode is activated, 2 codes must be entered as confirmation, the sequence is irrelevant.

The codes must comply with the settings made via AS284-USBW or AS284- NETW programming software: „any code“, „same code group“ or „different code group“.

Entering second code - Dual Mode activated



If the Dual Mode is activated, 2 codes must be entered to open the lock. The message shown on the display prompts the user to enter a second code.



Master Code and Courier Code override the Dual Mode. It is possible to open the lock without any additional code, if not otherwise defined.

Penalty after wrong codes

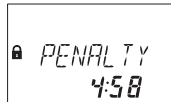

After having entered 4 times an incorrect code, a time penalty of 5 minutes is initiated. During this time period it is not possible to enter a code, neither to bypass nor to cancel the procedure. The remaining penalty time is displayed.

Remote Disabling

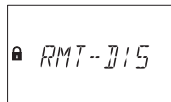

It is possible to deactivate the local opening of the lock by a remote disabling signal. There are 3 options to deactivate the lock opening:

- 1 By a constant input signal
- 2 Via AS284-USBW or AS284-NETW programming software or
- 3 by entering the User Codes 48 or 49, if the codes were set and if User Codes 48 and 49 are configured for lock enabling or disabling.

The status message **RMT-DIS** is displayed when Remote Disabling is activated. During that time the lock is closed.



Pay attention that User Code 49 was set, otherwise there will be a high risk of a lock-out.



In case of a failure caused by a device (a broken alarm interface or an alarm interface without power) transmitting an input signal, the Master Code is able to override Remote Disabling to prevent a total lock-out when the external signal fails.

Remote Enabling

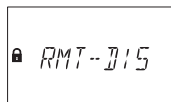

It is possible to activate a deactivated the lock via an external input signal to enter an opening code.

When Remote Enabling is activated, this status message will be displayed when the code window is open.

Remote Enabling is activated via an input impulse of at least 1 second.

Remote Enabling is deactivated after a successful opening or closing procedure.

Identification with denied code

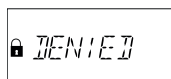

It is possible to deny codes with a superior code.
 These codes are declared invalid for a certain time period until these codes are permitted again.
 When identifying with a denied code, the status message **DENIED** will be displayed.
 The selected function will not be executed, the lock condition remains unchanged.
 The same status message will be displayed when trying to open the lock by using a Manager or the Master Code which was set as "can open lock".
 The status message **DENIED** will also be displayed as long as the set NRTD refuses to open the lock.



In Mixed Mode it is possible to configure the safe lock via AS284-USBW or AS284-NETW programming software so that a One Time Code is able to override NRTD.

Time-Related Functions



The number next to "TR-FNC" indicates the respective user group.
 The number below "TR-FNC" indicates the number of the activated Time-Related Functions of the respective user group.

The battery compartment was opened



The status message **BAT-CMP** is displayed if:

- 1 the lock is open while the battery compartment was opened
- 2 the lock is closed and the battery compartment was opened and closed again.

It is possible to delete the status message by entering a valid Manager, Master or Battery Code (User Codes 41, 42 or 47).

Connection to a programming software



The input unit is not operative and all keys are deactivated when the lock is connected to a computer via USB cable and data exchange with AS284-NETW programming software is in progress.



The input unit is not operative and all keys are deactivated when the lock is connected to a computer via LAN and data exchange with AS284-NETW programming software is in progress.

The graphic only shows the @ icon and no other information.

External power supply available (Bank Mode and OTM)



A dot is shown on the display if an external power supply is available for the lock or the eBox.
 This status message is updated every full hour.
 The graphic only shows the dot icon and no other information.

Active input unit

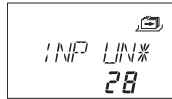

n input unit with asterisk indicates an active device with version number 28.

Passive input unit

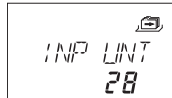

An input unit without asterisk indicates a passive device with version number 28.

Active eBox

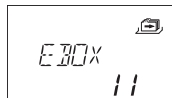

An active eBox with version number 11.

Passive eBox

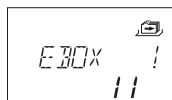

A passive eBox with version number 11.

11.9 Access codes

11.9.1 Code hierarchy and code formats

Several codes are available for configuring and operating:

- Master Code
- Manager Code
- User Codes
- Courier Code

Each code consists of:

- An 8-digit number which is composed of an ID and a PIN.
- The ID consists of 2 digits which are predefined and identify the code
- The PIN consists of the remaining 6 digits. It is possible to choose the PIN individually

Code type	Possible person in charge	Description
1 Master Code (8 digits)	Safety officer, head of security	<p>With the Master Code it is possible to open the lock without using any additional code, even if Dual Mode is set.</p> <p>It is possible to set the Master Code as "can open lock" in AS284-USB or AS284-NETW programming software.</p>

Code type	Possible person in charge	Description
4 Manager Codes (8 digits)	Head cashier, shift manager	It is possible to set the Manager Codes as "can open the lock" in AS284-USB or AS284-NETW programming software.
36 User Codes (8 digits)	Cashier, sales assistant	There are 4 user groups with 9 users each assigned to a respective Manager Code. It is possible to activate/deactivate the lock opening via AS284-USBW or AS284-NETW programming software.
1 Courier Code (8 digits)	Auditor, CIT (Cash In Transit service provider)	With the Courier Code it is possible to open the lock alone in Dual Mode. It is possible to set the lock "not open but skip Time Delay for the next opening" via AS284-USBW or AS284-NETW programming software.

Special code function	Description
Duress Code	If this function is activated, it is possible to execute the Duress Code by any of the code types.
Dual Mode	For the Dual Mode 2 codes are needed to open the lock. When opening the lock with Master Code or Courier Code, no second code is needed.
Code Denial	With this function it is possible to activate or deactivate individual codes or entire code groups.

11.9.2 Code types

The factory set Master Code **0 0 1 2 3 4 5 6** is identical for all locks of this type. This code must not be used for operation. Upon initialization and testing the Master Code must be changed.

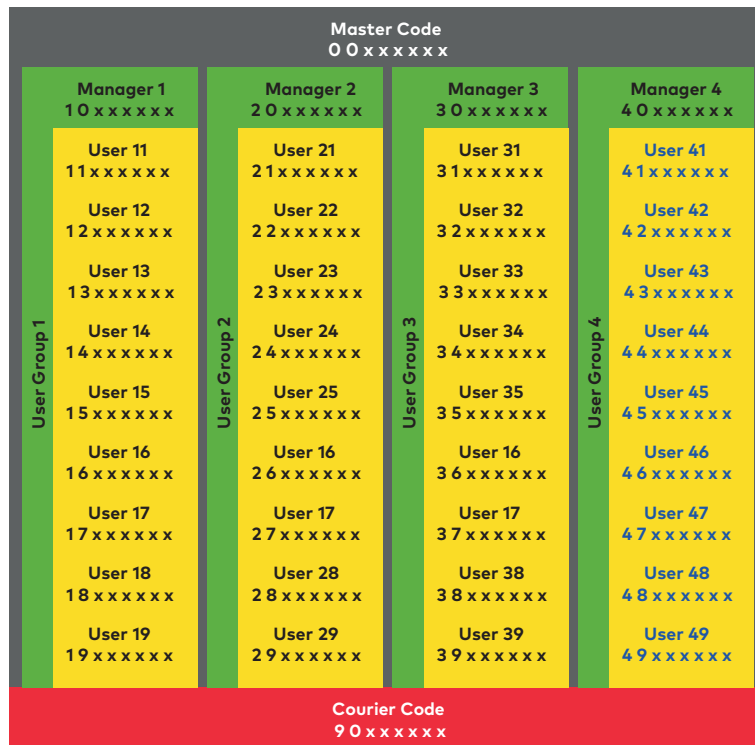

11.9.3 Master Code



It is important to personalize all codes of the unit during commissioning and start-up. Do not use easy number combinations such as 11223344, 12345678 or personal data (for example birthdays). For safety reasons it is important to change codes at regular intervals.

The Master Code is the highest code in the code hierarchy. It cannot be deleted.

Factory setting	0 0 1 2 3 4 5 6
Function	Opening the lock (even if only in Dual Mode) Changing all codes Access to all functions



It is only possible to delete and redefine lost codes with a higher code. Keep in mind that it is neither possible to retrieve nor to restore a lost Master Code. There is no super code.

Master Code function	Description	Displayed status message	Result
"Can open the lock"	The Master Code is entered to open the lock.	DENIED	The lock does not open.
"Can bypass Time Lock"	The Master Code is entered.		The lock opens even if it is in time locking period.
"Can override Immediate Time Lock"	The Master Code is entered and the function "can override Immediate Time Lock" is activated. The Master Code is able to reset the Immediate		The lock opens.

	Time Lock even during an activated Immediate Time Locking period.	
"Can override the remote disabled signal or remote disabled state"	The Master Code is entered. The Master Code is able to override a remote disabled signal or disabled state if a remote enabled signal is missing.	This prevents a complete lock-out.

11.9.4 Manager Codes

There are 4 Manager Codes available:

- Manager Code ID 10
- Manager Code ID 20
- Manager Code ID 30
- Manager Code ID 40

Each Manager Code is able to administrate a group of User Codes.

Factory setting	No code assigned
Function	Opening the lock Changing the Manager Code Activating, changing and deleting subordinated User Codes Allowing and denying subordinated user groups Changing the subordinated Time Delay and Confirmation Window Activating the Immediate Time Lock function

Manager Code function	Description	Displayed status message	Result
"Can open the lock"	The Manager Code is entered.	DENIED	The lock does not open.
"Cannot activate the Immediate Time Lock"	A Programming Mode is entered with the defined Manager Code setting.		The corresponding sub-menus are not accessible any more.
"Can change Time Delays"			
"Can change Confirmation"			
Dual Manager for Programming Mode	With this setting 2 Manager Codes are necessary to enter the Programming Mode		
Manager cross access User Codes	With this setting it is possible to change the codes of other user groups		

11.9.5 User Codes with special functions



Keep in mind that incomplete and improper configuration of the special functions "Lock disabling" (User Code 48) and "Lock Enabling" (User Code 49) causes a lockout. It is not possible to open the secure storage unit via the input unit any longer. The bigger the secure storage unit (e.g. an accessible secure storage unit), the higher the risk.

The set special function "Lock Disabling" prevents the lock from being opened with an opening code. Even the Master Code is not able to open the lock.

The set function "Lock Disabling" can only be deactivated by selecting and activating the special function "Lock Enabling" in AS284-USB or AS284-NETW programming software.

User Codes 48 and 49 must always be defined together when using the special functions "Lock Disabling" and "Lock Enabling".

The customer must allow access to AS284-USB or AS284-NETW programming software.

User Code	Description	Result
All User Codes	It is possible to define the User Codes as "can activate the Immediate Time Lock".	If this function is activated, all users have access to the submenu IMM-TL.
User Code 41	It is possible to set the User Code 41 via AS284-USBW or AS284-NETW programming software as Audit Code and Battery Code instead of an opening code. The User Code 41 cannot be used to open the lock when the special functions (Audit Code and Battery Code) are set. The User Code 41 must be configured in the software.	If the User Code 41 is set as Audit Code via AS284-USBW or AS284-NETW, the user can get an audit of the lock. When trying to open the lock with the User Code 41, the message "DENIED" will be displayed. If the User Code 41 is configured as Battery Code via AS284-USBW or AS284-NETW, the user can reset the battery message after the battery compartment had been opened.
User Code 42	It is possible to set the User Code 42 via AS284-USBW or AS284-NETW programming software as activation, Audit and Battery Code. The User Code 42 cannot be used to open the lock. The User Code 42 must be entered in the verification request of AS280-INSW software. AS280-INSW software is used to generate lock activation files. The IP activation file has the extension .i2x. The OTM activation file has the extension .dat or .Xdat.	It is possible to import the IP activation file in AS284-NETW programming software. It is possible to import the OTM activation file in AS274 management software. When trying to open the lock with the User Code 42, the message "DENIED" will be displayed. If the User Code 42 is configured as Battery Code via AS284-USBW or AS284-NETW, the user can reset the battery message after the battery compartment had been opened.

User Code	Description	Result
User Codes 45 and 46	<p>It is possible to define User Codes 45 and 46 as Impulse Code via AS284-USBW or AS284-NETW.</p> <p>It is possible to define the Impulse Code for each output of the lock or eBox via AS284-USBW or AS284-NETW (max. 2 outputs).</p>	<p>When entering either User Code 45 or 46 an impuls is generated on the respective output.</p> <p>If this function is activated, it is not possible to open the lock with the User Codes 45 and 46.</p>
User Code 47	<p>It is possible to define the User Code 47 as Time, Audit and Battery Code via AS284-USBW or AS284-NETW.</p>	<p>The User Code 47 has access to all functions relating time, date, weekly and holiday programs.</p> <p>It is not possible to open the lock with User Code 47.</p> <p>If the User Code 47 is configured as Audit or Battery Code via AS284-USBW or AS284-NETW, the user can either read the audit or reset the battery message after the battery compartment had been opened.</p>
User Code 48	<p>It is possible to define the User Codes 48 and 49 via AS284-USBW or AS284-NETW to deactivate or activate the lock opening.</p>	<p>When entering the User Code 48, the lock does not open, lock disabling is activated.</p> <p>The lock rejects any opening code.</p>
User Code 49		<p>When entering the User Code 49, lock enabling is activated.</p>

11.9.6 Courier Code

There is only 1 Courier Code (Courier Code ID 90) which is provided for special staff from Cash-In Transit services (CIT) responsible for filling or emptying secured containers without any configured Time Delays.

Factory setting:	No code assigned
Functions:	<p>Opening the lock, even in Dual Mode by bypassing a Time Delay</p> <p>Alteration of Courier Code</p>

Courier Code function	Description	Result
"Courier does not open but skips Time Delay"	<p>When entering the Courier Code to open the lock, the Time Delay will be skipped for the next opening.</p>	<p>The Confirmation Window countdown indicates the duration of this condition.</p> <p>The opening procedure must start during countdown.</p>

11.9.7 Duress Code

If the lock is connected to an external alarm system, it is possible for the operator to activate a silent duress alarm which is imperceptible for the aggressor.

It depends on the current operating mode in which way a duress alarm is activated.

The Courier Code always opens the lock with a time delay.

This behavior is irrespective of configured time delays and also applies in case of a possible threat.

11.9.7.1 Duress Code

To activate a duress alarm, the value 1 or a different value must be added to or deducted from the last digit of a code according to the configured duress criterion. It is possible to activate a duress alarm with all code types at any time.

Counting a Duress Time Delay is the same as counting a Time Delay: "count up", "count down" or "do not count".



It is possible to change the Duress Code criterion +/-1 ... +/-9 via AS284-USBW or AS284-NETW programming software .

Example for generating a Duress Code:

Code	Duress Code
00123456	00123457 or 00123455
00000000	00000001 or 00000009
00999999	00999990 or 00999998



After entering a Duress Code, the duress status remains until the Duress Time Delay has elapsed and the lock will be opened with 1 Non-Duress Code and closed again.

11.9.8 Shelfe Function

The Shelfe Function is only available if the Programming Mode is accessed with the Master Code.

With the Shelfe Function it is possible to reset all codes, parameters and data for example locking periods, time delays etc. to factory default settings.

The following settings remain unchanged:

- Audit Trail
- Opening Counter and
- Time/Date.

12 Access rights

Authorization is given to:

- MA (Master)
- Mx (Manager 1, 2, 3 and 4)
- U (User)
- C (Courier)

Menu	Function	Authorized codes (configured with input unit, ex factory)				Description
		MA	Mx	U	C	
TIME	Setting the time (hours, minutes) Setting the date (month, day, year) Setting the time format AM/PM (off: 24 hours / on: AM/PM) Setting DST (off/on: Central European Time)	✓	-	-	-	
PROG	Activating or deactivating the Immediate Time Lock (00:00 minutes) Duration (hours, minutes)	✓	✓	-	-	
PROG	Adding, changing or deleting Weekly Locking Periods Defining a starting and endpoint for Weekly Locking Periods (week-days, hours, minutes)	✓	-	-	-	
PROG	Adding, changing and deleting Holiday Locking Periods Defining a starting and endpoint for Holiday Locking Periods (week-days, hours, minutes)	✓	-	-	-	
PROG	Adding, changing or deleting Time Locking Interruptions Starting point (month, day, year, hours, minutes) Duration (minutes)	✓	-	-	-	

Menu	Function	Authorized codes (configured with input unit, ex factory)				Description
		MA	Mx	U	C	
PROG	<p>Configuring Time-Related Functions for user group 1, 2 or 3</p> <p>Defining a starting and endpoint for Time-Related Functions (hours, minutes)</p> <p>Delay (off/on, minutes)</p> <p>Toggle Dual Mode (off/on)</p> <p>Code Denial (off/on)</p> <p>Partial Locking (off/on)</p> <p>Weekly (off/on: week-days)</p>	✓	-	-	-	<p>User group 1 comprises all users of group 1, 1 Manager of group 1 and the Master.</p> <p>User group 2 comprises all users of group 2 and 1 Manager of group 2.</p> <p>User group 3 comprises all users of group 3 and 1 Manager of group 3.</p>
DELAY	<p>Setting and deactivating Time Delays for the Master Code and user group 1, 2, 3 or 4</p> <p>Selecting Time Delay 1, 2, 3 or 4 (minutes)</p> <p>Deactivating a Time Delay (00:00 minutes)</p>	✓	✓	-	-	<p>The Master Code is able to set all Time Delays.</p> <p>The Manager 1 is able to set the Time Delay 1. The settings of Time Delay 1 are valid for all users of group 1, Manager 1 and the Master Code.</p> <p>The Manager 2 is able to set the Time Delay 2. The settings of Time Delay 2 are valid for all users of group 2 and Manager 2.</p> <p>The Manager 3 is able to set the Time Delay 3. The settings of Time Delay 3 are valid for all users of group 3 and Manager 3.</p> <p>The Manager 4 is able to set the Time Delay 4. The settings of Time Delay 4 are valid for all users of group 4 and Manager 4.</p>
DELAY	<p>Configuring the Confirmation Window</p> <p>CNF WIN (minutes)</p>	✓	✓	-	-	

Menu	Function	Authorized codes (configured with input unit, ex factory)				Description
		MA	Mx	U	C	
DELAY	Configuring a Non Return Time Delay HM NRTD HM (hours, minutes)	✓	-	-	-	
MISC	Activating or deactivating the Beeper for Door Opening Alarm D-ALARM beep (off/on)	✓	-	-	-	
DELAY	Configuring the Beeper Time Delay for Door Opening Alarm D-ALARM (minutes, seconds)	✓	-	-	-	
MISC	Activating or deactivating Dual Mode DUAL bank (off/on)	✓	-	-	-	
DELAY	Configuring the window for a second code in Dual Mode DUAL bank (minutes, seconds)	✓	-	-	-	
DELAY	Configuring Bolt Open Time BLT OPN bank (minutes, seconds)	✓	-	-	-	
CODE	Changing the Master Code CHANGE ? (no/yes) Setting and confirming the Master Code (8 digits)	✓	-	-	-	It is not possible to delete the Master Code. The Master Code starts with '00'.
CODE	Setting Manager Codes 1, 2, 3 or 4 Setting and confirming Manager Codes (8 digits)	✓	-	-	-	The Manager 1 starts with '10'. The Manager 2 starts with '20'. The Manager 3 starts with '30'. The Manager 4 starts with '40'

Menu	Function	Authorized codes (configured with input unit, ex factory)				Description
		MA	Mx	U	C	
CODE	Changing Manager Codes 1, 2, 3 or 4 CHANGE ? (no/yes) Confirming a Manager Code (8 digits)	✓	✓	-	-	The Manager 1 starts with '10'. The Manager 2 starts with '20'. The Manager 3 starts with '30'. The Manager 4 starts with '40'
PROG	Deleting Manager Codes for Manager 1, 2, 3 or 4 CLEAR ? (no/yes)	✓	-	-	-	It is only possible to delete Manager Codes with the Master Code.
PROG	Setting User Codes for user group 1, 2, 3 or 4 Setting and confirming a User Code (8 digits)	✓	✓	-	-	User group 1 includes users '11' ... '19' User group 2 includes users '21' ... '29' User group 3 includes users '31' ... '39' User group 4 includes users '41' ... '49'
CODE	Changing User Codes for user group 1, 2, 3 or 4 CHANGE ? (no/yes) Setting and confirming User Codes (8 digits)	✓	✓	✓	-	
CODE	Deleting User Codes for user group 1, 2, 3 or 4 CLEAR ? (no/yes)	✓	✓	-	-	It is only possible to delete User Codes with a higher code.
CODE	Setting Courier Code Setting and confirming the Courier Code (8 digits) (8 digits)	✓	-	-	-	The Courier Code starts with '90'.
CODE	Changing Courier Code CHANGE ? (no/yes) Setting and confirming the Courier Code (8 digits)	✓	-	-	✓	
CODE	Deleting the Courier Code CLEAR ? (no/yes)	✓	-	-	-	It is only possible to delete Courier Code with the Master Code.

Menu	Function	Authorized codes (configured with input unit, ex factory)				Description
		MA	Mx	U	C	
CODE	Resetting the electronic safe lock (shelve) SURE ? (no/yes)	✓	-	-	-	
MISC	Setting the Display Language	✓	✓	-	-	
MISC	Managing the safe lock system with the Device Manager	✓	-	-	-	Slave locks have a limited range of functions compared to the master lock.
MISC	Activating or deactivating Remote Disabling RMT-DIS (off/on)	✓	-	-	-	
MISC	Setting the Beeper Volume VOLUME (off = 000 / medium = 001 / loud = 002)	✓	-	-	-	
MISC	Activating or deactivating Open Beeper OPEN beep (off/on)	✓	-	-	-	
MISC	Activating or deactivating the Beeper for Confirmation Window CNF WIN beep (off/on)	✓	-	-	-	
MISC	Activating or deactivating the Beeper Time Delay DELAY beep (off/on)	✓	-	-	-	
MISC	Activating or deactivating Waiting Time WAIT info (off/on)	✓	-	-	-	
MISC	Activating or deactivating the Language Info LANG info (each of the 10 languages is off/on)	✓	-	-	-	When a language is set to "on", the respective language will be displayed in the Info Menu.
MISC	Setting the Lock info LOCK info (off/on)	✓	-	-	-	It is only possible to set the Lock info with the master lock.

Menu	Function	Authorized codes (configured with input unit, ex factory)				Description
		MA	Mx	U	C	
MISC	Activating or deactivating Code Denial GROUP 1 (off/on) MANAG 1 (off/on) GROUP 2 (off/on) MANAG 2 (off/on) GROUP 3 (off/on) MANAG 3 (off/on) GROUP 4 (off/on) MANAG 4 (off/on)	✓	-	-	-	The Master Code is able to activate or deactivate each Manager or user group.
MISC	Activating or deactivating Code Denial GROUP 1 (off/on)	✓	✓	-	-	The Manager 1 is only able to activate or deactivate user group 1. When Code Denial is set to "on", the codes of user group 1 will be deactivated.
MISC	Activating or deactivating Code Denial Bank Mode GROUP 2 (off/on)	✓	✓	-	-	The Manager 2 is only able to activate or deactivate user group 2. When Code Denial is set to "on", the codes of user group 2 will be deactivated.
MISC	Activating or deactivating Code Denial Bank Mode GROUP 3 (off/on)	✓	✓	-	-	The Manager 3 is only able to activate or deactivate user group 3. When Code Denial is set to "on", the codes of user group 3 will be deactivated.
MISC	Activating or deactivating Code Denial Bank Mode GROUP 4 (off/on)	✓	✓	-	-	The Manager 4 is only able to activate or deactivate user group 4. When Code Denial is set to "on", the codes of user group 4 will be deactivated.
MISC	Activating or deactivating the Duress Code DURESS bank (off/on)	✓	-	-	-	

Menu	Function	Authorized codes (configured with input unit, ex factory)				Description
		MA	Mx	U	C	
MISC	Activating or deactivating One Shot Codes ONE SC4 bank (off/on)	✓	-	-	-	It is possible to activate One Shot Codes with user group 4. The Manager 4 will not be deleted when entering the Manager Code 40 and the function One Shot Codes is activated.
MISC	Setting the function Freeze FREEZE (off/on)	✓	-	-	-	It is only possible to set the function Freeze with the master lock.
	Resetting the battery message "BAT-CMP open"	✓	✓	-	-	The Master or a Manager Code must be entered to reset the battery message.
	Reading Audits in AS284-USBW or AS284-NETW	✓	-	-	-	The Master Code must be entered in AS284-USBW or AS284-NETW to read an Audit.
	Activating the lock in AS280-INSW for IP	✓	-	-	-	The Master Code must be entered in AS280-INSW to activate the lock for IP.

Menu	Function	Authorized codes (set in AS284-USBW or AS284-NETW programming software)		Description
		Mx	U	
TIME	Setting the time (hours, minutes) Setting the date (month, day, year) Setting the time format AM/PM (off: 24hours/on: AM/PM) Setting DST (off/on: Central European Time)	-	✓	User Code 47 can be used to configure this function when User Code 47 was set as Time, Audit and Battery Code.
PROG	Activating or deactivating the Immediate Time Lock (00:00 minutes) Duration (hours, minutes)	-	✓	The Immediate Time Lock is activated when users are enabled to activate this function.

Menu	Function	Authorized codes (set in AS284-USBW or AS284-NETW programming software)		Description
		Mx	U	
PROG	<p>Adding, changing or deleting Weekly Locking Periods</p> <p>Defining a starting and endpoint for Weekly Locking Periods (week-days, hours, minutes)</p>	-	✓	User Code 47 can be used to configure this function when User Code 47 was set as Time, Audit and Battery Code.
PROG	<p>Adding, changing and deleting Holiday Locking Periods</p> <p>Defining a starting and endpoint for Holiday Locking Periods (week-days, hours, minutes)</p>	-	✓	User Code 47 can be used to configure this function when User Code 47 was set as Time, Audit and Battery Code.
	Resetting the battery message "BAT-CMP open"	-	✓	<p>It is possible to reset the battery message when entering 1 of the following User Codes:</p> <p>User Code 41 set as Audit Code and Battery Code</p> <p>User Code 42 set as Activation Code, Audit Code and Battery Code</p> <p>User Code 47 set as Time Code, Audit Code and Battery Code</p>
	Reading Audits in AS284-USBW or AS284-NETW	-	✓	<p>It is possible to read Audits when entering 1 of the following User Codes in AS284-USBW or AS284-NETW:</p> <p>User Code 41 set as Audit Code and Battery Code</p> <p>User Code 42 set as Activation Code, Audit Code and Battery Code</p> <p>User Code 47 set as Time Code, Audit Code and Battery Code</p>

Menu	Function	Authorized codes (set in AS284-USBW or AS284-NETW programming software)		Description
		Mx	U	
	Activating the lock in AS280-INSW for IP	-	✓	It is possible to activate the lock in in AS280-INSW for IP when User Code 42 was set as Activation, Audit and Battery Code.
	Activating output impulses with User Codes	-	✓	When entering either User Code 45 or 46 to activate an impuls on an output. Use AS284-USBW or AS284-NETW to define up to 2 outputs of the lock or 2 outputs of the eBox.
	Use AS284-USBW or AS284-NETW to define up to 2 outputs of the lock or 2 outputs of the eBox.	-	✓	User Codes 48 and 49 must be defined together when both codes are configured to enable and disable the lock. The User Code 49 must be entered to activate the lock (codes are accepted). The User Code 48 must be entered to deactivate the lock (all codes are denied).

13 Unpacking and checking delivery

13.1 Checks before installation

Requirements:

- Unpack the delivery.
- Make sure that the content is complete.

Make sure that the delivery includes:

- Input unit
- Lock
- Connecting cable
- Plastic bag with installation material
- 3 professional alkaline batteries, industrial by DURACELL®
- Instruction leaflet with further information and reference to the website

Make sure that the optional eBox delivery includes:

- eBox
- Connecting cable
- A label with eBox pin assignment
- Plastic bag with installation material

Make sure that the optional computer software packages include:

- **AS280-INSW:** USB cable, 1 installation dongle (red), 1 instruction page
- **AS284-USBW:** USB cable, 1 operator dongle (blue), 1 instruction page
- **AS284-NETW:** USB cable, 2 administrator dongles (orange), 2 operator dongles (blue), 1 instruction page

14 Installation

NOTICE

Lockout of secure storage units

Closing the door of a secure storage unit while lock installation is not fully completed, will cause a lockout of secure storage units.

- Do not close the door of a secure storage unit until all installation steps are successfully completed.

14.1 Drilling templates

Input unit template

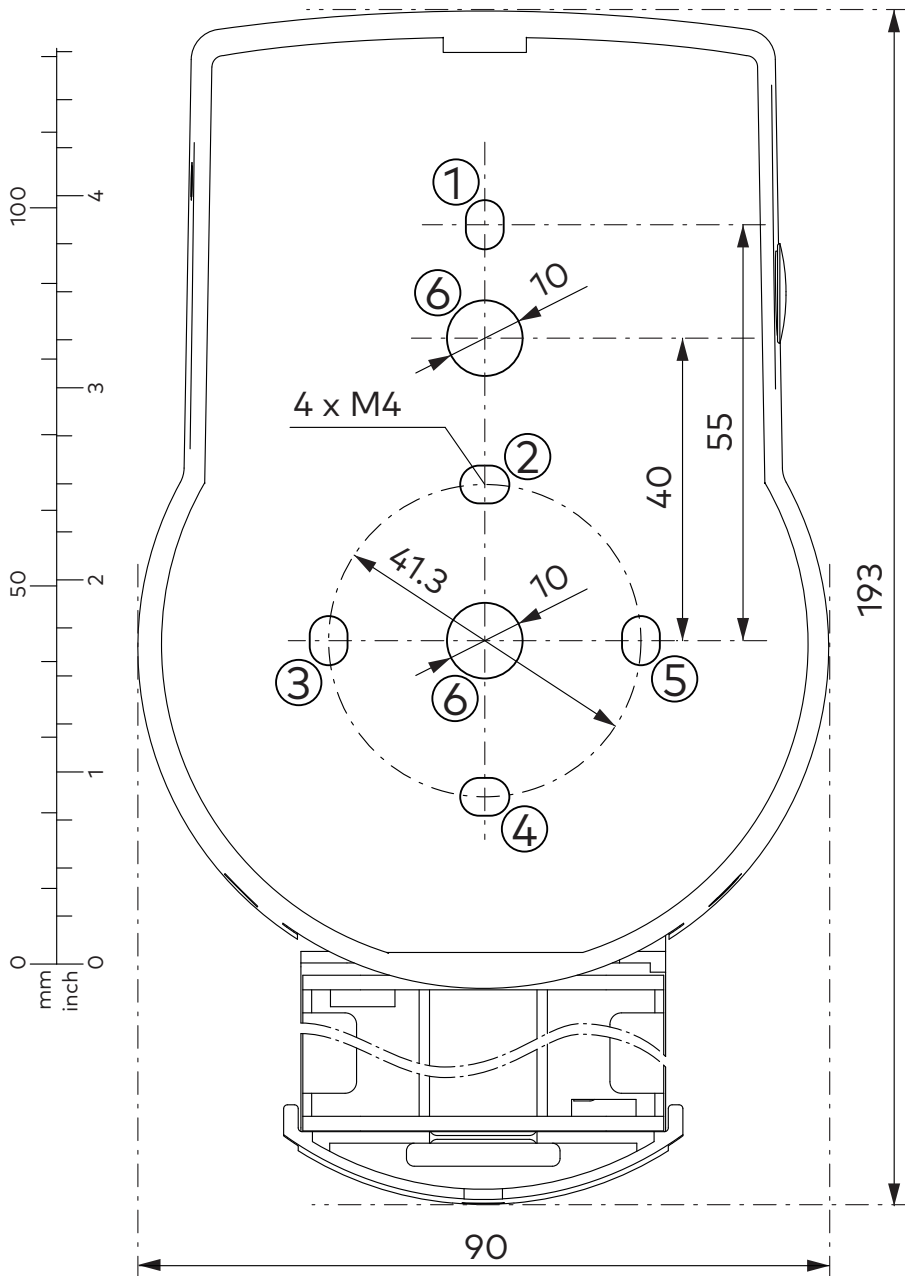

Lock template

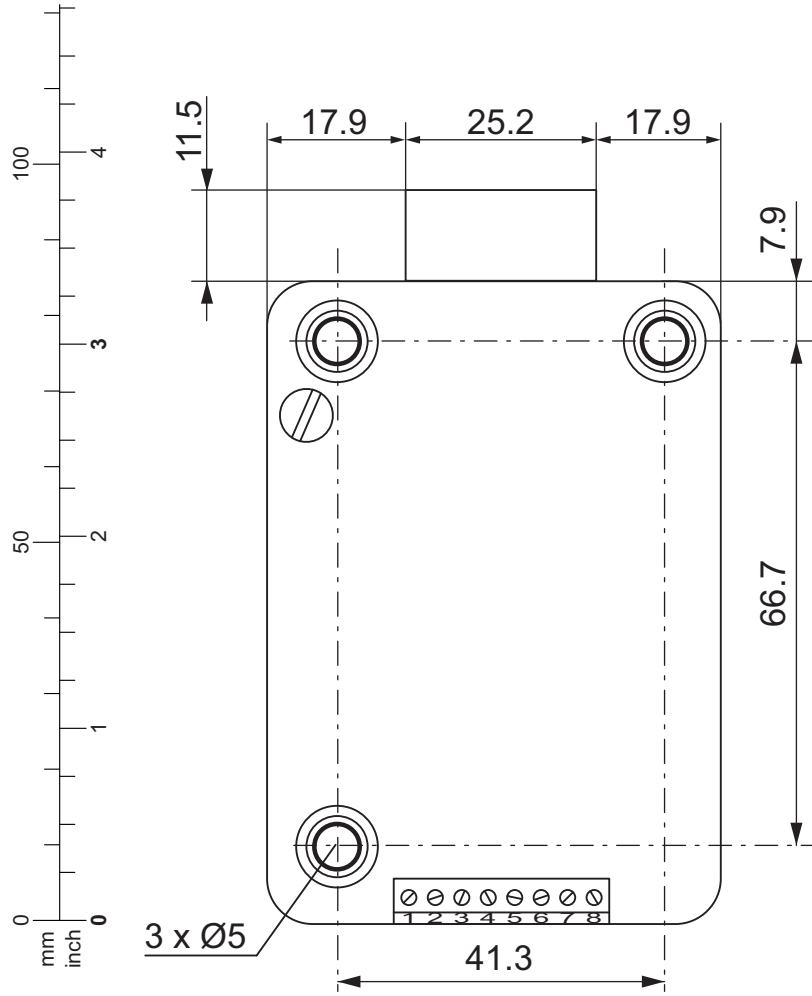

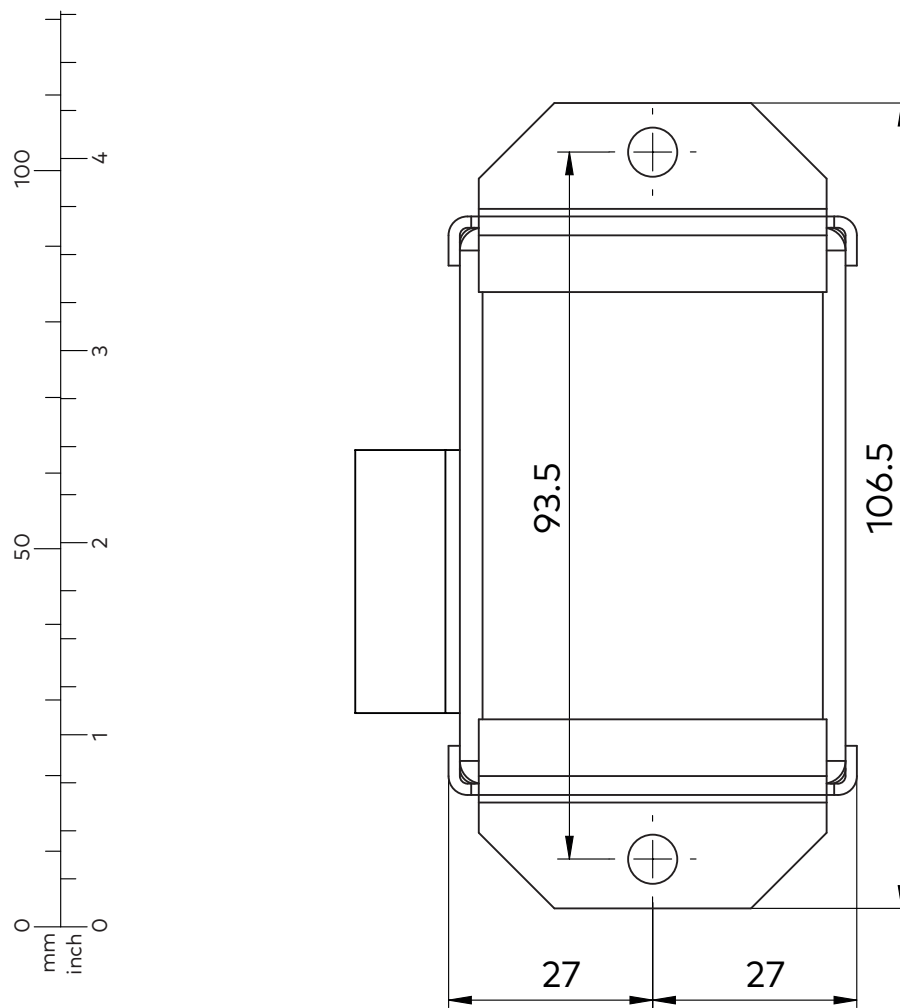
eBox template (optional unit)

14.2 Installing the input unit

NOTICE**Improper installation of the input unit**

Changing the installation sequence will cause damage to the input unit

- Do not skip installation steps.
- Follow the described installation sequence.



As a requirement of EN 1300 the input unit must be installed onto the safe.

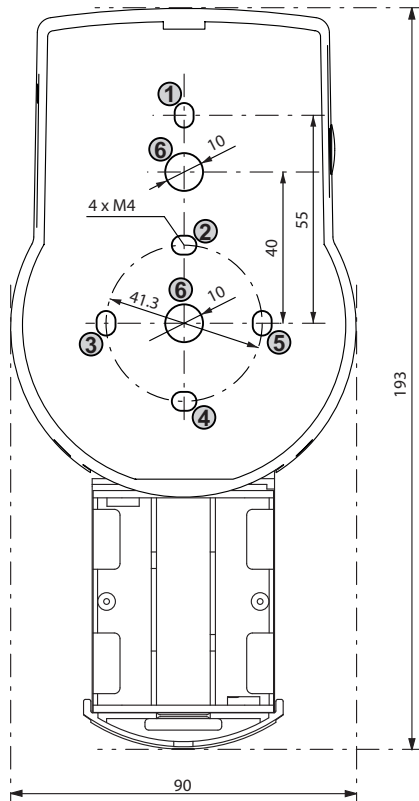

Installing the base plate



If the lock is installed directly behind the spindle hole and no other measure was chosen, a drill protection plate is required for UL approved retrofit installation.



Fastening screws must be secured against loosening, e.g. by using threadlocking adhesive such as Loctite 243 (medium strength, blue).

1. Use the drilling template.
2. Mark either fixation holes 3 and 5 or 2 and 4 plus fixation hole 1.
3. Also mark the fixation hole 6 for the cable feed-through.
4. Drill 3 fixation holes $\varnothing 3.2 \times 14$ mm.
5. Drill 1 hole $\varnothing 10$ mm for the cable feed-through.
6. Remove burrs.

7. Install M4 threads into the fixation holes.



8. Remove the 3 screws from the bottom of the cover (1 installed in the battery compartment, 2 installed in the housing).
9. Remove the cover from the base plate.
10. Carefully remove the battery compartment.
11. Install the base plate with the special M4x12 flat-head screws onto the door.
 - ⇒ The input unit must be installed onto the door with at least 2 oppositely positioned screws.
 - ⇒ The third screw is recommended (position 1).

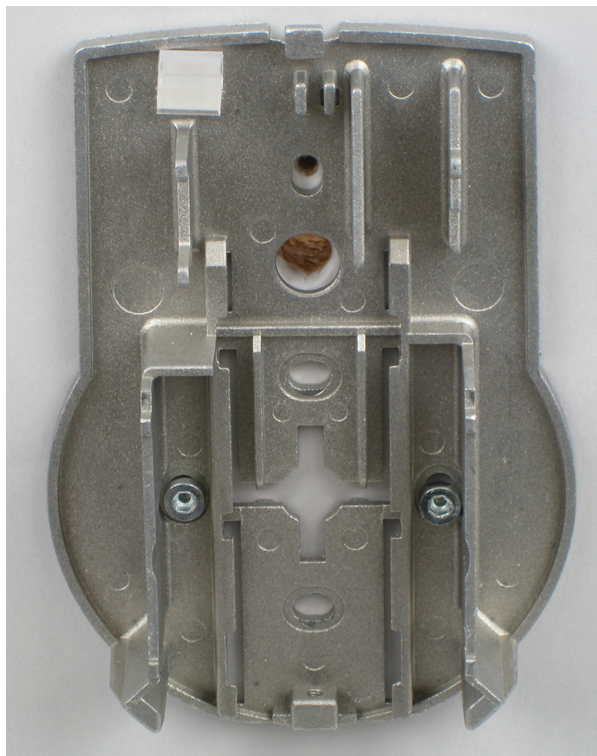

NOTICE

Excessive mechanical stress on cables

Excessive mechanical stress on cables will cause damage to the insulation and conductor.

- Keep cables away from moving parts.
- Do not squeeze cables.
- Do not fold cables.
- Do not route cables along sharp edges.

Connecting cables

1. Carefully route the connecting cable through the Ø10mm cable feed-through in the door.
2. Carefully feed the connecting cable into the lock chamber.

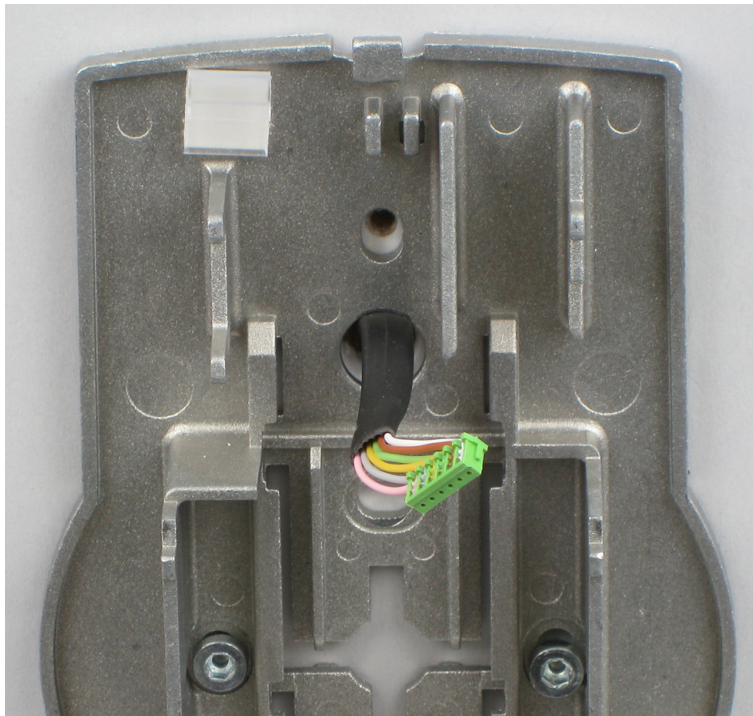

Installing the battery compartment

Requirements:

- Make sure not to squeeze the cable.
 - Make sure that the battery compartment is freemoving.
 - Make sure that the spiral cable is flattened when moving the battery compartment.
 - Make sure that the spiral cable does not move in other directions when it is extended and compressed.
1. Install the battery compartment in place.

2. Carefully route the battery cable through the strain relief guides of the battery compartment and the base plate.

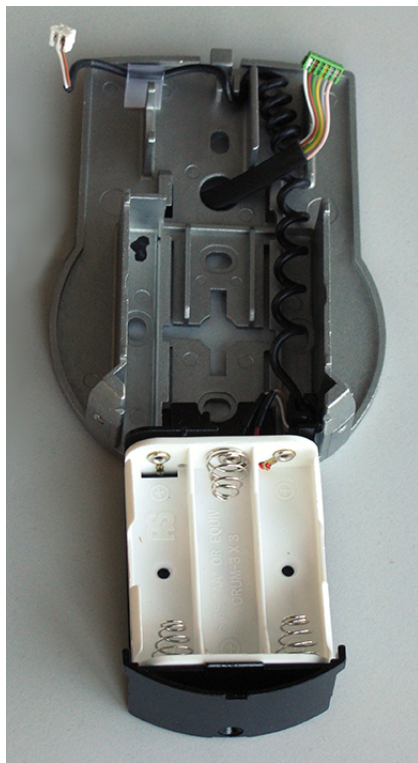

3. Place the cover on top of the base plate in an angle $>90^\circ$.



4. Plug the battery cable into the 2-pole connector terminal and the connecting cable into the 6-pole connector terminal.
5. Make sure that the position of the plugs is correct before connecting the plugs.
6. Do not use excessive force to plug-in, but make sure that proper connection is given.

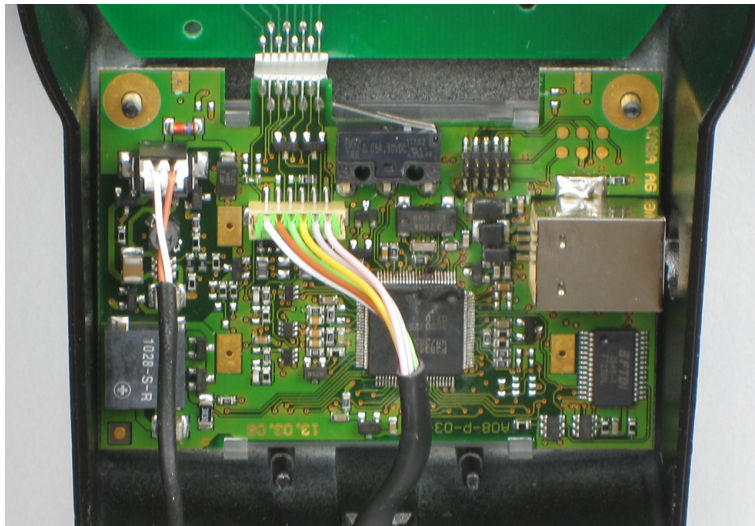

Installing the cover

1. Engage the cover in the notch on top of base plate.
2. Slowly hinge down the cover onto the base plate while carefully routing the connecting cable to the lock chamber.
3. Leave a spare loop.
4. Make sure that the cables will not be squeezed.
5. Make sure that the battery compartment is freemoving.
6. Carefully place the battery compartment in the right position.
7. Remove it again.



8. Install the cover onto the base plate using 2 M3x6 countersunk screws.



9. Make sure that the battery compartment is freemoving.
10. Carefully place the battery compartment in the right position.
11. Remove it again.
12. Do not put the batteries into the battery compartment.
13. Do not install the screw for the battery compartment yet.

14.3 Installing the lock



Do neither remove nor damage the warranty seal.
This voids warranty.



Do neither remove nor damage the VdS label.
This voids VdS approval.



The fixation holes of the drilling template are standardized.

1. Mark 3 fixation holes (A) according to the drilling template for input unit.

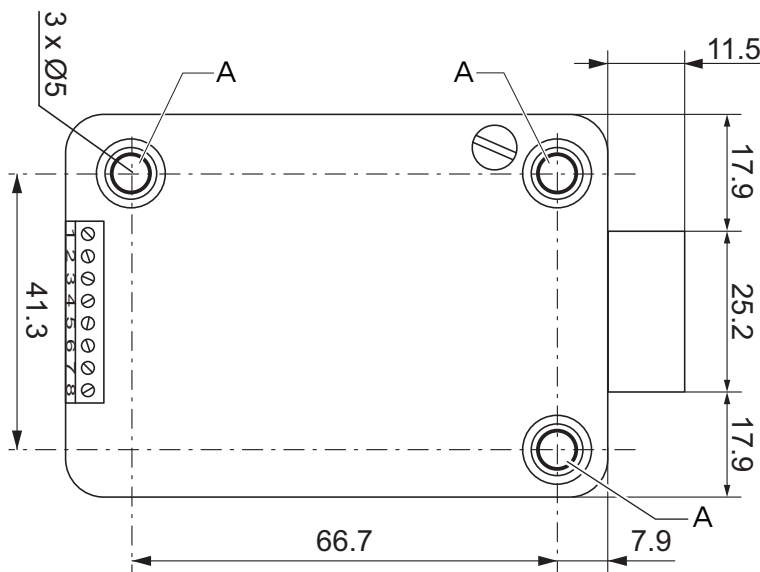

2. Drill fixation holes with Ø5mm.

3. Remove the burrs.
4. Install M6 threads into the fixation holes.
5. Install the lock with the three M6x10 screws (it is also possible to use similar inch screws).
6. Make sure that the screw heads rest on the base of the shouldered fixation hole.
7. Make sure to keep the space underneath the lock free for a re-closable system or a connecting cable.
8. If the lock is to be operated in spring bolt function, remove the retainer screw (B) underneath the VdS label.

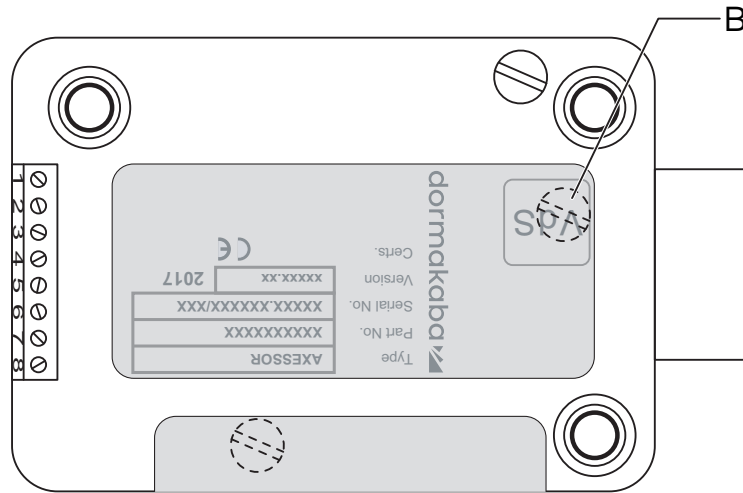

Pay attention that the operating mode in spring bolt function voids VdS approval.

9. If needed, use two M4 threads in the front end of the lock bolt to fasten an extension.

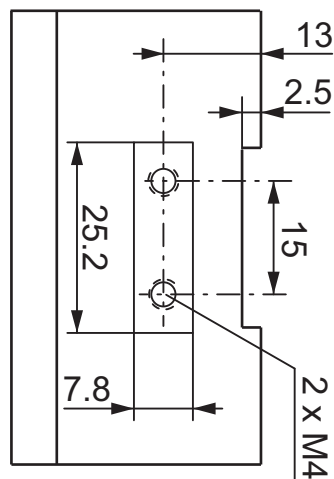

10. Observe the maximum force of 5N in both directions.

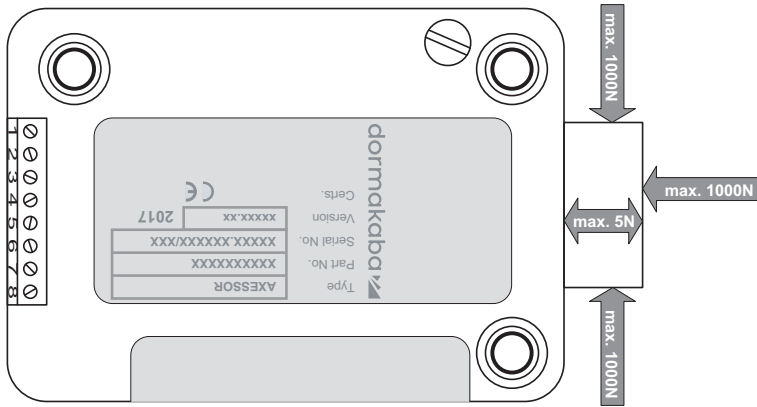

Connecting the connecting cable

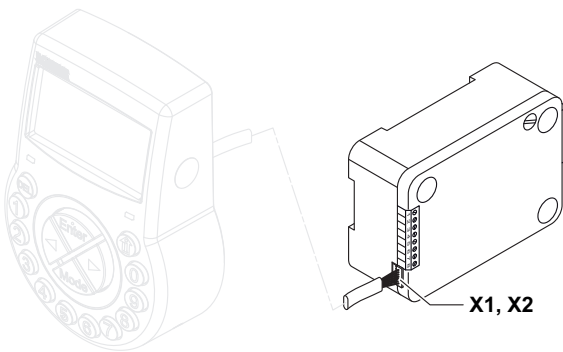

1. Make sure that the connector is in the correct position.
2. Carefully plug the connecting cable into 1 of the lock sockets X1 or X2.
3. Tighten the connecting cable with the cable tie and carefully attach excess cable.

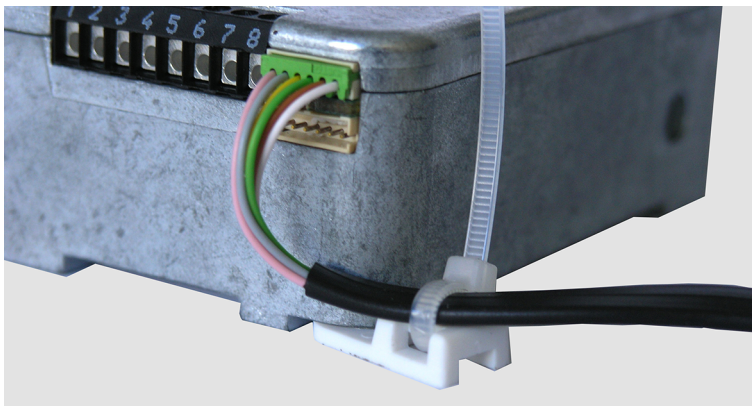

14.4 External connections on the lock

The configuration of input 2 and the corresponding terminals 7 and 8 is realized via AS284-USB or AS284-NETW programming software. Input 2 operates with inverted logic.

When input 2 is assigned as "door contact" and the checkbox "invert contact (open contact to trigger)" is not selected in AS284-USB or AS284-NETW programming software, the lock evaluates the open lock terminals 7 and 8 being electrically disconnected as "door open".

Once the lock is open, the bolt remains as long open as the terminals 7 and 8 are open.

When a micro switch is connected to input 2 and the closed micro switch indicates the status "door open", both checkboxes "Invert input (open contact to trigger)" and "door contact" must be selected in AS284-USBW or AS284-NETW programming software for a smooth operation.



It is possible to connect additional external signals to the lock terminal block.

It is possible to change the function and polarity of inputs and outputs with AS284-USBW or AS284-NETW programming software.

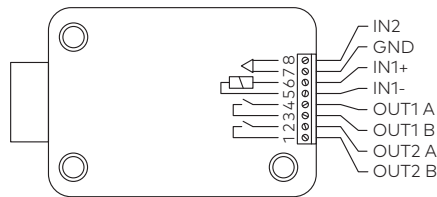

Terminals	Description	Unit	Remarks
1/2	Output 2 Factory setting: lock open (OR Boolean operation with bolt, motor or door open)	30VDC/2A	Relay with potential-free working contacts NO (normally open). Contact is open when lock is closed.
3/4	Output 1 Factory setting duress alarm	50VAC/0.5A with resistive load	Relay with potential-free working contacts NO (normally open). Contact is closed when duress alarm is activated.
5(-)/6(+)	Input 1 Factory setting not assigned Optional: remote disabling or controlled disabling	9 ...18VDC (minimum 13mA and maximum 20mA)	
7/8	Input 2 Factory setting: not assigned, configurable via AS284-USBW or AS284-NETW programming software Optional: <ul style="list-style-type: none"> • Door contact • Skip Time Delay • Time Locking Interruption and • external input event A - F 	Potential-free contact	Do not apply any voltage, potential-free contact only. Use a suitable micro switch with gold-plated contacts 12VDC/50mA (e.g. DB series by Cherry). If input 2 is assigned as "door contact" and not inverted, an open switch contact is used as "door open". The bolt is as long open as terminals 7 / 8 are electrically disconnected.

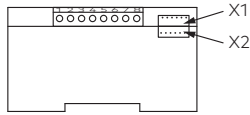

Sockets	Description	Remarks
X1, X2	Connection for input unit or eBox or connection for power supply	Use the enclosed connecting cable. Only use the original Axessor power supply.

14.5 Installing the eBox



As a requirement of EN 1300 the eBox must be installed inside the safe.

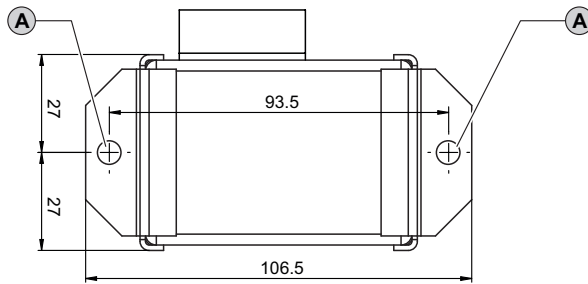

1. Mark 2 fixation holes (A) according to the graphic.
2. Drill fixation holes $\varnothing 5$ mm.
3. Remove the burrs.
4. Install M6 threads in the fixation holes.
5. Install the eBox with two M6x10 socket screws (it is also possible to use similar inch screws instead).

Connecting cable



Keep in mind that the VdS label becomes void when connecting the network cable to the RJ45 socket of the eBox.

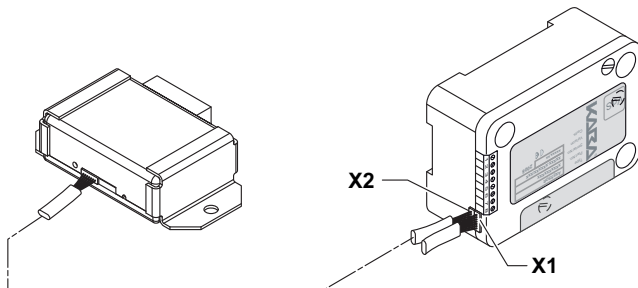

1. Make sure that the connector is correctly positioned.
2. Carefully connect the eBox connecting cable to one of the eBox sockets and one of the lock sockets X1 or X2.

14.6 External connections on the eBox



Do not power the eBox before starting the wiring procedure.

Requirements:

The eBox functions are only available if:

- the eBox is connected to an Axessor lock
- the eBox is connected to a power supply.

The eBox provides:

- 5 additional inputs and 4 additional outputs
- 2 bus sockets
- 1 RJ45 socket.
- a longer battery lifetime since the eBox acts as power supply.



It is possible to assign functions of inputs and outputs via AS284-USBW or AS284-NETW programming software.

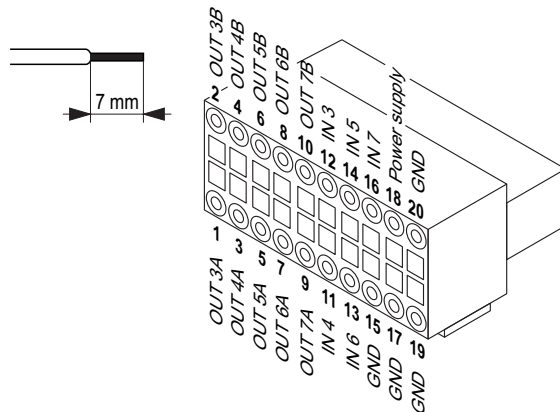

Terminal	Description	Unit
18/20	Power supply	9 ... 26VDC / 700 ... 200mA
1/2	Output 3 Factory setting: not assigned	Contact properties Switching voltage: 24VAC Load current: 0.4A at 25°C 0.3A at 50 °C Internal output impedance: maximum 20hm
3/4	Output 4 Factory setting: not assigned	
5/6	Output 5 Factory setting: not assigned	
7/8	Output 6 Factory setting:: not assigned	
9/10	Output 7 Set for "external power"	Relay with potential-free working contacts (NO normally open)

Terminal	Description	Unit
12/GND	Input 3 Factory setting: not assigned	Internal input impedance: min. 4kOhm Input switch impedance: max. 10kOhm 9 ... 18VDC (min. 5mA)
11/GND	Input 4 Factory setting: not assigned	
14/GND	Input 5 Factory setting: not assigned	
13/GND	Input 6 Factory setting: not assigned	
16/GND	Input 7 Factory setting: not assigned	



Keep in mind that the VdS label becomes void when connecting the network cable to the RJ45 socket of the eBox.

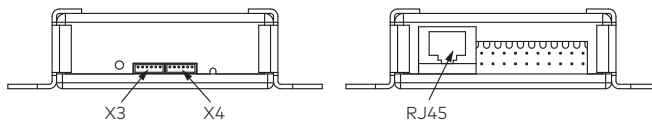

Socket	Description	Remarks
X3 or X4	Connection to lock (it is only possible to connect 1 lock to an eBox). It does not matter if X3 or X4 is uses.	Use the enclosed connecting cable.
RJ45	Connection to a LAN	10/100 Base T Ethernet Min. CAT5 cable required. Connecting network devices must have a ground connection.

14.7 eBox wiring diagram

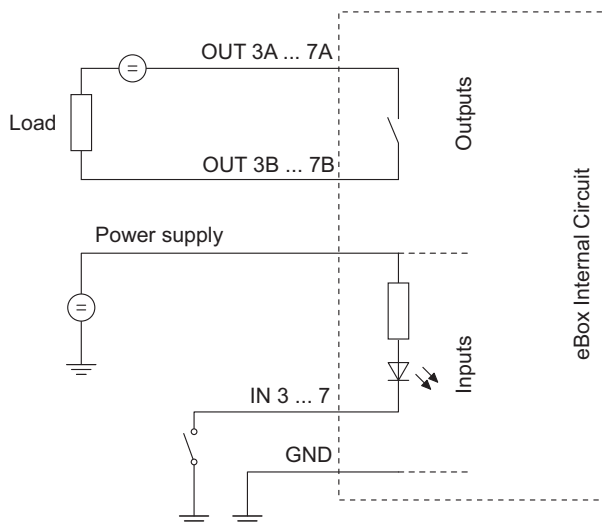

14.8 Wiring

There are 2 options to set up a safe lock system:

- Cold plugging
- Hot plugging

The higher the number of used components and the bigger the distances between the components, it is important to follow this rule:

- To create a wiring loop if the distance between the components is rather high.
- To connect either the eBox or the power supply with a maximum distance from the input unit.

14.8.1 Cold plugging



When wiring a safe lock system neither put batteries in the battery compartment nor connect an external power supply to the last position of the safe lock system. Do not power the eBox either.

The following instruction describes the setting up of a standard safe lock system with all optional devices (a second input unit, two eBoxes and an external power supply).

It is assumed that the locks have only factory settings.

The functions Freeze and Lock info are set to OFF on the master lock.

Connecting an input unit and locks

1. Connect the connecting cable from the 6-pole connector terminal of the input unit to terminal X1 of the first lock.
2. Connect the connecting cable from terminal X2 of the first lock to terminal X1 of the second lock.
3. Repeat the step before for the remaining locks.

Connecting locks and optional eBox

1. Connect the connecting cable from terminal X2 of the last lock to terminal X3 of the eBox.
2. Connect the power supply to the eBox via the 20-pin plug.
3. Do not connect the power supply of the eBox to the line voltage.
4. Repeat the same steps with a second optional eBox.

Connecting an optional external power supply

1. Plug the external 6 VDC power supply to terminal X2 of the last lock.
2. Do not connect the power supply to the line voltage.

Connecting a second optional input unit

1. Connect the connecting cable from terminal X2 of the last lock or terminal X4 of the eBox to the 6-pole connector terminal of the second input unit.
2. Do not put batteries in battery compartment of the second input unit.

Powering the safe lock system



Pay attention to the polarity of the batteries.

1. Carefully pull out the battery compartment until it comes to a stop.
2. Put 3 professional alkaline batteries, industrial by DURACELL® into the battery compartment of only 1 input unit. according to the markings of the receptacle.

3. Connect the power supply to the line voltage.
 - ⇒ After having finished this procedure, the safe lock system initializes itself. A test routine will be initiated.
 - ⇒ The following displays appear one after another and a beep signal sounds. The version number can vary.

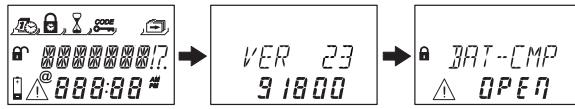

4. Close the battery compartment.
5. Wait until the error message BAT-CMP OPEN appears again.



6. Confirm the error message by entering the current Master code (default: 00123456) with **NUMERIC** keys.
7. Press the **ENTER** key.
 - ⇒ The lock opens and after approximately 6 seconds it closes again.



8. Tighten the battery compartment with hexagon countersunk screws.
9. Repeat the steps before for each lock.

The lock with the lowest serial number becomes the master lock, see Troubleshooting for identification of serial numbers.

The display shows LOCKED and the number of the lock position. The master lock is lock -1-. The slave locks have successive numbers from lock -2- to lock -10-. The assignment of the lock positions is random.

The "MOVE" command of the Device Manager must be used to assign the desired lock positions with the master lock.

When the eBox is connected to the safe lock system, the eBox will be paired automatically with lock -1-.

14.8.2 Hot plugging



After a power interruption and the function Freeze was set to OFF, the safe lock system will initialize itself newly.

The safe lock system behaves as if it were set up according to the procedure cold plugging. The lock with the lowest serial number becomes the master lock.

To prevent the safe lock system from changing its lock positions, the function Freeze must be set to ON after connecting the first lock. The first lock becomes the master lock.

The function Freeze must be set to OFF to continue setting up the safe lock system.



Power interruption includes: the batteries are empty and the line voltage is off or the batteries will be replaced and the line voltage is off.



Pay attention to the polarity of the batteries.

Before wiring a safe lock system put the batteries in the battery compartment of only 1 input unit.

It is assumed that the locks have only factory settings.

The functions Freeze and Lock info are set to OFF on the master lock.

Connecting the input unit and the master lock

1. Carefully pull out the battery compartment until it comes to a stop.

2. Put 3 professional alkaline batteries, industrial by DURACELL® into the battery compartment according to the markings in the receptacle.
3. Connect the connecting cable from the 6-pole connector terminal of the input unit to terminal X1 of lock -1-.
 - ⇒ The lock -1- becomes the master lock.
 - ⇒ After connecting the lock, a test routine will be initiated. The following displays appear one after another and a beep signal sounds. The version number can vary.



4. Close the battery compartment.
5. Wait until the error message BAT-CMP OPEN appears again.

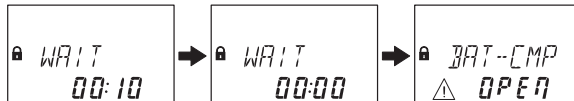

6. Confirm the error message by entering the current Master Code (default: 00123456) with **NUMERIC** keys.
7. Press the **ENTER** key.
 - ⇒ The lock opens. After approximately 6 seconds it closes again.



8. Tighten the battery compartment with hexagon countersunk screws.

Connecting the slave locks

1. Connect the connecting cable from terminal X2 of lock -1- to terminal X1 of lock -2- .
2. Repeat the step before for the remaining slave locks.
 - ⇒ A test routine will be initiated. When the error message BAT-CMP OPEN appears, the Master Code must be entered.

Connecting locks and optional eBox

1. Connect the connecting cable from terminal X2 of the last lock to terminal X3 of the eBox.
2. Connect the power supply to the eBox via the 20-pin plug.
3. Connect the power supply of the eBox to the line voltage.
 - ⇒ When the eBox is connected to the safe lock system, the eBox will be paired automatically with lock -1-.
4. Repeat the same steps with a second optional eBox.

Connecting an optional external power supply

1. Plug the external 6 VDC power supply to terminal X2 of the last lock.
2. Connect the power supply to the line voltage.

Connecting a second optional input unit

1. Connect the connecting cable from terminal X2 of the last lock or terminal X4 of the eBox to the 6-pole connector terminal of the second input unit.
2. Do not put batteries in battery compartment of the second input unit.

Safe lock system after finalized hot plugging procedure

The display shows LOCKED and the number of the lock position. The master lock is lock -1-. The slave locks have successive numbers from lock -2- to lock -10-. The assignment of the lock positions corresponds to the sequence of the connected locks.

14.8.3 Wiring options

Wiring the door contact



Interlocking of multiple locks

Example for 1 lock opens at a time within a safe lock system with 3 locks.

The following settings must be entered in AS284-USBW or AS284- NETW programming software:

- Output 2 = bolt or motor open
- Input 1 = controlled disabling

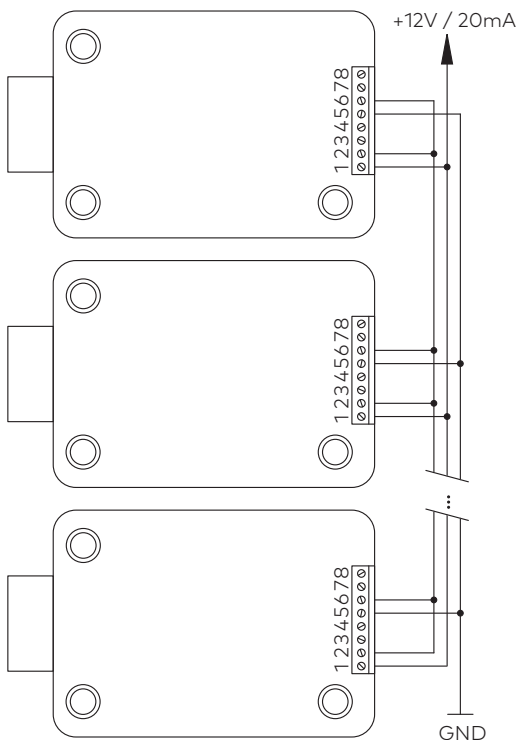

14.9 Wiring check of the lock

Requirements:

To perform a wiring check, all doors and drawers must be open. If during the wiring check the error message LINE OFF appears continuously:

- Make sure that all connecting cables are connected correctly.
- Make sure that no connecting cable is damaged.

- Disconnect the connecting cables and replace them, if necessary.
- Connect the connecting cables again.
- Make sure that new batteries were put into the battery compartment, see Device Manager (bus system test).
- If another error message appears, see Troubleshooting.

14.10 Wiring check of the eBox

After finishing the installation, the Axessor CIT electronic safe lock is commissioned:

- Conduct wiring check.
- After an initialization period if the eBox is connected, the LED blinks twice green every 2 seconds.

15 Configuration



15.1 Programming Mode

The Programming Mode changes factory set parameters, settings, codes and other functions. It depends on the programming level which codes are required.

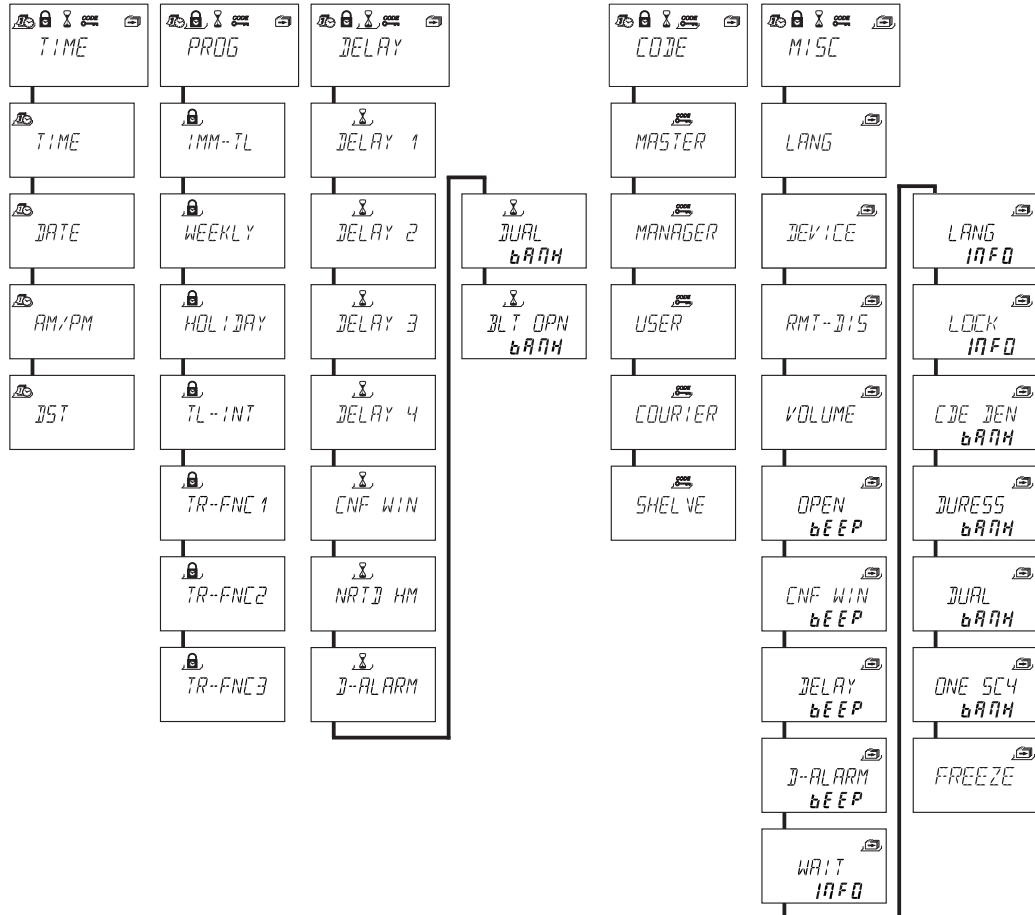
15.1.1 Menu overview of the master lock



Symbol	Menu	Function	Submenu
	TIME	setting time, date and time format	TIME DATE AM/PM DST
	PROG	configuring locking periods	IMM-TL WEEKLY HOLIDAY TL-INT TR-FNC 1 TR-FNC 2 TR-FNC 3
	DELAY	configuring time delay	DELAY 1 DELAY 2 DELAY 3

Symbol	Menu	Function	Submenu
			DELAY 4 CNF WIN NRTD HM D-ALARM DUAL bank BLT OPN bank
 CODE	CODE	changing codes	MASTER MANAGER USER COURIER SHELVE
	MISC	accessing additional functions	LANG DEVICE RMT-DIS VOLUME OPEN beep CNF WIN beep DELAY beep D-ALARM beep WAIT info LANG info LOCK info CDE DEN bank DURESS bank DUAL bank ONE SC4 bank FREEZE

15.1.2 Accessing the Programming Mode



It is only possible to access the Programming Mode if the lock is open.
The lock must remain open during configuration.

1. Open the lock.



2. Press the **MODE** key.

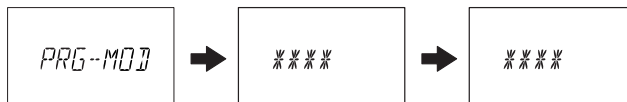

3. Enter a code, for example 00023054 by using the **NUMERIC** keys.
4. Confirm the code with the **ENTER** key.



- ⇒ Now the lock is in Programming Mode.
- ⇒ The main menu is displayed.
- ⇒ The content of the main menu depends on the entered code.

15.1.3 Navigating in Programming Mode



If during 1 minute no key was pressed, the input unit switches automatically to operating mode and the display switches off.

All changes, which have not been confirmed with the **ENTER** key, will be lost.

With **LEFT** and **RIGHT** key it is possible:

- to scroll to a menu item in the main menu or submenu
- to select an individual digit or an entry field from the settings display.

With the **ENTER** key it is possible:

- to confirm settings and selections.

With the **INFO/ESC** key it is possible:

- to exit a setting or submenu without action and to go to the next higher menu level.
- to exit the programming mode and change to operating mode.

With the **DEL** key it is possible:

- to delete selected data from a submenu or a menu item.

15.1.4 Changing and saving settings



It is possible to interrupt the modification dialog at any time without saving.

By pressing the **DEL** key or **INFO/ESC** key once or several times before entering the submenu.

1. Select the desired setting in the menu, for example "time".
2. Press the **Enter** key.



3. Select the desired subsetting and change the subsetting.



4. Press the **ENTER** key to confirm the subsetting.
 5. Select "YES" in the "SAVE?" dialog by using the **LEFT** or **RIGHT** arrow key.
 6. Press the **ENTER** key.
- ⇒ The message "Accepted" appears shortly and the input unit switches to the corresponding subsetting.

15.1.5 Exiting the Programming Mode

1. Press several times the **DEL** key or **INFO/ESC** key to return to operating mode.

15.1.6 Menu TIME

15.1.6.1 Setting the time

Authorization: Master code



To enable programming, the lock must be open during the entire programming process.

1. Select the submenu TIME.



2. Press the **ENTER** key.
 - ⇒ The currently set time will be displayed.



3. Use the **LEFT** or **RIGHT** key to select the current hour and enter a new time.
4. Press the **ENTER** key to confirm.
5. Use the **LEFT** or **RIGHT** arrow key to adjust the minutes.
6. Select "YES" in the "SAVE?" dialog by using the **LEFT** or **RIGHT** arrow key.
7. Press the **ENTER** key.

15.1.6.2 Setting the date

Authorization: Master code



The respective weekdays and leap years are automatically calculated with the internal calendar (calendar range: Jan-1-2000 ... Dec-31-2099).

1. Select the submenu DATE.



2. Press the **ENTER** key.
 - ⇒ The currently set date will be displayed.

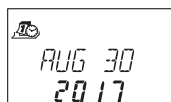

3. Use the **LEFT** or **RIGHT** key to select the current month.
4. Press the **ENTER** key to confirm and move to the day.
5. Use the **LEFT** or **RIGHT** key to select the day.
6. Press the **ENTER** key to confirm and move to the year.
7. Use the **LEFT** or **RIGHT** key to select the year.
8. Press the **ENTER** key to confirm.
9. Select "YES" in the "SAVE?" dialog by using the **LEFT** or **RIGHT** arrow key.
10. Press the **ENTER** key.
 - ⇒ The message **ACCEPTED** appears for a short time period and the input unit returns to the submenu DATE.

15.1.6.3 Setting the time format AM/PM

Authorization: Master code



With „AM/PM ON“ the time is displayed in 12 hour format (1:00 until 12:59).
 With „AM/PM OFF“ the time is displayed in 24 hour format (00:00 until 23:59).

1. Select submenu **AM/PM**.



2. Press the **ENTER** key.
 ⇒ The currently set time format will be displayed.



3. Select either **ON** or **OFF** by pressing the **LEFT** or **RIGHT** arrow key
4. Select "YES" in the "SAVE?" dialog by using the **LEFT** or **RIGHT** arrow key.
5. Press the **ENTER** key.

15.1.7 Menu PROG

15.1.7.1 Activating the Immediate Time Lock

With this function it is possible to activate a locking period with immediate effect. When the lock is closed it is not possible to open it for the set time period. The Immediate Time Lock is not related to time / date. It is not possible to bypass the Immediate Time Lock, unless the Master was set to "Master can override the Immediate Time Lock".



The maximum duration of an Immediate Time Lock is 144 hours. The duration of the Immediate Time Lock can be limited in the AS284-USBW or AS284-NETW programming software. Changing hours and minutes to 000:00 will deactivate the Immediate Time Lock.



The factory setting for Manager Codes "can activate Immediate Time Lock" is ON. The setting Manager Codes "can activate Immediate Time Lock" can be set in AS284-USB or AS284-NETW programming software.

The factory setting for User Codes "can activate Immediate Time Lock" is OFF. This setting User Codes "can activate Immediate Time Lock" can be set in AS284-USBW or AS284-NETW programming software.

1. Select the submenu **IMM-TL**.

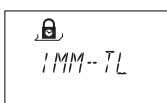

2. Press the **ENTER** key.

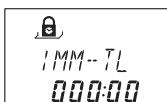

3. Use the **LEFT** or **RIGHT** arrow key to set the duration of time in hours and minutes to define the locking period of the Immediate Time Lock.
4. Select "YES" in the "SURE?" dialog by using the **LEFT** or **RIGHT** arrow key.
5. Press the **ENTER** key.

15.1.7.2 Configuring Weekly Locking Periods



Depending on the configuration of the lock, Weekly Locking Periods can last from 1 minute up to 6 days, 23 hours and 59 minutes.

It is possible to define up to 35 locking periods (with repetition). During these locking periods it is not possible to open the lock (for example outside business hours).

15.1.7.2.1 Adding a Weekly Locking Period



If the maximum of 35 defined locking periods is reached, no further entries are possible. The display does not react any more.



The entry of day and time depends on the AM/PM setting.
 If the time format is set to 12 hours (AM/PM On), the weekdays are numbered: Sunday = 1, Monday = 2 ... Saturday = 7.
 If the time format is set to 24 hours (AM/PM Off), the weekdays are numbered: Monday = 1, Tuesday = 2 ... Sunday = 7.

1. Select the submenu **WEEKLY**.



2. Press the **ENTER** key.
 ⇒ The count will be displayed.



3. Press the **ENTER** key to enter a new time period.
4. Use the **LEFT** or **RIGHT** arrow key to set the day and time for the starting point of the locking period.
5. Press the **ENTER** key to confirm the setting.
6. Use the **LEFT** or **RIGHT** arrow key to set the day and time for the endpoint of the locking period.



7. Select "YES" in the "SAVE?" dialog by using the **LEFT** or **RIGHT** arrow key.
8. Press the **ENTER** key.
9. Repeat steps 2 to 8 to define other locking periods or press the **INFO/ESC** key to exit the menu.

15.1.7.2.2 Changing an existing Weekly Locking Period



It must be possible to open the lock between 2 Weekly Locking Periods. Weekly Locking Periods are saved in a chronological order, starting with Monday.

1. Proceed as in the described sequence "Adding a Weekly Locking Period".
2. Instead of pressing the **ENTER** key to select a new time period, use the **RIGHT** or **LEFT** arrow key to select the Weekly Locking Period to be changed.
3. Press the **ENTER** key to confirm the selection.
4. Overwrite the Weekly Locking Period.

15.1.7.2.3 Deleting an existing Weekly Locking Period

1. Select the submenu WEEKLY.



2. Press the **ENTER** key.
 - ⇒ The count will be displayed.
3. Use the **RIGHT** or **LEFT** arrow key to select the starting point of the Weekly Locking Period to be deleted.



4. Press the **DEL** key.
5. Select "YES" in the "CLEAR?" dialog by using the **LEFT** or **RIGHT** arrow key.
6. Press the **ENTER** key to confirm the deletion.
 - ⇒ The count will be displayed.

15.1.7.3 Configuring Holiday Locking Periods

It is possible to define up to 22 date-related locking periods with this function. During these locking periods it is not possible to open the lock (for example holidays or public holidays).

15.1.7.3.1 Adding a Holiday Locking Period

Requirements:

- There must be a time gap of at least 1 day between 2 Holiday Locking Periods.
- It is only possible to configure 2 Holiday Locking Periods without time gaps, if 1 Holiday Locking Period is repetitive and the other one is non-repetitive.



If repetitive and non-repetitive Holiday Locking Periods are configured without time gaps, there will be a high risk of a lock-out.

If the maximum of 22 defined Holiday Locking Periods is reached, no further entries are possible. The display does not react any more.

1. Select the submenu **HOLIDAY**.



2. Press the **ENTER** key.
 - ⇒ The count will be displayed.

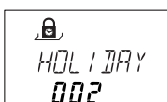

3. Press the **ENTER** key to define a new time period.
4. Use the **LEFT** or **RIGHT** arrow key to set the month, day and year for the starting point of the Holiday Locking Period.

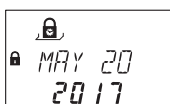

5. Press the **ENTER** key to confirm the settings.
6. Use the **LEFT** or **RIGHT** arrow key to set the month, day and year for the endpoint of the Holiday Locking Period.

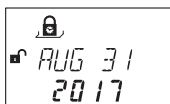

7. Select "YES" in the "SAVE?" dialog by using the **LEFT** or **RIGHT** arrow key.
8. Press the **ENTER** key.

15.1.7.3.2 Changing an existing Holiday Locking Period

1. Proceed as in the described sequence "Adding a Holiday Locking Period".
2. Instead of pressing the **ENTER** key to define a new time period, use the **RIGHT** or **LEFT** arrow key to select the Holiday Locking Period to be changed.
3. Overwrite the Holiday Locking Period.

15.1.7.3.3 Deleting an existing Holiday Locking Period

1. Select the submenu **HOLIDAY**.



2. Press the **ENTER** key.
3. Use the **RIGHT** or **LEFT** arrow key to select a starting point for the Holiday Locking Period to be deleted.

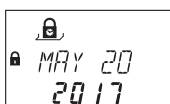

4. Press the **DEL** key.
5. Select "YES" in the "CLEAR" dialog by using the **LEFT** or **RIGHT** key .
6. Press the **ENTER** key to confirm the setting.

15.1.7.4 Configuring Time Locking Interruptions

It is possible to define up to 8 date-related Time Locking Interruptions. During these Time Locking Interruptions it is possible to open the lock by overriding an existing time locking period (for example Weekly Locking or Holiday Locking Period).

The set Time Locking Interruption will still be saved, even if the defined time and date have already elapsed.

15.1.7.4.1 Adding a Time Locking Interruption



The duration of a Time Locking Interruption is limited to 144 hours.

If the maximum of 8 defined Time Locking Interruptions is reached, no further entries are possible.

The display does not react any more.

1. Select the submenu **TL-INT**.

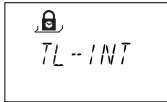

2. Press the **ENTER** key.
 - ⇒ The number of Time Locking Interruptions will be displayed.



3. Press the **ENTER** key to enter a new period for Time Locking Interruption.
4. Use the **LEFT** or **RIGHT** arrow key to set a month as starting point for the Time Locking Interruption.
5. Press the **ENTER** key to confirm the setting.
6. Repeat these steps to set the day and year.
7. Use the **LEFT** or **RIGHT** arrow key to set the hour for the starting point of Time Locking Interruption.
8. Press the **ENTER** key to confirm the setting.
9. Repeat these steps to set the minutes.



10. Use the **LEFT** or **RIGHT** arrow key to set the minutes for the duration of the Time Locking Interruption.
11. Press the **ENTER** key to confirm the setting.
12. Select "YES" in the "SAVE?" dialog by using the **LEFT** or **RIGHT** arrow key.
13. Press the **ENTER** key.

15.1.7.4.2 Changing an existing Time Locking Interruption

1. Proceed as in the described sequence "Adding a Time Locking Interruption".
2. Instead of pressing the **ENTER** key as in step 3, use the **RIGHT** or **LEFT** arrow key to select the Time Locking Interruption to be changed.
3. Overwrite the Time Locking Interruption.

15.1.7.4.3 Deleting an existing Time Locking Interruption

1. Select the menu **TL-INT**.

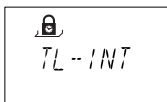

2. Press the **ENTER** key.
3. Use the **LEFT** or **RIGHT** arrow key to select a starting point for the period of the Time Locking Interruption to be deleted.



4. Press the **DEL** key.
5. Select "YES" in the "CLEAR?" dialog by using the **LEFT** or **RIGHT** arrow key.
6. Press the **ENTER** key to confirm the setting.

15.1.7.5 Configuring Time-Related Functions

It is possible to define up to 3 Time-Related Functions.
 Each Time-Related Function supports user group 1, 2 and 3.
 Optionally it can be defined for which days the Time-Related Function is to apply.

There are 7 different settings:

- 1 Start time
- 2 End time
- 3 Delay
- 4 Toggle Dual Mode
- 5 Code Denial
- 6 Partial Locking
- 7 Weekly

Time-Related Functions

	Valid for		
Time-Related Function 1	Master (only for delay)	Manager 1	Users 11 ... 19
Time-Related Function 2	-	Manager 2	Users 21 ... 29
Time-Related Function 3	-	Manager 3	Users 31 ... 39

15.1.7.5.1 Adding a Time-Related Function



If the maximum of 3 Time-Related Functions is reached, no further entries are possible.
 The display does not react any more.

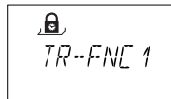

1. Select submenu **TR-FNC1**, **TR-FNC2** or **TR-FNC3**.
2. Press the **ENTER** key.

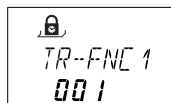

⇒ If any Time-Related Function has already been defined, a number higher than "000" will be displayed.

3. Press the **ENTER** key.
4. Use the **LEFT** or **RIGHT** arrow key to set the hour for the starting point of the Time-Related Function.



5. Press the **ENTER** key to confirm the setting.
6. Repeat these steps to set the minutes.
7. Use the **LEFT** or **RIGHT** arrow key to set the hour for the endpoint of the Time-Related Function.



8. Press the **ENTER** key to confirm the setting.
9. Repeat these steps to set the minutes.



10. If an opening delay is set, select "ON" by using the **LEFT** or **RIGHT** arrow key.
11. Press the **ENTER** key to confirm the setting.



12. Use the **LEFT** or **RIGHT** arrow key to set the minute for the delay.



It is only possible to define minutes for a Time Delay.
It is not possible to define seconds.

The duration of a Time Delay is limited to a maximum of 99 minutes.

13. Press the **ENTER** key to confirm the setting.

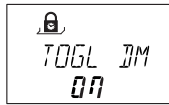

- ⇒ If "Toggle Dual Mode" is to be set, select "ON" by using the **LEFT** or **RIGHT** arrow key.
- ⇒ If Dual Mode is configured in the menu **MISC**, Dual Mode will switch off during the defined time period.
- ⇒ If Dual Mode is switched off, Dual Mode will switch on during the defined time period.

14. Press the **ENTER** key to confirm the setting.



15. If the user group needs to be deactivated (Code Denial), select "ON" by using the **LEFT** or **RIGHT** arrow key.
16. Press the **ENTER** key to confirm the setting.
17. If "Partial Locking" is to be set, select "ON" by using the **LEFT** or **RIGHT** arrow key.



18. Press the **ENTER** key to confirm the setting.



19. If the Time-Related Function is not to be used for all days of a week, switch **WEEKLY** to "ON" by using the **LEFT** or **RIGHT** arrow key.
20. Press the **ENTER** key to confirm the setting.
21. Switch each day to "**ON**" for which the Time-Related Function is to apply.
22. Press the **ENTER** key to confirm the setting.
23. Move to the next day and repeat the procedure for each day.

24. Select "YES" in the "SAVE?" dialog by using the **LEFT** or **RIGHT** arrow key.
25. Press the **ENTER** key to confirm the settings.

15.1.7.5.2 Changing an existing Time-Related Function

1. Proceed as in the described sequence "Adding a Time-Related Function".
2. Instead of pressing the **ENTER** key as in step 3, use the **RIGHT** or **LEFT** arrow key to select a Time-Related Function and its parameters.
3. Overwrite the Time-Related Function.

15.1.7.5.3 Deleting an existing Time-Related Function

1. Select the submenu **TR-FNC1**, **TR-FNC2** or **TR-FNC3**.

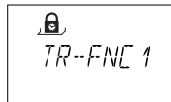

2. Press the **ENTER** key.



3. Use the **RIGHT** key to check the settings of all activated Time-Related Functions.
4. Select the desired Time-Related Function to be deleted.
5. Press the **DEL** key.
6. Select "YES" in the "CLEAR" dialog by using the **LEFT** or **RIGHT** arrow key.
7. Press the **ENTER** key to confirm the setting.

15.1.8 Menu DELAY

15.1.8.1 Setting and deactivating Time Delays

Submenu DELAY 1 ... 4

Once a valid code is entered, the lock will only open after the configured Time Delay has elapsed.

It is possible to set a Time Delay for each user group between 0 (deactivated, no time delay) and 99 minutes.



Ex factory Time Delays are deactivated (set to 00:00).

The maximum configurable value of a Time Delay must be shorter than the shortest time gap between any 2 Weekly Locking Periods.

By entering a Courier Code it is possible to open the lock without a time delay.

Time Delays

	Valid for		
Time Delay 1	Master	Manager 1	Users 11 ... 19
Time Delay 2	-	Manager 2	Users 21 ... 29
Time Delay 3	-	Manager 3	Users 31 ... 39
Time Delay 4	-	Manager 4	Users 41 ... 49

1. Select the submenu **DELAY 1**, **DELAY 2**, **DELAY 3** or **DELAY 4**.



2. Press the **ENTER** key.
 - ⇒ The currently set Time Delay will be displayed.



3. Use the **LEFT** or **RIGHT** arrow key to set the defined Time Delay.
4. Press the **ENTER** key.
5. Select "YES" in the "SAVE?" dialog by using the **LEFT** or **RIGHT** arrow key.
6. Press the **ENTER** key to confirm the setting.



It is possible to configure a Duress Time Delay for each user group via AS284-USBW or AS284-NETW programming software.

In contrast to normal Time Delays it is possible to set a shorter or longer time period for the Duress Time Delay.

It is also possible to suppress Time Delays with an external signal. This option allows to open the lock without a Time Delay (for example to empty ATMs).

Duress Time Delays

	Valid for		
Duress Time Delay 1	Master	Manager 1	Users 11 ... 19
Duress Time Delay 2	-	Manager 2	Users 21 ... 29
Duress Time Delay 3	-	Manager 3	Users 31 ... 39
Duress Time Delay 4	-	Manager 4	Users 41 ... 49

15.1.8.2 Configuring the Confirmation Window

Submenu CNF WIN

To prevent the lock from opening automatically after a defined Time Delay has elapsed, a Confirmation Window will start in which a valid code must be entered within a limited time frame.



If Manager Codes were defined via AS284-USBW or AS284-NETW programming software as "Manager can change Confirmation Window", it is possible to change this setting with Manager Codes.



Ex factory the Confirmation Window is set to 5 minutes.

The minimum value is 1 minute.

The maximum configurable value of a Time Delay must be shorter than the shortest time gap between any 2 Weekly Locking Periods.

The set value for the Confirmation Window is also used for skipping a Time Delay with the Courier Code, if the function "Courier Code does not open, but skips Time Delay" is activated.

It is not possible to deactivate the Confirmation Window.

1. Select the submenu **CNF WIN**.

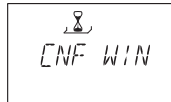

2. Press the **ENTER** key.
⇒ The currently set confirmation time will be displayed.



3. Use the **LEFT** or **RIGHT** arrow key to set the defined confirmation time (setting from 1:00 to 99:00 minutes).
4. Press the **ENTER** key.
5. Select "YES" in the "SAVE?" dialog by using the **LEFT** or **RIGHT** arrow key.
6. Press the **ENTER** key to confirm the settings.

15.1.8.3 Configuring NRTD

Submenu NRTD-HM



Ex factory NRTD is set to 0 minutes.

It is possible to override NRTD with a code generated in OTM (AS274). This function must be activated by AS284-USBW programming software.

When closing the lock, it is not possible to open the lock during the set duration for NRTD.

1. Select the menu **NRTD-HM**.

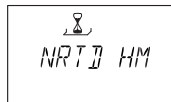

2. Press the **ENTER** key.
⇒ The currently set NRTD will be displayed (hours:minutes).



3. Use the **LEFT** or **RIGHT** arrow key to set the defined NRTD (setting from 00:00 min. to 99:00 h).
4. Press the **ENTER** key.
5. Select "YES" in the "SAVE?" dialog by using the **LEFT** or **RIGHT** arrow key.
6. Press the **ENTER** key to confirm the setting.

15.1.8.4 Configuring the Beeper Time Delay for Door Opening Alarm

Submenu D-ALARM

Authorization: Master Code



Factory setting for the Beeper Time Delay for Door Opening Alarm is OFF. Factory setting for the Beeper Time Delay for Door Opening Alarm is 3 minutes.

Once the door is open, the lock will notify the user when the door opening time has elapsed.

1. Select the submenu **D-ALARM**.

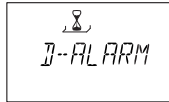

2. Press the **ENTER** key.
 - ⇒ The currently set beeper Time Delay for Door Opening Alarm will be displayed (minutes:seconds).



3. Use the **LEFT** or **RIGHT** arrow key to set the defined beeper Time Delay for Door Opening Alarm (setting from 00:00 to 99.00 minutes).
4. Press the **ENTER** key.
5. Select "YES" in the "SAVE?" dialog by using the **LEFT** or **RIGHT** arrow key.
6. Press the **ENTER** key to confirm the settings.

15.1.8.5 Configuring the window for a second code in Dual Mode

Submenu **DUAL bank**



Ex factory the opening window is set to 1 minute.

In Dual Mode a second opening code must be entered within a limited time period.

1. Select the submenu **DUAL bank**.



2. Press the **ENTER** key.
 - ⇒ The currently set time will be displayed (minutes:seconds).



3. Use the **LEFT** or **RIGHT** arrow key to set the desired time to enter a second opening code (setting from 00:15 to 02:30).
4. Press the **ENTER** key.
5. Press **ENTER** key.
6. Select "YES" in the "SAVE?" dialog by using the **LEFT** or **RIGHT** arrow key.
7. Press the **ENTER** key to confirm the setting.

15.1.8.6 Configuring Bolt Open Time

Submenu **BLT OPN bank**

Authorization: Master Code



Ex factory the Bolt Open Time is set to 6 seconds.

When the lock is opened, it will close automatically when the Bolt Open Time has elapsed. It is possible to prevent the lock from closing automatically either when a door contact is connected or the bolt work is kept open..

1. Select the submenu **BLT OPN bank**.



2. Press the **ENTER** key.
 - ⇒ The current Bolt Open Time will be displayed (minutes:seconds).



3. Use the **LEFT** or **RIGHT** arrow key to set the desired Bolt Open Time (setting from 00:06 to 99:00 minutes).
4. Press the **ENTER** key.
5. Select "YES" in the "SAVE?" dialog by using the **LEFT** or **RIGHT** arrow key.
6. Press the **ENTER** key to confirm the setting.

15.1.9 Menu CODE

15.1.9.1 Authorization of codes

Each of the 4 code types (Master, Manager, User and Courier) has a different authorization.

There are 3 options to make changes:

- To activate (A) a code
- To modify (M) a code or
- to delete (D) codes.

	Changes to be made by owner of			
	Master Code	Resp. Manager Code	Resp. User Codes	Courier Code
Master Code	M	-	-	-
Manager Code	A M D	M	-	-
User Code	A M D	A M D	M	-
Courier Code	A M D	-	-	M

15.1.9.2 Changing the Master Code

Submenu MASTER

Authorization: Master Code

1. Select the submenu **MASTER**.



2. Press the **ENTER** key.



3. Select "YES" by using the **LEFT** or **RIGHT** arrow key.
4. Press the **ENTER** key.
5. Use the **NUMERIC** keys to enter a new code.

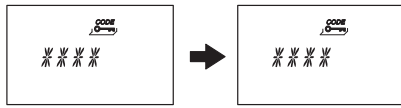

6. Press the **ENTER** key to confirm the setting.
7. **CONFIRM** will be displayed shortly to ask the user to enter the same code to confirm the setting.
8. USE the **NUMERIC** keys to enter the same code again.
9. Press the **ENTER** key to confirm the setting.

15.1.9.3 Setting Manager Codes

Submenu MANAGER

Authorization: Master Code

1. Select the submenu **MANAGER**.



2. Press the **ENTER** key.



It is only required to select the submenu **Manager**, if the Programming Mode was entered with Master or Manager Code.

3. Use the **LEFT** or **RIGHT** arrow key to select the Manager Code to be set.
 - ⇒ Manager Codes, which have already been activated, will be displayed as "USED", not activated codes will be displayed as "- - - -").



4. Press the **ENTER** key.
5. Use the **NUMERIC** keys to enter a new code.

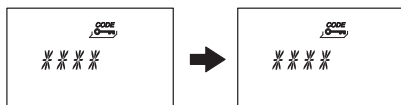

6. Press the **ENTER** key to confirm the setting.
 - ⇒ **CONFIRM** will be displayed shortly to ask the user to enter the same code again.
7. Use the **NUMERIC** keys to enter the same code again.
8. Press the **ENTER** key to confirm the setting.

15.1.9.4 Setting User Codes

Submenu USER

Authorization: Master Code or respective Manager Code

1. Select the submenu **USER**.



2. Press the **ENTER** key.



It is only required to select the submenu **User**, if the Programming Mode was entered with Master or Manager Code.

3. Use the **LEFT** or **RIGHT** arrow key to select the User Code to be changed.
 - ⇒ User Codes, which have already been activated, will be displayed as "USED", not activated codes will be displayed as "- - - -".



4. Press the **ENTER** key.
5. Use the **NUMERIC** keys to enter a new code.

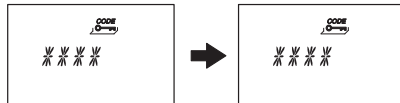

6. Press the **ENTER** key to confirm the setting.
 - ⇒ "CONFIRM" will be displayed shortly and you are asked to enter the same code again.
7. Use the **NUMERIC** keys to enter the same code again.
8. Press the **ENTER** key to confirm.

15.1.9.5 Setting the Courier Code

Submenu COURIER

Authorization: Master Code

1. When entering with the Courier Code, start with step 5.
2. Select the submenu **COURIER**.



3. Press the **ENTER** key.



⇒ An activated Courier Code will be displayed as "USED".
An deactivated Courier Code will be displayed as "- - - -".

4. Press the **ENTER** key.
5. Use the **NUMERIC** keys to enter a new code.



6. Press the **ENTER** key to confirm the setting.
 - ⇒ "CONFIRM" will be displayed shortly to ask the user to enter the same code again.
7. Use the **NUMERIC** keys to enter the same code.
8. Press the **ENTER** key to confirm the setting.

15.1.9.6 Changing codes

Authorization: Own code or a higher code

Steps 1 - 6 must only be carried out, if the Programming Mode was entered with a higher code than the one to be changed.

1. Select the menu **CODE**.



2. Press the **ENTER** key.
3. Use the **LEFT** or **RIGHT** arrow key to select the code (for example User Code) to be changed.



4. Press the **ENTER** key.
5. Use the **LEFT** or **RIGHT** arrow key to select the code (for example User Code 11) to be changed.
6. Press the **ENTER** key.

⇒ The user is asked either to change or not to change the code.



7. Select "YES" by using the **LEFT** or **RIGHT** arrow key.
 - ⇒ Press the **ENTER** key to confirm the changed code.
8. Use the **NUMERIC** keys to enter a new code.

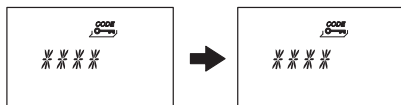

9. Press the **ENTER** key to confirm the changed code.
 - ⇒ "CONFIRM" will be displayed shortly to ask the user to enter the same code again.
10. Use the **NUMERIC** keys to enter the same code.
11. Press the **ENTER** key to confirm the setting.

15.1.9.7 Deleting a code

Authorization: A higher code than the own code



The Master Code cannot be deleted.

When a Manager Code is deleted, the respective group of User Codes remains unchanged.

1. Select the menu **CODE**.



2. Press the **ENTER** key.
3. Use the **LEFT** or **RIGHT** arrow key to select the code type (for example "user") to be changed.
4. Press the **ENTER** key.
5. Use the **LEFT** or **RIGHT** arrow key to select the code (for example "User Code 11") to be changed.



6. Press the **DEL** key.
 - ⇒ The user is asked either to delete or not to delete the code.



7. Select "YES" by using the **LEFT** or **RIGHT** arrow key.
8. Press the **ENTER** key to confirm the deletion.

15.1.9.8 Resetting the electronic safe lock

Submenu **SHELVE**



With the Shelve Function it is possible to reset the electronic safe lock to factory settings.

All codes will be deleted and all parameters such as Time Delay, Time Locking Function, Dual Mode will be set to factory settings.

Time/date, opening counter and audit trail remain unchanged.



Keep in mind that all data is lost when the electronic safe lock will be reset to factory settings. It is recommended to save all data via AS284-USBW or AS284-NETW programming software prior to shelving.

Keep in mind that codes cannot be saved.

Authorization: Master Code

1. Select the submenu **SHELVE**.



2. Press the **ENTER** key.



- ⇒ The user is asked either to reset or not to reset all data to factory settings.
3. Select "YES" by using the **LEFT** or **RIGHT** arrow key.
 4. Press **ENTER** key.
 - ⇒ All data is reset to factory settings.

15.1.10 Menu MISC

15.1.10.1 Setting the Display Language

By default the display language is English.

It is possible to set the display language either with the input unit or via AS284-USB or AS284-NETW programming software.



It is possible to change the display language in the information menu without entering an access code.

Authorization: Master Code or any Manager Code

1. Select the submenu **LANG**.



2. Press the **ENTER** key.
 - ⇒ The currently set display language will be displayed.

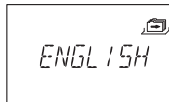

3. Use the **LEFT** or **RIGHT** arrow key to select the desired display language.
4. Press the **ENTER** key to confirm the selected display language.
5. Select "YES" in the "SAVE?" dialog by using the **LEFT** or **RIGHT** arrow key.
6. Press the **ENTER** key to confirm the setting.

15.1.10.2 Managing the safe lock system with the Device Manager



The range of functions of the master lock differs from the functions of the slave locks. The Device Manager of a slave lock only displays 2 connected devices: the input unit and the respective slave lock. The slave lock is only able to check the type, version, the last 8 digits of the serial number and a customized 5-digit number of the respective slave lock. A bus system test of the respective slave lock and the input unit can be conducted.

The Device Manager comprises several functions:

- Checking the number of connected devices (locks, eBoxes and input units)
- Conducting a simple bus system test
- Moving selected locks to another lock position

Authorization: Master Code

1. Select the Submenu **DEVICE** on the master lock.

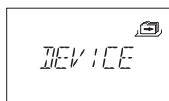

2. Press the **ENTER** key.

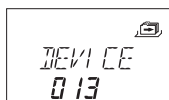

⇒ The Device Manager displays the number of all connected devices of the safe lock system.

3. Press the **Right** arrow key to select the desired device.
 - ⇒ The selected devices will be displayed.



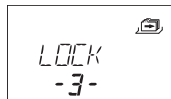
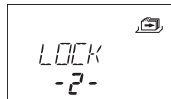

⇒ Up to 10 connected slave locks will be displayed.

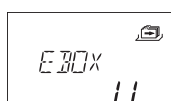
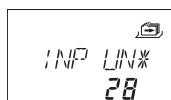
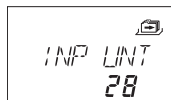

4. Press the **ENTER** key to confirm the setting.

15.1.10.2.1 Entering the lock parameters and testing the bus system

There are 2 options:

- Checking the lock parameters by selecting a desired lock from the lock list
- Conducting a bus system test of the safe lock system



Any counter number over 040 is a good result of a bus system test. There is a connection to the tested device.

If the counter numbers are between 000 and 040 it is recommended to check the wiring.



The Device Manager of the master lock displays the number of all connected devices of the safe lock system.

The Device Manager of the slave locks displays the number 002 (the respective slave lock and input unit).

Authorization: Master Code

1. Select the submenu **DEVICE**.

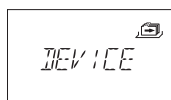

2. Press the **ENTER** key.

⇒ The Device Manager displays the number of all connected devices of the safe lock system.

3. Press the **Right** arrow key to select the desired device.

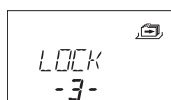

⇒ The selected device will be displayed.

4. Press the **ENTER** key.

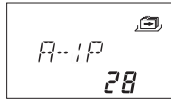

⇒ The safe lock type and the version number will be displayed.

5. Press the **Right** arrow key.

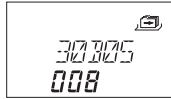

⇒ The last 8 digits of the serial number of the selected lock will be displayed.

6. Press the **Right** arrow key.



⇒ The customized 5-digit number will be displayed. By default, these are the last 5 digits of the serial number.

7. Press the **Right** arrow key.

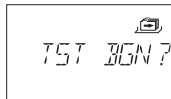

⇒ A bus system test of the selected device can be started.

8. Press the **ENTER** key.

⇒ The bus system test starts.
The counter starts from 000 and can count up to the maximum value of 360.

⇒ The test result will be displayed.

15.1.10.2.2 Moving the selected lock

Authorization: Master Code

1. Select the submenu **DEVICE** on the master lock.

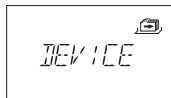

2. Press the **ENTER** key.



⇒ The Device Manager displays the number of all connected devices of the safe lock system.

3. Press the **Right** arrow key to select the desired device.

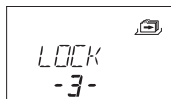

⇒ The selected device will be displayed.

4. Press the **ENTER** key.

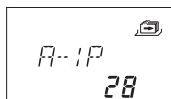

⇒ The safe lock type and the version number will be displayed.

5. Press the **Right** arrow key.

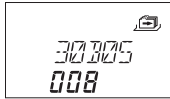

⇒ The last 8 digits of the serial number of the selected lock will be displayed.

6. Press the **Right** arrow key.

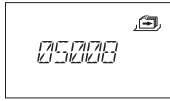

⇒ The customized 5-digit number will be displayed.
These are the last 5 digits of the serial number.

7. Press the **Right** arrow key.

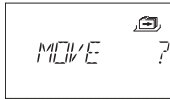

⇒ The selected lock -3- can be moved to another lock position.

8. Press the **ENTER** key.

⇒ "MOVE TO" and the current lock position will be displayed.

9. Use the **LEFT** or **RIGHT** arrow key to select the new lock position.

10. Press the **ENTER** key to confirm the new lock position.

11. Select "YES" in the "SAVE?" dialog by using the **LEFT** or **RIGHT** arrow key.

12. Press the **ENTER** key to confirm the setting.

15.1.10.3 Activating or deactivating Remote Disabling

It is possible to deactivate the opening of a closed lock with an external signal. This function is used when an additional identification is required (for example badge, biometrics) or when it is necessary to prevent the lock from opening (for example when the alarm system is activated).



It is only possible to configure 1 function at a time via AS284-USBW or AS284-NETW programming software either Remote Disabling or cancel Non Return Time Delay (NRTD). Both functions cannot be configured at the same time.



One of the inputs must be configured with AS284-USBW or AS284-NETW programming software to use the Remote Disabling function.

Remote Disabling is not activated when the lock is open. The lock can be operated normally.

It is possible to override the Remote Disabling function with the Master code to avoid a total lock-out if the external signal fails.

Authorization: Master Code

1. Select the submenu **RMT-DIS**.

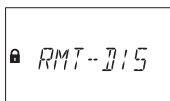

2. Press the **ENTER** key.

⇒ **RMT-DIS** will be displayed.

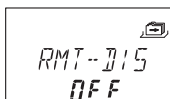

3. Select either **ON** or **OFF** by using the **LEFT** or **RIGHT** arrow key.
4. Press the **ENTER** key to confirm the setting.
5. Select "YES" in the "SAVE?" dialog by using the **LEFT** or **RIGHT** arrow key.
6. Press the **ENTER** key to confirm the setting.

15.1.10.4 Setting the Beeper Volume

Authorization: Master Code

1. Select the submenu **VOLUME**.



2. Press the **ENTER** key.
 - ⇒ The current volume will be displayed.



3. Use the **LEFT** or **RIGHT** arrow key to set the desired volume (000 for off, 001 for low and 002 for high volume).
4. Press the **ENTER** key to confirm the setting.
5. Select "YES" in the "SAVE?" dialog by using the **LEFT** or **RIGHT** arrow key.
6. Press the **ENTER** key to confirm the setting.

15.1.10.5 Activating or deactivating Open Beeper

The Open Beeper function is used to notify the user if for example a safe door is open or the bolt work is unlocked.
10 short beep signals sound every 20 seconds.

Authorization: Master Code

1. Select the submenu **OPEN beep**.



2. Press the **ENTER** key.
 - ⇒ The message is displayed if the beeper is activated or deactivated.



3. Select either **ON** or **OFF** by using the **LEFT** or **RIGHT** arrow key.
4. Press the **ENTER** key to confirm the setting.
5. Select "YES" in the "SAVE?" dialog by using the **LEFT** or **RIGHT** arrow key.
6. Press the **ENTER** key to confirm the setting.

15.1.10.6 Activating or deactivating the Beeper for Confirmation Window

This setting defines if the Confirmation Window is activated and waiting for a confirmation code to be generated after the Time Delay has elapsed.
The elapsed time period is indicated with 3 beep signals every 60 seconds.

Authorization: Master Code

1. Select the submenu **CNF WIN beep**.



2. Press the **ENTER** key.
 - ⇒ The message is displayed if the beeper is activated or deactivated.



3. Select either **ON** or **OFF** by using the **LEFT** or **RIGHT** arrow key.
4. Press the **ENTER** key to confirm the setting.
5. Select "YES" in the "SAVE?" dialog by using the **LEFT** or **RIGHT** arrow key.
6. Press the **ENTER** key to confirm the setting.

15.1.10.7 Activating or deactivating the Beeper Time Delay

This setting defines if an opening Time Delay is indicated with 1 beep signal every 60 seconds.

Authorization: Master Code

1. Select the submenu **DELAY beep**.



2. Press the **ENTER** key.
 - ⇒ The message is displayed if the beeper is activated or deactivated.



3. Select either **ON** or **OFF** by using the **LEFT** or **RIGHT** arrow key.
4. Press the **ENTER** key to confirm the setting.
5. Select "YES" in the "SAVE?" dialog by using the **LEFT** or **RIGHT** arrow key.
6. Press the **ENTER** key to confirm the setting.

15.1.10.8 Activating or deactivating the Beeper for Door Opening Alarm

This setting activates or deactivates the Beeper for Door Opening Alarm. If this setting is activated, a beep signal sounds repeatedly in short intervals after the opening time delay has elapsed.

Authorization: Master Code

1. Select the submenu **D-ALARM beep**.
2. Press the **ENTER** key.
 - ⇒ The message is displayed if the beeper is activated or deactivated.



3. Select either **ON** or **OFF** by using the **LEFT** or **RIGHT** arrow key.
4. Press the **ENTER** key to confirm the setting.
5. Select "YES" in the "SAVE?" dialog by using the **LEFT** or **RIGHT** arrow key.
6. Press the **ENTER** key to confirm the setting.

15.1.10.9 Activating or deactivating Waiting Time

Authorization: Master Code

1. Select the submenu **WAIT info**.



2. Press the **ENTER** key.
 - ⇒ The message **WAIT** will be displayed.



3. Select either **ON** or **OFF** by using the **LEFT** or **RIGHT** arrow key.
4. Press the **ENTER** key to confirm the setting.
5. Select "YES" in the "SAVE?" dialog by using the **LEFT** or **RIGHT** arrow key.
6. Press the **ENTER** key to confirm the setting.

15.1.10.10 Activating or deactivating Language

This function defines which menu language is available.

Authorization: Master Code

1. Select the submenu **LANG info**.



2. Press the **ENTER** key.
3. Select either **ON** or **OFF** by using the **LEFT** or **RIGHT** arrow key.
4. Press the **ENTER** key to move to the next language.
5. After having defined the "last" language, select "YES" in the "SAVE?" dialog by using the **LEFT** or **RIGHT** arrow key.
6. Press the **ENTER** key to confirm the setting.

15.1.10.11 Setting the Lock Info

Authorization: Master Code

With the function Lock Info it is either possible to display the lock position (LOCK -1-) of the safe lock system or the customized 5-digit number. By default, these are the last 5 digits of the serial number.

1. Select the submenu **LOCK INFO** on the master lock.



2. Press the **ENTER** key.
 - ⇒ The message LOCK INFO will be displayed.
3. Select **OFF** by using the **RIGHT** arrow key to display the lock position (LOCK -1-).



4. Press the **ENTER** key.
5. Select "YES" in the "SAVE?" dialog by using the **LEFT** or **RIGHT** arrow key.
6. Press the **ENTER** key to confirm the setting.

15.1.10.12 Activating or deactivating Code Denial

With a higher code it is possible to deny access to a selected number of lower codes. An example for Code Denial is "off duty shifts". In this case a selected number of users is locked out during a defined time period and re-assigned when starting to work.

It is also possible to deny access to a defined user group (with or without the respective Manager Code).

Authorization: Master Code or any Manager Code

1. Select the submenu **CDE DEN bank**.



2. Press the **ENTER** key.
 - ⇒ The Code Denial status of the user group 1 will be displayed.



3. Use the **LEFT** or **RIGHT** arrow key to select a user group or manager.
4. Press the **ENTER** key to confirm the setting.



5. Use the **LEFT** or **RIGHT** arrow key to activate (**CDE DEN ON**, access denied) or deactivate (**CDE DEN OFF**, access allowed) the Code Denial for the selected user group or manager.
6. Press the **ENTER** key to confirm the setting.
7. Repeat steps 2 to 5 for the selected user groups and managers.

15.1.10.13 Activating or deactivating the Duress Code Function

Submenu **DURESS** bank



After recognizing a duress, the output will change from sleep mode to operating mode. The output remains as long in operating mode (indicator for a duress) as a valid code without information of a duress is entered. The lock opens. The output only goes back to sleep mode after lock opening.



It is possible to set the duration of a duress time delay (a longer or shorter time period) irrespective from a time delay.

If the lock is connected to an external alarm system, a silent duress alarm will be activated when a Duress Code is entered.

The alarm signal is not perceptible for the aggressor.

If the Duress Code function is activated, duress codes will be recognized.

If the lock is opened with a Duress Code, the defined Duress Time Delay will start.

Authorization: Master Code

1. Select the submenu **DURESS** bank.



2. Press the **ENTER** key.

- ⇒ The currently set status of the Duress Code will be displayed.
By default the Duress Code is set to off.



3. Use the **LEFT** or **RIGHT** arrow key to activate (**DURESS ON**) or deactivate (**DURESS OFF**) the Duress Code.
4. Press the **ENTER** key to confirm the setting.

15.1.10.14 Activating or deactivating Dual Mode

It is possible to configure the lock in a way that 2 codes are required for lock opening. Dual Mode is applied when only 2 persons are authorized to open the lock.

Authorization: Master Code

1. Select the submenu **DUAL bank**.



2. Press the **ENTER** key.
 - ⇒ The currently set status of the Dual Mode will be displayed.
By default Dual Mode is set to off.



3. Use the **LEFT** or **RIGHT** arrow key to activate (**DUAL ON**) or deactivate (**DUAL OFF**) the Dual Mode.
4. Press the **ENTER** key to confirm the setting.

15.1.10.15 Activating or deactivating One Shot Codes



When opening the lock with the Master Code, the code remains unchanged (no automatic deletion).

When opening the lock with the Manager Code 40, the code remains unchanged (no automatic deletion).

When opening the lock with a One Shot Code of user group 4, the code remains unchanged, if the Time Delay of user group 1 is set to the value "0" and the One Shot Code is confirmed by either the Master Code, 1 code of user group 1 or the Courier Code.

This function defines whether codes of user group 4 will be used as One Shot Codes. If this function is activated, the defined codes of user group 4 are only valid for 1 single opening.

Authorization: Master Code

1. Select the submenu **ONE SC4 bank**.

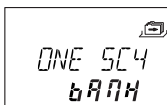

2. Press the **ENTER** key.
 - ⇒ The message is displayed If One Shot Codes are activated (**ON**) or deactivated (**OFF**).

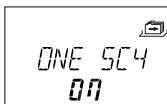

3. Select either **ON** or **OFF** by using the **LEFT** or **RIGHT** arrow key.
4. Press the **ENTER** key to confirm the setting.
5. Select "YES" in the "SAVE?" dialog by using the **LEFT** or **RIGHT** arrow key.
6. Press the **ENTER** key to confirm the setting.

15.1.10.16 Setting the Freeze function

15.1.10.16.1 Setting Freeze Off

The lock with the lowest serial number will be lock -1- (the master lock). When the function Freeze Off is activated, further devices (locks, eBoxes or input units) will be searched and connected automatically to the lock list.

When the eBox is connected to the safe lock system, the eBox will be automatically paired with lock -1-.

If a further eBox is connected to the safe lock system, the lock ignores the inputs of the eBox. When entering the Device Manager, the respective eBox is marked with an exclamation mark. With each power cycle the automatic pairing will be newly realized.



If more than 15 locks are connected to the safe lock system, the error message ERROR -16- will be displayed.

Authorization: Master Code

1. Select the submenu **FREEZE** on the master lock.

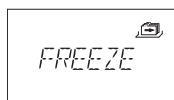

2. Press the **ENTER** key.
3. Select **OFF** by using the **LEFT** or **RIGHT** arrow key.



4. Press the **ENTER** key to confirm the setting.
5. Select "YES" in the "SAVE?" dialog by using the **LEFT** or **RIGHT** arrow key.
6. Press the **ENTER** key to confirm the setting.

15.1.10.16.2 Setting Freeze On



To guarantee that the selected lock remains lock -1- (master lock), it is possible to set the function Freeze for a short moment to ON and then switch to Freeze OFF. The selected lock will be set as the master lock and even after a power interruption remains the master lock. Locks with lower serial numbers than the master lock will be added to the lock list as slave locks.

Lock -1- is the master lock. When the function Freeze ON is activated, no further locks or eBoxes will be added to the lock list. The error message ERROR -16- will be displayed when a new lock is added.

A paired eBox will remain paired even after a power interruption. If a further eBox is connected, this eBox will not be paired with lock -1-.

The lock -1- ignores the inputs of the further eBox. When calling the Device Manager, this eBox is marked with an exclamation mark.

Authorization: Master Code

1. Select the submenu **FREEZE**.

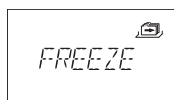

2. Press the **ENTER** key.

3. Select **ON** by using the **LEFT** or **RIGHT** arrow key.



4. Press the **ENTER** key to confirm the setting.
5. Select "YES" in the "SAVE?" dialog by using the **LEFT** or **RIGHT** arrow key.
6. Press the **ENTER** key to confirm the setting.

16 Operation

16.1 Code entry



It is possible to distract a potential observer's attention from memorizing a code during code entry.

Only the first 7 and the last entered digit is considered as code.

Requirements:

To distract a potential observer's attention from memorizing a code, the following procedure must be carried out:

1. Enter at least the first 7 digits and continue adding any possible number combination.
2. Enter the last digit of the code, for example **00123458921031 ... 256**.
3. Press the **ENTER** key.

Codes are entered in 2 groups of 4 digits.

The following procedure is carried out to open the lock or to enter the Programming Mode:

1. If necessary, press any key to wake up the display.
 - ⇒ The lock status appears, for example "LOCKED".
2. Enter the code, for example 11123456 by using the **NUMERIC** keys
 - ⇒ For every entered digit an asterisk appears.

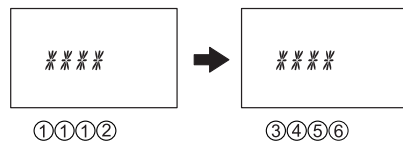

3. Press the **ENTER** key to confirm the code.

16.2 Lock opening procedure

The desired lock must be selected with the **LEFT** or **RIGHT** arrow key.

It is not possible to open the lock during the following conditions:

- Penalty after wrong trials
- During active locking periods (Immediate Time Lock, Weekly or Holiday Locking Periods)
- When the battery compartment is open
- When Remote Disabling is in process
- During an active connection with the programming software
- During NRTD



The opening procedure is valid for the activated functions Dual Mode and Time Delay. If neither Dual Mode nor Time Delay are set, the lock will open sooner.

If no key has been pressed for 1 minute, the display switches off automatically.

1. If necessary, press any key to wake up the display.
 - ⇒ The lock status is displayed.



2. Enter a code, for example 11123456 by using the **NUMERIC** keys.
 - ⇒ For every entered digit an asterisk appears.

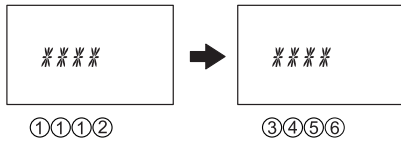

3. Press the **ENTER** key to confirm the code.
4. If the input unit is set to Dual Mode, a second code must be entered.

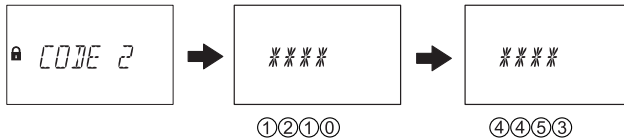

5. Press the **ENTER** key to confirm the code.
6. If an opening code with Time Delay was defined, the window for Opening Time Delay appears and the timer starts counting the set Time Delay.
 - ⇒ The remaining time will be displayed.
 - ⇒ Every 60 seconds a beep signal sounds while the Time Delay is counted. If the timer has elapsed, another beep signal indicates the end of the Opening Time Delay.

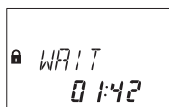

7. After the Opening Time Delay has elapsed, the Confirmation Window appears. The timer starts counting the set confirmation time. The remaining time for lock opening must be confirmed.

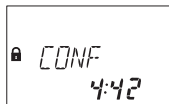

8. Enter the opening code.

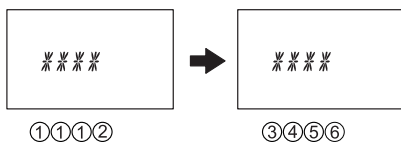

9. Press the **ENTER** key to confirm the code.
10. If the input unit is set to Dual Mode, a second code must be entered.

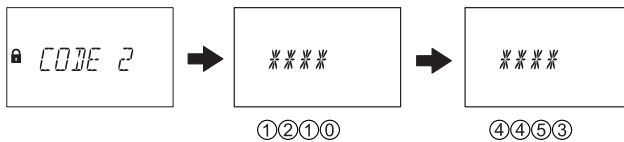

11. Press the **ENTER** key to confirm the code.
 - ⇒ The lock opens.



12. Open the safe.
 - ⇒ If desired, continue in Programming Mode.

16.3 Lock closing procedure



The lock closes automatically when the bolt work is locked.

Depending on the safe design, there are additional factors which have an impact on the closing procedure.

17 Troubleshooting

17.1 Status messages on LCD



If various causes lead to more than 1 error message REFUSED xx, the number of error messages will be summed up.

Example: REFUSED 12 = REFUSED 04 + REFUSED 08
 REFUSED 50 = REFUSED 02 + REFUSED 16 + REFUSED 32

Status message on LCD	Cause	Solution	Menu	Submenu
BAT-CMP OPEN	Battery compartment was opened.	1. Make sure that the battery compartment is closed. 2. Make sure that nobody manipulated the input unit. 3. Enter the Master, any Manager or a User Code with special function (Battery Code) to delete the status message.	n/a	n/a
LINE OFF	The connection between lock and input unit is temporarily interrupted.	1. Wait until the lock is in sleep mode; wake up the lock by pressing the info key. 2. If the message does not disappear automatically, remove the batteries and put the batteries in the battery compartment again. 3. If the message does not disappear automatically, disconnect the connecting cable. Make sure that the connecting cable is not damaged. If necessary, replace it. 4. Reconnect the connecting cable. Make sure that the connecting cable is connected correctly. 5. If the message does not disappear automatically, make sure that new batteries were put in the battery compartment. 6. If the message still does not disappear, call the vendor for technical support.	n/a	n/a
ID ERROR	ID for Master Code is not 00	Make sure that the first 2 digits of the code reflect the ID.	CODE	MASTER
	ID for Manager Codes is not 10, 20, 30 or 40			MANAGER
	ID for User Codes is not 11 ... 19, 21 ... 29, 31 ... 39, 41 ... 49			USER
	ID for Courier Code is not 90			COURIER
REFUSED	Code change: The entered code does not match with the code entered before.	Make sure to enter the same code twice.	CODE	MASTER
				MANAGER
				USER
				COURIER

Status message on LCD	Cause	Solution	Menu	Submenu
REFUSED 02	Unknown command: The desired function is not available. The installed components are not compatible.	Call the vendor for technical support.	n/a	n/a
REFUSED 04	Lock was closed during configuration.	Make sure that the lock remains open during configuration.	PROG	Any submenu
REFUSED 08	Invalid date (for example Sept. 31 st) Date out of time limit (Jan. 31 st 2000 until Dec. 31 st 2099)	Enter a valid date within the time limit.	TIME	DATE
	Time window out of permitted range (a maximum of 6 days, 23 hours and 59 minutes)	Enter a shorter time window.	PROG	WEEK
	Time window out of permitted range (a maximum of 35 days) Invalid date (for example Sept. 31 st) Date out of time limit (Jan. 1 st 2000 until Dec. 31 st 2099)	Enter a shorter time window	PROG	HOLIDAY
REFUSED 16	The minimum interval (an interrupt) of all delays plus 1 minute was ignored before the next Weekly Locking Period had started.	Enter a valid date within the time limit.	PROG	WEEK
	The minimum interval (an interrupt) of all delays plus 1 minute was ignored before the next Weekly Locking Period had started.	Increase the interval duration.	PROG	HOLIDAY
	The minimum period of time was ignored.	Enter a valid time period. The minimum period of time is calculated by adding the Confirmation Window and 1 additional minute to the higher value of 2 time delays (Time Delay or Duress Time Delay)	PROG	DELAY
REFUSED 32	The memory is full (the maximum of 35 Weekly Locking Periods were defined and entered).	Make sure not to enter more than 35 Weekly Locking Periods.	PROG	WEEK
	The memory is full (the maximum of 22 Holiday Locking Periods were defined and entered)	Make sure not to enter more than 22 Holiday Locking Periods.	PROG	HOLIDAY
REFUSED 64	Unexpected data error.	1. Try again. 2. Call the vendor for technical support.	n/a	n/a
REFUSED 128	Lock is no longer in Programming Mode. After having navigated for more than 5 minutes in the menu without configuring the lock, the Programming Mode will be closed.	Leave the Programming Mode before 5 minutes have passed and enter the Programming Mode again.	any	any

Status message on LCD	Cause	Solution	Menu	Submenu
MOT FLT	A motion fault occurred during bolt movement.	<ol style="list-style-type: none"> 1. Reboot the input unit by removing the batteries. 2. Wait for 1 hour before inserting new batteries. 3. Make sure that the bolt moves smoothly. 4. Make sure that the bolt is not mechanically blocked. 5. Call the vendor for technical support, if the status message does not disappear. 	n/a	n/a
HDW FLT	A hardware fault	Proceed as in steps 1 to 5 for MOT FLT.	n/a	n/a

17.2 Identification of the lowest serial number

The serial number of the locks is a hexadecimal number.

The decimal number system uses 10 digits: 0, 1, 2, 3, 4, 5, 6, 7, 8, 9

The hexadecimal number system uses 16 digits: 0, 1, 2, 3, 4, 5, 6, 7, 8, 9, A, B, C, F

The conversion of the hexadecimal digits A ... F to the decimal numeral system corresponds to: A equals to 10 and F equals to 15.

For the identification of the lowest serial number of a lock, the serial number must be read from left to right and must be compared with the serial number of other locks.

Examples of dual lock systems

	Serial number	Result
Lock 1	43177 30B05 00A	Serial number 1 is lower than serial number 2
Lock 2	43375 32FB3 023	

	Serial number	Result
Lock 1	42984 2EA70 003	
Lock 2	42984 2EA6F 003	Serial number 2 is lower than serial number 1

	Serial number	Result
Lock 1	43375 30B05 00A	Serial number 1 is lower than serial number 2
Lock 2	43375 30B05 0A0	

18 Service

18.1 Cleaning

NOTICE

Damage to surface and interior of the input unit

Cleaning the input unit with aggressive cleaning agents, solvents, abrasive agents or sprays, will cause damage to the surface and interior of the input unit.

- Do not use cleaning agents containing hydrogen peroxide.
- Do not use solvents or abrasive agents.
- Do not use aerosol sprays.
- Do not spray liquids directly onto the surface.
- Avoid getting moisture in the interior of the input unit.



To clean the input unit, use a damp, soft and lint-free cloth and apply a mild cleaning agent.

18.2 Replacing batteries

The input unit is powered by 3 alkaline AA batteries 1.5 V - LR6 or 3 lithium AA batteries 1.5 V - FR6.



Keep in mind that batteries must be changed as soon as the symbol "battery low" appears on the display.

Batteries must be changed latest when the status message "CHANGE BATT" is displayed.

Re-adjust the time and date after replacing the batteries.



After a power interruption (no batteries were inserted or the batteries are empty and the line voltage is off), the function Freeze was set to OFF, the safe lock system will initialize itself newly.

The safe lock system behaves as if it were set up according to the procedure cold plugging. The lock with the lowest serial number becomes the master lock.

To prevent the safe lock system from changing its lock positions, the function Freeze must be set to ON after connecting the first lock. The current master lock will be saved in the system. The function Freeze must be set to OFF.

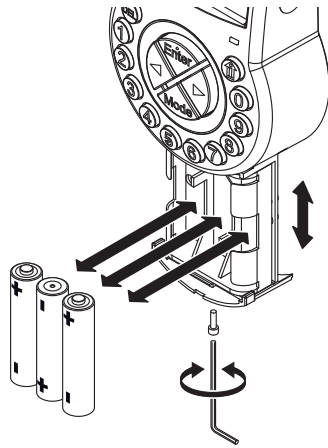

1. Deinstall the screw from the battery compartment on the bottom of the input unit.
2. Carefully pull out the battery compartment until it comes to a stop.
3. Replace the 3 old batteries by 3 new ones of the same type (3 alkaline AA batteries 1.5 V - LR6 or 3 lithium AA batteries 1.5 V - FR6).



If the lock is without power, the internal clock will stop and reset the time to the last hour. All other settings are saved in the power-failure proof memory of the input unit.

4. As soon as the batteries are put in the battery compartment, a test routine will be initiated.
 - ⇒ The following displays appear one after another and a beep signal sounds. The version number can vary.

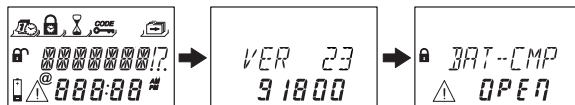

5. Close the battery compartment and install the screw.
6. Wait until the error message **BAT-CMP OPEN** appears again on the display.

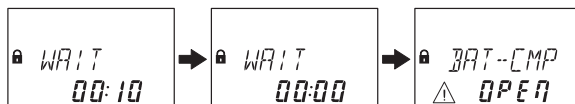

7. Confirm the message by entering the Master Code, any Manager Code or a User Code with the capability to reset the battery message.
 - ⇒ The lock opens and closes again after the set opening time.
 - ⇒ The lock is in normal operating mode.
8. If there is no reaction after having entered the Master Code, any Manager Code or a special User Code (Battery Code), close the lock with opened door.
9. If the lock still does not react, enter the Master Code, any Manager Code or a User Code with the capability to reset the battery message.
10. Repeat the 3 previous steps for each lock of the safe lock system.

19 Maintenance

19.1 Replacing a defect lock

19.1.1 Removing the defect lock from the safe lock system

It is assumed that e.g. lock -9- is defect. The lock must be removed from the bus. The functions Freeze and Lock info are set to OFF on lock -1- (the master lock).

Authorization: Master Code

Checking the defect lock

1. Press the **Right** arrow key to navigate to lock -9-.

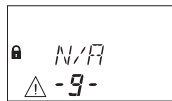

- ⇒ The display shows that the selected lock -9- is not applicable. It is possible that the error message LINE OFF will be displayed. After a few seconds the error message will disappear.

Removing the defect lock from the device list

1. Open lock -1- and prevent the lock from closing.
2. Enter the programming mode.
3. Select the menu **MISC**.
4. Press the **ENTER** key.
5. Select the submenu **DEVICE**



6. Press the **ENTER** key.

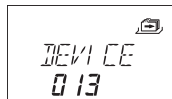

- ⇒ The Device Manager displays the number of all connected devices of the safe lock system.

7. Press the **Right** arrow key to select the defect device.

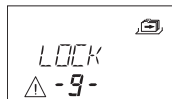

- ⇒ The defect device will be displayed.

8. Press the **ENTER** key.

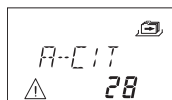

- ⇒ The type of safe lock with the version number will be displayed.

9. Press the **Right** arrow key.

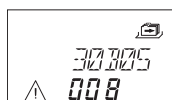

⇒ The last 8 digits of the serial number of the defect lock will be displayed.

10. Press the **Right** arrow key.

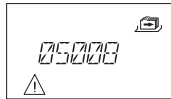

⇒ The customized 5-digit number will be displayed. By default, these are the last 5 digits of the serial number.

11. Press the **Right** arrow key.

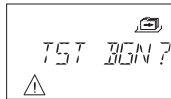

⇒ A bus system test of the selected device can be started.

12. Press the **Right** arrow key.



⇒ The defect lock -9- can be removed.

13. Press the **ENTER** key.

14. Select "YES" in the "SURE?" dialog by using the **LEFT** or **RIGHT** arrow key.

15. Press the **ENTER** key to confirm the setting.

⇒ The display shows ACCEPTED.
The defect lock is removed from the device list.

Removing the defect lock from secure storage unit

1. Remove the defect lock.

19.2 Adding a new lock to the safe lock system

19.2.1 Adding a new lock with Freeze OFF



If more than 1 lock must be replaced, it is necessary to apply the function MOVE TO in order to add a new lock to the desired lock position.

It is assumed that e.g. lock -9- was defect and the lock was removed from the safe lock system. The safe lock systems indicates that lock position -9- is vacant.

The functions Freeze and Lock info are set to OFF on lock -1-(the master lock). A new lock will be added to lock position -9-.

Authorization: Master Code

1. Add the new lock to the secure storage unit.
2. Connect the bus cable from terminal X2 of the previous lock to terminal X1 of the newly added lock.
3. Connect the bus cable from terminal X2 of the newly added lock to terminal X1 of the subsequent lock.

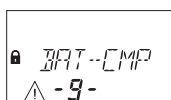

- ⇒ After a few seconds the new lock will be placed automatically to the vacant lock position -9-.
The display shows a warning that the battery compartment of the newly added lock was opened.

4. Enter a Battery Code to be able to operate the lock.

19.2.2 Adding a new lock with Freeze ON

The function Freeze is set to ON and the Lock info is set to OFF on lock -1- (master lock).

It is assumed that e.g. lock -9- was defect and the lock was removed from the safe lock system. The safe lock systems indicates that lock position -9- is vacant. A new lock will be added to lock position -9-.

Authorization: Master Code

Adding a new lock

1. Add the new lock to the secure storage unit.
2. Connect the bus cable from terminal X2 of the previous lock to terminal X1 of the newly added lock.
3. Connect the bus cable from terminal X2 of the newly added lock to terminal X1 of the subsequent lock.



- ⇒ After a few seconds the new lock will be assigned to position -16-.
The display shows a warning with an error message for the newly assigned lock.

4. Press the **LEFT** or **RIGHT** arrow key as long as the error message with the lock position -16- will be displayed.



Changing the function Freeze to OFF

1. Open lock -1- and prevent the lock from closing.
2. Enter the programming mode.
3. Select the menu **MISC**.
4. Press the **ENTER** key.
5. Select the submenu **FREEZE**



6. Press the **ENTER** key.
7. Select **OFF** by using the **LEFT** or **RIGHT** arrow key.



8. Press the **ENTER** key to confirm the setting.
9. Select "YES" in the "SAVE?" dialog by using the **LEFT** or **RIGHT** arrow key.
10. Press the **ENTER** key to confirm the setting.

11. Press the **DEL** key several times to exit the programming mode.

Assigning the new lock to the vacant position

1. Wait until the new lock will be placed automatically to the vacant lock position -9-.
2. Press the **LEFT** or **RIGHT** arrow key several times.

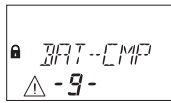

⇒ The new lock has been assigned to the vacant lock position, when the display shows a warning with battery compartment open.

Changing the function Freeze to ON

1. Open lock -1- and prevent the lock from closing.
2. Enter the programming mode.
3. Select the menu **MISC**.
4. Press the **ENTER** key.
5. Select the submenu **FREEZE**

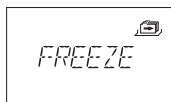

6. Press the **ENTER** key.
7. Select **ON** by using the **LEFT** or **RIGHT** arrow key.



8. Press the **ENTER** key to confirm the setting.
9. Select "YES" in the "SAVE?" dialog by using the **LEFT** or **RIGHT** arrow key.
10. Press the **ENTER** key to confirm the setting.
11. Press the **DEL** key several times to exit the programming mode.

Enabling the new lock for operation

1. Enter a Battery Code to be able to operate the lock.

19.3 Removing the error message of lock position -16-

1. Open lock -1- and prevent the lock from closing.
2. Enter the programming mode.
3. Select the menu **MISC**.
4. Press the **ENTER** key.
5. Select the submenu **DEVICE**.

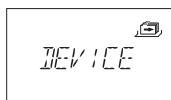

6. Press the **ENTER** key.



⇒ The Device Manager displays the number of all connected devices of the safe lock system.

7. Press the **Right** arrow key to select Lock -16-.



⇒ Lock -16- will be displayed.

8. Press the **ENTER** key.

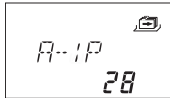

⇒ The type of safe lock with the version number will be displayed.

9. Press the **Right** arrow key.



⇒ Dashes will be displayed instead of the last 8 digits of the serial number. The lock was not accepted in the lock list.

10. Press the **Right** arrow key.

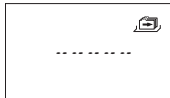

⇒ Dashes will be displayed instead of the customized 5-digit number. The lock was not in the lock list.

11. Press the **Right** arrow key.

⇒ The message with the bus system test will be displayed.

12. Press the **Right** arrow key.

⇒ Lock -16- can be removed.

13. Select "YES" in the "SURE?" dialog by using the **LEFT** or **RIGHT** arrow key.

14. Press the **ENTER** key to confirm the setting.

⇒ The display shows ACCEPTED.
Lock -16- is removed from the device list.

20 Disposal



Do not dispose used batteries in domestic waste.
Dispose batteries according to the local or national regulations.

Packaging material must be disposed or recycled according to national or local regulations.

At the end of the service life, the unit and its components must be returned to the manufacturer or must be disposed at a collecting point.

21 Spare parts and accessories

Spare part	Part name
Axessor IP input unit	AXESSOR-IPIU
Axessor IP lock unit	AXESSOR-IPLOCK
Axessor IP latchbolt lock unit without VdS certification	AXESSOR-IPLLOCK
Replacement WiBu dongle for AS284-W Administrator dongle	AS284-AW
Replacement dongle for AS284 installation dongle	AS284-INSW
AS284-W programming software with virtual dongle	AS284-INSWV
Replacement WiBu dongle for AS284 Operator dongle	AS284-OW
Axessor installation kit	52 INST-S
USB data cable	1364-8
Connecting cable for lock/input unit/eBox 55 cm	52X+CAB55

Accessory	Part number
Power supply for Axessor / Paxos eBox 100-240 VAC / 6 VDC	POWER-VDC12
Axessor power supply 100-240 VAC / 6 VDC	52XVDC6
AS280-W installation software	AS280-INSW
AS280-W installation software with virtual dongle	AS280-INSWV
AS284-NETW programming software	AS284-NETW
AS284-USB programming software	AS284-USBW