



Package content

- Axessor series safe lock
- Connecting cable between safe lock and input unit
- Axessor series input unit
- Batteries (3x AA (LR6), 1.5V)
- Mounting material

Further documentation

Fact sheet, brochure, Axessor manuals, declaration of conformity, EN1300, UL, ECB-S and VdS certifications is accessible on the web

QR for

English

Deutsch

Italiano

Español



For further languages please check the local dormakaba Axessor product page.



Safe locks
Axessor series

Quick reference guide

2020-09

EN



Table of content

Package content	1
Operating and display elements of the input unit	2
External connections to / from the Axessor series safe lock	3
Code structure and basic operation of Axessor series units	4
Factory settings	11
Quick commissioning and customer-specific configuration of safe locks	14

Operating and display elements of the input unit

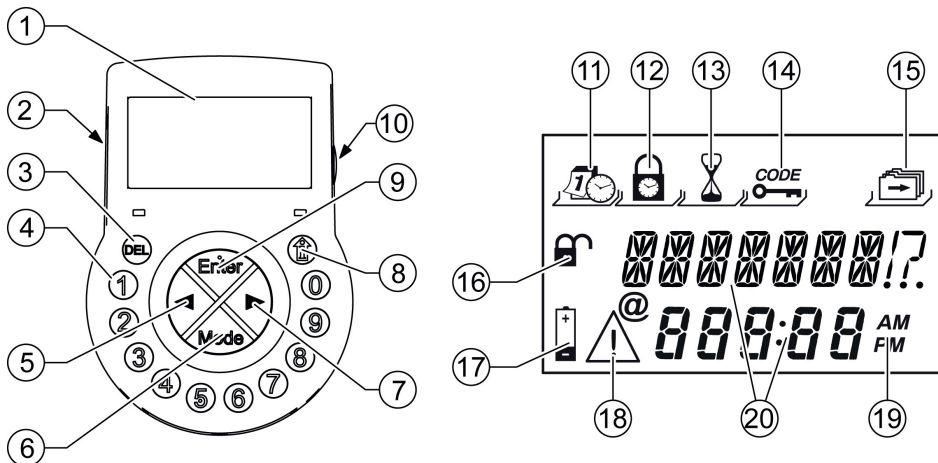

- | | |
|--|-------------------------------------|
| 1 LCD | 11 Menu TIME |
| 2 Buzzer | 12 Menu PROG |
| 3 DEL key (delete / close the lock) | 13 Menu DELAY |
| 4 NUMERIC keys (enter codes) | 14 Menu CODE |
| 5 LEFT key (navigate) | 15 Menu MISC |
| 6 MODE key (programming access) | 16 Lock open / close symbols |
| 7 RIGHT key (navigate) | 17 Replace battery symbol |
| 8 INFO / ESC key (info / one menu up) | 18 Warning symbol |
| 9 ENTER key (confirm entry) | 19 Time format 12h / 24h |
| 10 USB port type B | 20 Text lines |

External connections to / from the Axessor series safe lock

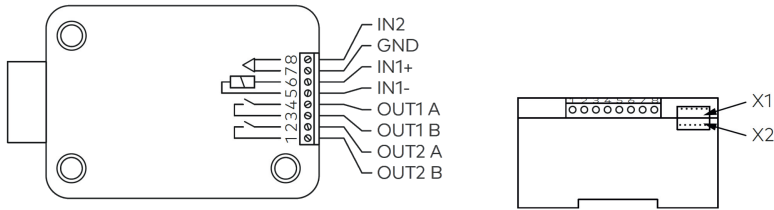

Terminals/ Sockets	Description	Unit	Remarks
1 / 2	Output 2 Factory setting: lock open (OR boolean operation with bolt open or motor open or door open)	Resistive Load: 30VDC / 2A 50VAC / 0.5A	Relay with potential-free working contact, Normally Open (NO). Contact is open, when lock is closed.
3 / 4	Output 1 Factory setting: duress alarm	Resistive Load: 30VDC / 2A 50VAC / 0.5A	Relay with potential-free working contact, NO. Contact is closed, when duress alarm is active.
5(-) / 6(+)	Input 1 Factory setting: off (not assigned)	12VDC / min. 13mA, max. 20mA	---
7 / 8	Input 2 Factory setting: off (not assigned)	Potential-free contact only (do not apply any voltage !)	Use a micro switch with gold-plated contact 12VDC/50mA (e.g. DB series by Cherry). If Input 2 is assigned as "door contact" and not inverted, an open switch contact stands for " door open ". The bolt is open as long as pins 7 and 8 remain electrically disconnected.
X1 / X2	Connection for input unit, eBox or power supply	---	Use the connecting cable in the package. Only use the original Axessor power supply.

Note All Axessor series safe lock inputs and outputs are configurable with the AS284-USBW or AS284-NETW Axessor Programming Software.

Code structure and basic operation of Axessor series units

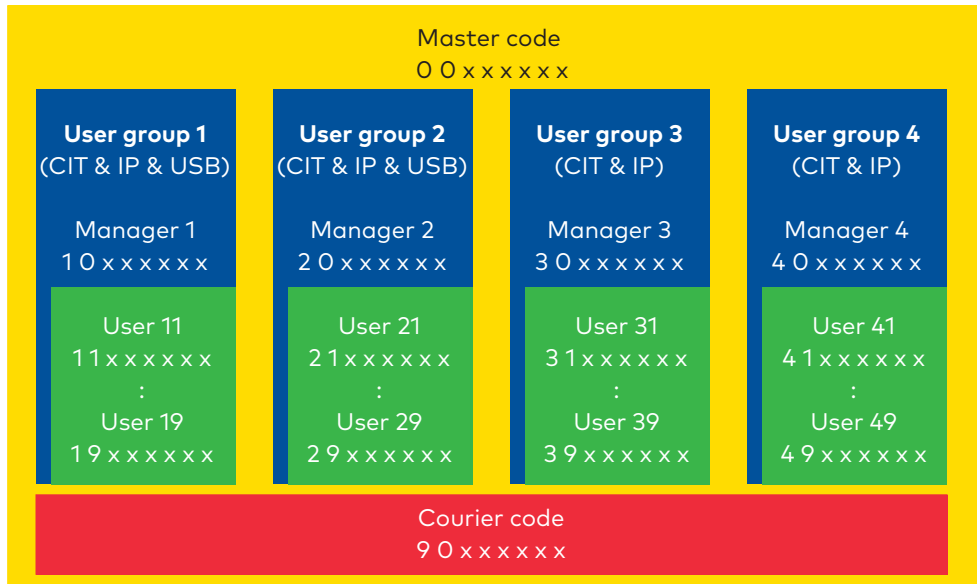

Note The overview shows the code structure of the Axessor series units. Axessor USB safe locks are able to manage a maximum of 2 user groups. Axessor CIT and Axessor IP safe locks are able to manage a maximum of 4 user groups.

Note In a multi lock system, each lock got its own codes!

dormakaba Quick reference guide

Open Lock of a single lock system

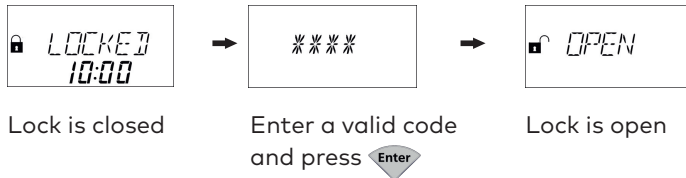

Open Lock of a multi lock system

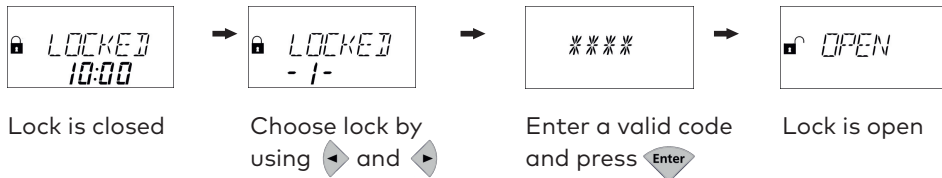

Note When Input 2 of the Axessor series safe lock is not configured as "door contact", the bolt will automatically close after the "Bolt open time in Bank mode" or the "Bolt open time in One time mode (OTM)" has elapsed.

Duress code

Enter the Duress code by adding or deducting the value 1 to or from the last digit of the User, Manager or Master code.

Note Precondition to recognize a Duress code: Duress function must be activated. Axessor IP and CIT units accept any value of +/- 1...9 as Duress code.

Status messages / Part 1

Depending on the selected operating mode and the currently executed operation, the Axessor input unit offers a variety of status messages. The following examples give an overview of important status messages. Please note: list is not complete.

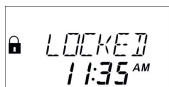

Locked

The lock is mechanically closed. The current time is displayed. It is possible to open the lock by entering a valid code.



Open

The lock or the door switch is mechanically open. It is possible to open the boltwork or safe door during the defined "Bolt open time" in Bank mode or OTM. If the boltwork was not opened, the lock closes automatically after the "Bolt open time" has elapsed.



The battery compartment was opened

This message always appears when the battery compartment is open or was opened. This message also serves as a dismounting information for the input unit because the battery compartment must also be opened to dismount the unit.

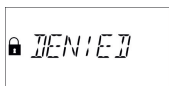

Identification of denied codes / Non-return time delay engaged

This status message appears when identifying with a denied code. It is possible to deny codes with a higher code (Master, Manager or with the AS284-W). The message is also shown as long as an active Non-return time delay refuses to open the lock.

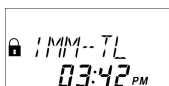

Immediate time lock

The lock is blocked by the immediate time lock and it is not possible to open the lock. The current time is displayed. Set the immediate time lock when the function is activated and the lock is closed: press  and enter a valid code to access directly to menu "PROG / IMM-TL".

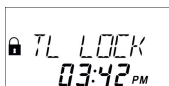

Weekly time lock

The lock is in a weekly locking period and it is not possible to open the lock. The current time is displayed.

Status messages / Part 2



Penalty after wrong trials

A five-minute time penalty is initiated after entering 4 incorrect codes one after another. The remaining penalty time is displayed.

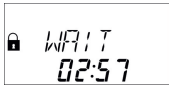

Time delay

If activated, time delay starts counting after a valid code is entered to open the lock. The remaining time is displayed.



Confirmation after elapse of time delay

Once the time delay has elapsed, a code must be entered to open the lock within a set time period. The remaining time is displayed to enter the code.



Dual mode

If the Dual mode is activated, two codes must be entered to open the lock. This message appears when the second code must be entered.

Note: Master code and Courier code can override the Dual mode.

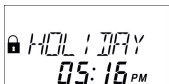

Holiday time lock

The lock is in a holiday locking period and it is not possible to open the lock. The current time is displayed.

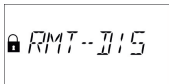

Remote disabling

This message appears when the Remote disabling function is activated. The remote disabling signal is activated and the lock is closed. In this case, the opening of the lock is not possible.

Enter Programming mode

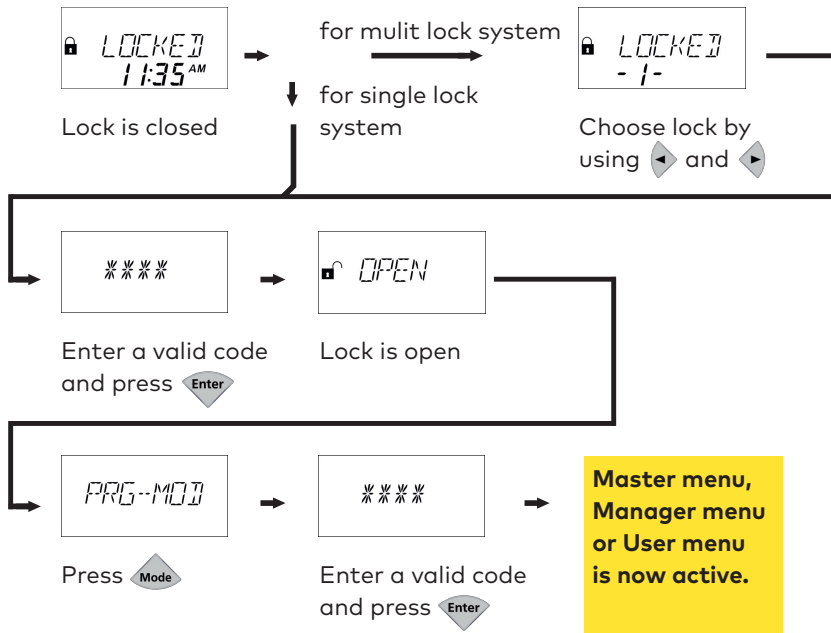

Note There are three different Programming modes available in the Axxessor series. Enter the Master code, Manager code or User code to access the desired programming level.

Note In a multi lock system, the numbering of the locks has to be done in lock 1! To change the numbering, choose lock 1 and enter its programming menu. In menu MISC, use DEVICE to change numbering of the locks. Be aware, that lock 1 cannot be moved. All other locks can be moved, even to number 1. So to exchange the lock 1 with another lock x, move lock x to position 1.

Adjustment of settings and navigation in Programming mode

or Leave the menu without accepting the previously configured setting.



Enter the displayed menu or accept the previously configured setting.

and Select a menu or configure the currently displayed setting.





dormakaba Quick reference guide

Enter the Manager menu

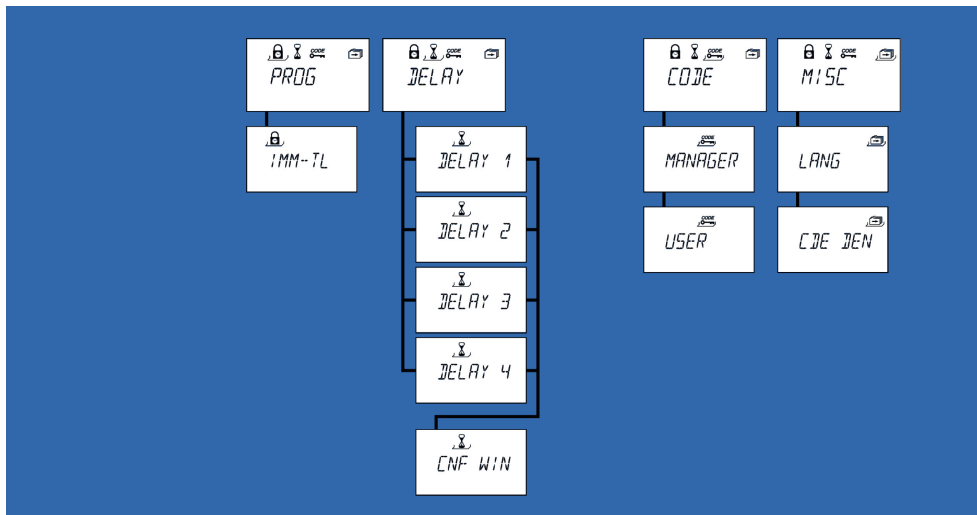
1. Open the lock
2. Press 
3. Enter a **Manager code**
4. Press 



Enter the User menu

1. Open the lock
2. Press 
3. Enter a **User code**
4. Press 



Factory settings / Part 1

Function	Factory setting	Change with				
		USB	IP	CIT	Input unit	AS284-USBW AS284-NETW (optional)
Language in display and in Info menu	English	✓	✓	✓	✓	✓
All languages (English, French, German, Dutch, Italian, Spanish, Hungarian, Polish, Portuguese, Turkish) available in Info Menu	On	✓	✓	✓	✓	✓
Master code	0 0 1 2 3 4 5 6	✓	✓	✓	✓	✓
Master code opens lock	On	✓	✓	✓		✓
Master code overrides immediate time lock (IMM-TL) in closed state	On	✓	✓	✓		✓
Master code bypasses time lock	Off	N/A	✓	✓		✓ (IP) ✓ (CIT)
Manager codes	Off	✓	✓	✓	✓	✓
Settings when Manager codes are on: · open lock · change time delays (TD) · change confirmation window (CONF) · activate immediate time lock (IMM-TL)	· On (USB: fix) · On (USB: fix) · On (USB: fix) · On	✓	✓	✓		✓
User codes (except special User codes)	Off	✓	✓	✓	✓	✓
User code can activate immediate time lock (IMM-TL)	Off	N/A	✓	✓		✓
User code 41 for Audit & battery code	· USB: fix On · IP: Off · CIT: Off	✓	✓	✓		✓ (IP) ✓ (CIT)
User code 42 for activation code (inclusive Audit & battery code)	Off	N/A	✓	✓		✓ (IP) ✓ (CIT)
User codes 45 / 46 for activation of relay output pulse	Off	N/A	✓	✓		✓ (IP) ✓ (CIT)
User code 47 for time code (inclusive Audit & battery code)	· USB: fix On · IP: Off · CIT: Off	✓	✓	✓		✓ (IP) ✓ (CIT)
User codes 48 / 49 for lock disabling / enabling	Off	N/A	✓	✓		✓ (IP) ✓ (CIT)
Courier code	Off	✓	✓	✓	✓	✓
Settings when Courier code is on: · bypass time delay and opens alone even in Dual mode · skips time delay but cannot open lock	· On · Off	✓	✓	✓		✓ (IP) ✓ (CIT)
One shot code for group 4	Off	N/A	✓	✓	✓ (IP) ✓ (CIT)	✓ (IP) ✓ (CIT)

Factory settings / Part 2

Function	Factory setting	Change with				
		USB	IP	CIT	Input unit	AS284-USBW AS284-NETW (optional)
Buzzer volume	High	✓	✓	✓	✓	✓
Beep each 30 seconds while lock is open	On	✓	✓	✓	✓	✓
Beep each 60 seconds while (duress) time delay counts	On	✓	✓	✓	✓	✓
Beep each 60 seconds while confirmation window counts	On	✓	✓	✓	✓	✓
Door open beep alarm	Off	N/A	✓	✓	✓ (IP) ✓ (CIT)	✓
Number of wrong codes before penalty	4	✓	✓	✓		
Penalty upon wrong code entries	5 minutes	✓	✓	✓		
Code denial: · temp. lockout of Manager codes and User groups · temporary lockout of single users	Off	✓	✓	✓	✓	✓ ✓
Duress code entry	Off	✓	✓	✓	✓	✓
Duress code criterion (last digit)	+/- 1 (USB:fix)	✓	✓	✓		✓ (IP) ✓ (CIT)
Time related functions for up to 3 user groups, partial, weekdays: · time related time delay · time related toggle Dual mode · time related code disabling	Off	N/A	✓	✓	✓ (IP) ✓ (CIT)	✓ (IP) ✓ (CIT)
Dual mode	Off	✓	✓	✓	✓	✓
Settings when Dual mode is on: · any two codes · two codes of same group · two codes of different groups · two Manager codes for Programming mode · Manager code cross accesses User codes	· On (USB: fix) · Off · Off · Off · Off	✓ N/A N/A N/A N/A	✓ ✓ ✓ ✓ ✓	✓ ✓ ✓ ✓ ✓		✓ (IP) ✓ (CIT)
ICS operation (Single mode or Dual mode)	Off	N/A	N/A	✓		✓ (CIT with AS280-W)
OTC operation	Off	N/A	N/A	✓		✓ (CIT with AS280-W)
Mixed mode	Off	N/A	N/A	✓		✓ (CIT with AS280-W)
Time delay in Bank mode	0 minutes	✓	✓	✓	✓	✓
Duress time delay in Bank mode (per group)	1 minute	✓	✓	✓		✓

Factory settings / Part 3

Function	Factory setting	Change with				
		USB	IP	CIT	Input unit	AS284-USBW AS284-NETW (optional)
Time delay in One Time Mode (OTM)	0 minutes	N/A	N/A	✓	✓ (CIT)	✓ (CIT)
Duress time delay in One Time Mode (OTM)	99 minutes	N/A	N/A	✓	✓ (CIT)	✓ (CIT)
Time delay and duress time delay	Count down	✓	✓	✓		✓ (IP) ✓ (CIT)
Non-return time delay in One Time Mode (with CIT) and Bank mode (with IP & CIT)	0 minutes	N/A	✓	✓	✓ (IP) ✓ (CIT)	✓ (IP) ✓ (CIT)
OTM overrides non-related time delay	Off	N/A	N/A	✓	✓ (CIT)	✓ (CIT)
Bolt open time in Bank mode	6 seconds	✓	✓	✓	✓ (IP) ✓ (CIT)	✓
Bolt open time in One Time Mode (OTM)	2 minutes	N/A	N/A	✓	✓ (CIT)	✓ (CIT)
Process time	2 min. 30 sec.	N/A	N/A	✓	✓ (CIT)	✓ (CIT)
Wake up mode	CIT	N/A	N/A	✓	✓ (CIT)	✓ (CIT)
Confirmation window (CONF)	5 minutes	✓	✓	✓	✓	✓
Immediate time lock period	0 minutes	✓	✓	✓	✓	✓
Maximum adjustable value for immediate time lock period	144 hours	✓	✓	✓		✓
Opening windows for time lock interruption	Off	N/A	✓	✓	✓ (IP) ✓ (CIT)	✓ (IP) ✓ (CIT)
Time lock functions also cover OTM	Off	N/A	N/A	✓	✓ (CIT)	✓ (CIT)
Date Time	01.01.2019 0:00	✓	✓	✓	✓	✓
Time format (24hours or 12hours AM/PM)	24 hours	✓	✓	✓	✓	✓
Change of summer / winter time (Daylight Saving Time) and factory setting of time zone	On to Central European Time	✓	✓	✓	✓	✓
Remote disabling by software	Off	✓	✓	✓	✓	✓
Input 1: one function optionally assignable (remote disabling / controlled disabl. / remote enabling / cancel non-return time delay)	Off	✓	✓	✓		✓
Input 2: one function optionally assignable (door contact / skip time delay / time lock interruption / remote disabling / controlled disabling / external input event A – F / remote enabling / cancel non-return time delay)	Off	✓	✓	✓		✓
Output 1: duress alarm	On	✓	✓	✓		✓
Output 2: lock open (OR boolean operation with lock open or motor open or door open)	On	✓	✓	✓		✓



Quick commissioning and customer-specific configuration of safe locks

The local regulations for installation, safety and security must be complied with.

Installing the lock

- 1) Mark 3 fixation holes (A) according to the drilling template for input unit.
- 2) Drill fixation holes with M6 threads.
- 3) Install the lock with the three M6x10 screws (it is also possible to use similar inch screws).
- 4) Make sure that the screw heads rest on the base of the shouldered fixation hole.
- 5) Observe the maximum force of 5N in both directions.
- 6) Make sure that the connector is in the correct position.
- 7) Carefully plug the connecting cable into 1 of the lock sockets X1 or X2.

Installing the input unit

- 1) Remove the 3 screws from the bottom of the cover (1 installed in the battery compartment, 2 installed in the housing).
- 2) Remove the cover from the base plate.
- 3) Carefully remove the battery compartment.
- 4) Install the base plate with the special M4x12 flat-head screws onto the door.
→ The input unit must be installed onto the door with at least 2 oppositely positioned screws.
→ The third screw is recommended.
- 5) Carefully route the connecting cable through the Ø10mm cable feed-through in the door and into the lock chamber.
- 6) Install the battery compartment in place.
- 7) Carefully route the battery cable through the strain relief guides of the battery compartment and the base plate.
- 8) Plug the battery cable into the 2-pole connector terminal and the connecting cable into the 6-pole connector terminal.
- 9) Make sure that the position of the plugs is correct before connecting the plugs.
- 10) Engage the cover in the notch on top of base plate.
- 11) Slowly hinge down the cover onto the base plate while carefully routing the connecting cable to the lock chamber.
- 12) Make sure that the cables will not be squeezed.
- 13) Make sure that the battery compartment is free moving.
- 14) Install the cover onto the base plate using 2 M3x6 countersunk screws.
- 15) Insert the batteries and push the battery compartment into the input unit.
Make sure that the **battery compartment operates the micro-switch** on the PCB.
- 16) The input unit starts. If the beep signal does not stop, repeat step #15 above.



Configuration through input unit

- 1) Open the safe lock (e.g. by entering the factory set Master code **0 0 1 2 3 4 5 6**).
- 2) Make sure that the bolt remains retracted during configuration of the safe lock. (Please consider the factory setting of 6 seconds for the "Bolt open time". The lock closes automatically after the "Bolt open time" has elapsed.)
- 3) Use the Master, Manager or User code to enter the desired programming level.
- 4) Configure the safe lock according to the customer specifications and write down the settings. (Note: The lock must be open during configuration.)
- 5) Leave from the programming mode by pressing the **DEL** or the **↑ INFO** key.
- 6) Release the bolt to leave the customer-specific configuration.

Configuration with AS284-USBW / AS284-NETW Axessor Programming Software

- 1) Connect the admin or operator dongle to the PC and start the AS284-W software. (Note: Please contact the local dormakaba support to order the software.)
- 2) Connect the input unit to the PC via an USB cable with plugs of type A-B.
- 3) In AS284 **Locks overview** check the serial number and select the desired safe lock.
- 4) In menu **<Additional/Inputs>** set the checkbox to **Door contact** on **Inp.2** (Input 2).
- 5) Enter a valid code in input unit to open the safe lock: the **bolt opens**.
- 6) Click the software button **<Apply>** of AS284-W within 6 seconds (factory setting) before the "Bolt open time" elapses: the **bolt remains retracted**. (Note: Repeat steps 5 and 6 when the bolt closes automatically or the software AS284-W reports that the lock refused the last reading or writing operation.)
- 7) Configure the safe lock according to the customer specifications.
- 8) Check the configuration: select the menu **<Main / Audit>** and press **<Read audit>**.
- 9) Disconnect the input unit from the PC, leave the customer-specific configuration.

Note For further information on configuration, refer to the Axessor Technical Manual. QR code to access the internet download site is on page 1.

Setup of a lock system with multiple locks

- 1) Install the input unit and lock 1.
- 2) Power up the system.
- 3) Freeze and unfreeze the system (see Programming menu - MISC - FREEZE).
- 4) Connect next lock.
- 5) Check, if lock is recognized on the correct position. If not, move it to the correct position (use the programming menu of lock 1 - MISC - DEVICE).
- 6) Repeat step 4) and 5) until all locks are installed.
- 7) **Finally freeze the system** (Programming menu - MISC - FREEZE - FREEZE ON).



This documentation may not be reproduced or distributed in any way – neither in digital nor in photographic form without prior written permission of dormakaba Schweiz AG.
© by dormakaba Schweiz AG, CH-8620 Wetzikon.

dormakaba Schweiz AG
Mühlebühlstrasse 23
8620 Wetzikon
T: +41 44 931 61 11
www.dormakaba.com



www.dormakaba.com

Quick Reference Guide 1760000367
Axessor series September 2020
Subject to change without notice !

