

ES 200 T Easy

ES 200 T

ES 200 T-2D

Telescopic

Sliding door operator

Large passage capacity with a small but powerful operator

Outstanding solutions for tight spaces.

ES 200 T automatic telescopic sliding door operators create a large clear passage width despite a relatively narrow aperture, but the reasons for their extensive applicability do not stop there.

In the 2D version, they come with a redundant drive system, auxiliary safety control and special radar motion detector. They are thus supplied TÜV type-approved as "automatic sliding doors without break-out, approved for use in emergency exits and escape routes" for opening widths up to 4000 mm.

The modular system

The modular design of the ES 200 T provides an ideal basis for the implementation of new ideas and individual concepts in the design and construction of sliding door systems.

The identical mechanical components can be used in all three versions of the operator (ES 200 Easy, ES 200 T and ES 200 T-2D).

dormakaba has also opened up a new dimension with its control system. Now there is no longer any need to replace components when you want to expand the functionality of your system. In future, "docking" will be the order of the day. The modular control system comprises of the basic control module (BM) and the function module (FM). Consequently, upgrading in accordance with individual customer requirements can be carried out without problem. Particularly impressive is the prefabricated MiniDriveUnit, industrially tested and equipped with all the necessary electrical and electronic components.

Startup with ASP software

The commissioning or initial setting of all standard parameters is done quickly and easily via an integrated display with push buttons on the front of the control. Particularly comfortable is the optional programming with the dormakaba ASP software.

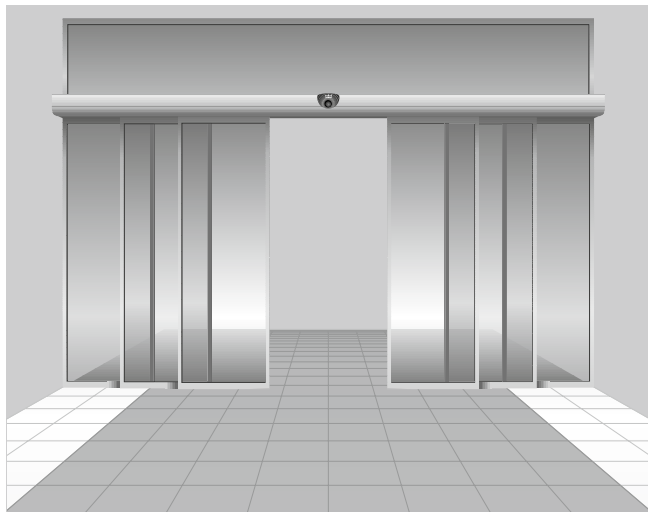

Integrated power

With its extra-powerful motor and a dynamic acceleration/ deceleration (operating curve) control capability, the integrated PowerDrive system ensures safe and reliable operation and it can readily cope with sliding door weights of up to 4 x 75 kg per door panel.

Exceptional cost-efficiency

With the ES 200 T, dormakaba offers a drive system of modular design capable of covering every application on the basis of just a few components. The system offers easy assembly and installation, reduced storage and stocking costs, and simple maintenance for enhanced operational cost efficiency.

A system for the future

With this system you are investing in the future. You also have the security derived from our decades of experience in the automatics business – a history that sets dormakaba apart as the market leader in drive and control systems for doors.

The ES 200 T corresponds to all the latest European and German standards and safety regulations.

The required safety devices according to DIN 18650 (Germany) and EN16005:2012 result from the respective risk assessment.

Features and advantages

- Modular, flexible system.
- With dormakaba PowerDrive: Dynamically controlled acceleration and deceleration curves for particularly powerful operation – and with emergency power backup in the form of a rechargeable battery pack.
- Industrially prefabricated and tested **MiniDriveUnit**.
- Modular control system upgradeable with additional functional modules.
- Integrated DCW (dormakaba Connect and Work) bus system for easy integration of dormakaba DCW sensors and actuators.
- Can be combined with all customary door profiles.
- Fully comprehensive range of accessories.
- Reliable investment due to compliance with all relevant European and German standards.

Door parameters		ES 200 T Easy	ES 200 T	ES 200 T-2D
Application in emergency exits and escape routes				
2-panel sliding door	- Clear passage width LW - Door panel weight max.	800 – 2400 mm 2 x 50 kg	800 – 2400 mm 2 x 75 kg	1000 – 2400 mm 2 x 75 kg
4-panel sliding door	- Clear passage width LW - Door panel weight max.	1400 – 4000 mm 4 x 43 kg	1400 – 4000 mm 4 x 75 kg	1400 – 4000 mm 4 x 65 kg
Clear passage height*		2100 – 3200 mm	2100 – 3200 mm	2100 – 3200 mm

*Other dimensions on request.

Technical data of operator		ES 200 T Easy	ES 200 T	ES 200 T-2D
Height	100 und 150 mm	●	●	●
Overall depth	252 mm	●	●	●
Opening and closing force	max. 150 N	●	●	●
Opening speed (incremental setting)		10 – 70 cm/s	10 – 70 cm/s	10 – 70 cm/s
Closing speed (incremental setting)		10 – 50 cm/s	10 – 50 cm/s	10 – 50 cm/s
Hold-open time		0,5 – 180 sec.	0 – 180 sec.	0 – 180 sec.
Mains voltage, frequency	230 V, 50/60 Hz	●	●	●
Power supply		250 W	250 W	250 W
Class of protection	IP 20	●	●	●
Compliant with EU low-voltage directives		●	●	●
Manufactured to ISO 9001:2000		●	●	●

Basic module (BM)		ES 200 T Easy	ES 200 T	ES 200 T-2D
Modular design		●	●	●
Microprocessor-controlled function programs	- Off	●	●	●
	- Automatic	●	●	●
	- Permanent opening	●	●	●
	- Partial opening	●	●	●
	- Exit only	●	●	●
	- Night-bank control	●	●	●
Connections for electro-mechanical locking on light barriers		●	●	●
Adjustment of all basic parameters via integrated display and pushbuttons		●	●	●
PDA Organizer parameter setting		-	●	●
24 V output for external loads		●	●	●
Read-out error memory with error codes		●	●	●
DCW®-bus interface		-	●	●
Rechargeable battery pack for emergency operation		○	○	●

Function module (FM) – optional extra		ES 200 T Easy	ES 200 T	ES 200 T-2D
Pharmacy control		-	○	○
Door status control (triple-mode)		-	○	○
Main and secondary closing edge protection		-	○	○
Emergency closing function		-	○	-
Bell contact		-	○	○
Airlock control		-	○	-
Synchronising mode		-	○	○

DIN 18650 function module – optional		ES 200 T Easy	ES 200 T	ES 200 T-2D
The DIN 18650 function module enables the tested monitoring of the secondary closing edges in order to comply with the German standard DIN 18650.		-	○	○

Additional equipment		ES 200 T Easy	ES 200 T	ES 200 T-2D
Electro-mechanical locking (bistabil)		○	○	○
Manual release of electro-mechanical locking		○	○	○
Light barriers		○	○	○
Backup battery pack (emergency opening, emergency closing) (ES 200 T-2D standard)		○	○	●
Module for coupling to EIB or LON building control systems		○	○	○

● standard ○ optional - not available

ES 200 T EASY, ES 200 T, ES 200 T-2D

The performance operators for generous passage widths

dormakaba PowerDrive System for particularly punchy performance

Door variants, 100 mm overall height

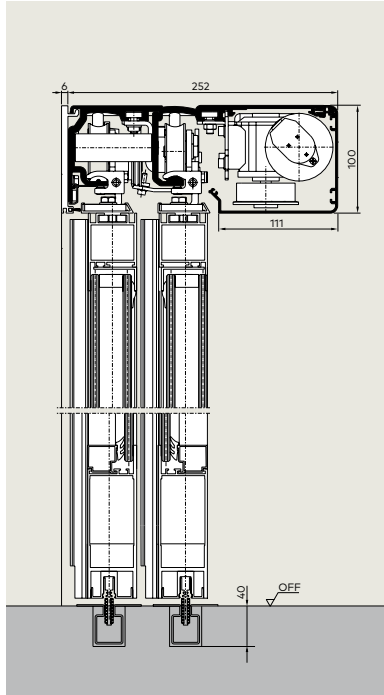

with fine frame profiles with side screen

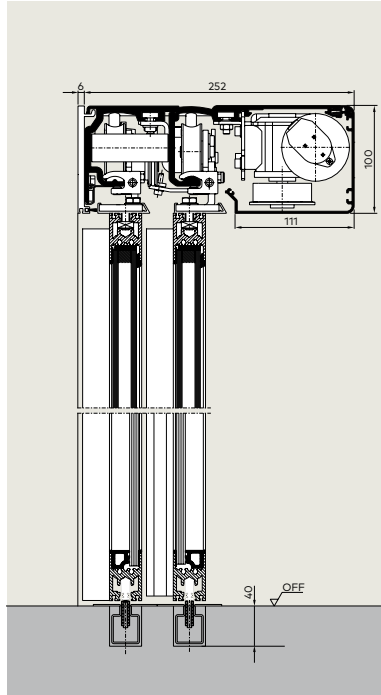

with fine frame profiles without side screen

Door variants, 150 mm overall height

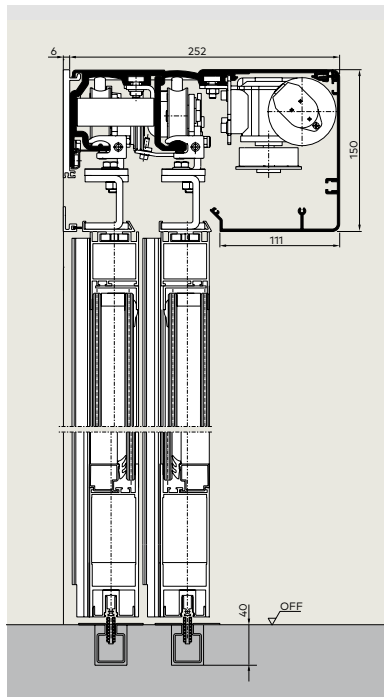

with fine frame profiles with side screen

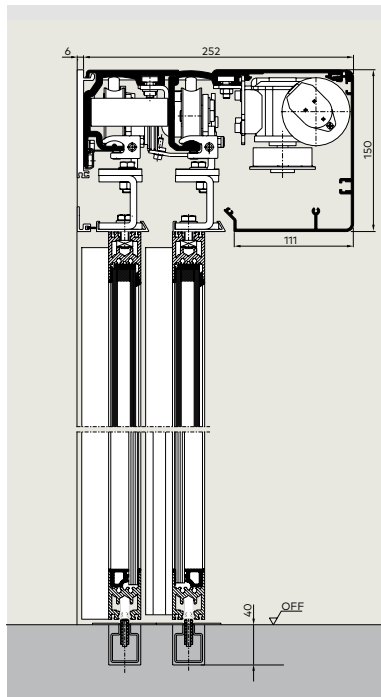

with fine frame profiles without side screen

Door variant for use with skylights and side panels

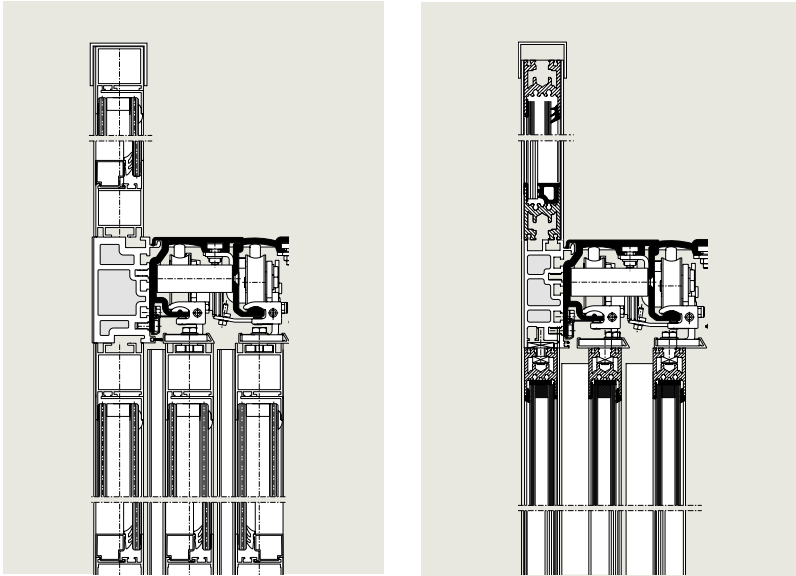

MiniDriveUnit (MDU) Easy

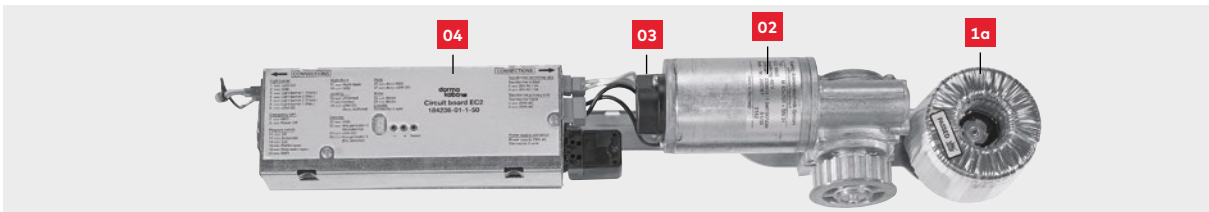

MiniDriveUnit (MDU) Standard

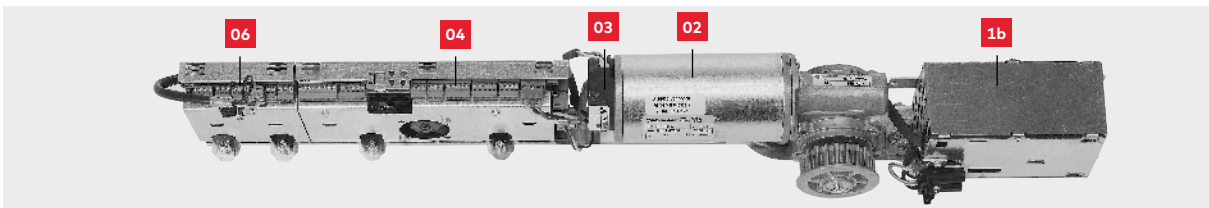

MiniDriveUnit (MDU) with DualDrive

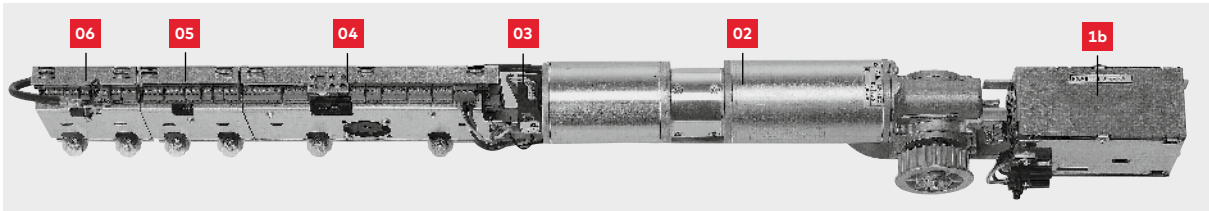

At the heart of the ES 200 T operator is a preassembled MiniDriveUnit (MDU), which comes in various versions: EASY/Standard/2D.

It has been industrially tested with all the necessary electrical components and, as a handy single unit, greatly facilitates the installation and maintenance of operator assemblies.

**Components
MiniDriveUnit with DualDrive**





- 1a** Transformer
- 1b** Power supply unit
- 2** Motor
- 3** Decoder
- 4** Basic control module (BM) Easy or Standard
- 5** **DualDrive**-Modul (2D-unit)
- 6** Function module (FM)



Program switches

When combining the system with a program switch out of the dormakaba accessory range, the automatic door system meets individual requirements and offers easy handling. Program switches are available in various designs and have been conceived for all kinds of demands.

Furthermore they offer various options, from a mechanical to a full-electronic version alternatively also lockable via Euro profile half-cylinder or in a full-electronic way via code.





- Up to 5 different functions:
Off, Automatic, Exit Only, Partial Open, Permanent Open
- Electronic program switches in System 55 design to cope with the highest aesthetic demands

For sliding door operators	Designation	Specification	Installation system	Order No.
	PG-S1	5-position, aluminium, white, UP, 80 x 80 x 40 mm	Gira S-Color	19135401150
	PG-S2	5-position, lockable, aluminium, white, flush-mounting, 80 x 80 x 40 mm	Gira S-Color	19135602150
	PG-FST2	5-position, lockable via Euro profile half-cylinder, also suitable for FST systems, aluminium, white, for flush-mounting, 105 x 80 x 65 mm Box for surface-mounting: 19142201170	Deutsche Solenoid	19135602150
	EPS-S	Full-electronic program switch in System 55 design, 5-position, lockable via code or additional key switch TL-ST S55, membrane keypad, aluminium-coloured, white, flush-mounting, 80 x 80 mm	System 55	16556901150
	For header installation PS-FST3*	5-position, lockable, also suitable for FST systems		25006014150

For sliding door operators in emergency exits and escape routes (FST)	Designation	Specification	Installation system	Order No.
	PG-FST1	5-position, lockable, aluminium, white, flush-mounting, 80 x 80 mm	Gira S-Color	19135603150
	PG-FST2	5-position, lockable via Euro profile half-cylinder, white, aluminium, flush-mounting, 105 x 80 x 65 mm, Box for surface-mounting: 19142201170 (see page 11)	Deutsche Solenoid	19142001170
	EPS-FST	Full-electronic program switch in System 55 design, 5-position, lockable via code or additional key switch TL-ST S55, membrane keypad, white, aluminium-coloured, flush-mounting, 80 x 80 mm	System 55	16556801150
	For header installation PS-FST3*	5-position, lockable		25006014150

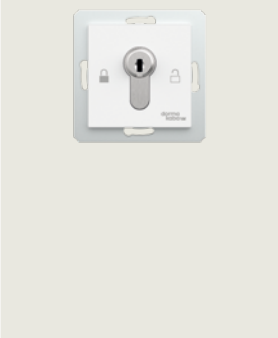

* no illustration

Pushbuttons



Pushbutton	Designation	Specification	Installation system	Order No.
		Single-pole changeover contact, standard frame, white, flush-mounting	System 55	19144701170
	KT 3-1	1 NO contact, with Euro profile half-cylinder (can be replaced by any half-cylinder of a master-key system), you can only withdraw the key when it is in zero position, aluminium, metal, 75 x 75 x 60 mm		
	KT 3-1 UP	flush-mounting		05054531332
	KT 3-1 AP	surface-mounting		05054631332
	KT 8	Lettering "Auf, Zu" (German for "Open/Closed"), 2 NO contacts, with Euro profile half-cylinder (can be replaced by any master-key system half-cylinder), key only retractable in neutral position, aluminium, metal, 75 x 75 x 60 mm		
	KT 8 UP	flush-mounting		05054831332
	KT 8 AP	surface-mounting		05054931332
	Key switch TL-ST key switch out of STA range			
	TL-ST S55	Switch with single-pole changeover contact, for Euro profile half-cylinder by others to DIN 18252, locking cam centre 30 – 32.5 mm, overall length 40.5 – 43,5 mm, Locking cam position left (90°), incl. cover for System 55, not suitable for box for surface-mounting, not including Euro profile half-cylinder, not including frame		
	TL-ST S55 W	white	System 55	56330710
	TL-ST S55 S	silver	System 55	56330701
	TL-ST S55 A	anthracite	System 55	56330715
	KT 3-2	1 NO contact with Euro profile half-cylinder, can be replaced by any master key system half-cylinder, key only retractable in neutral position, interchangeable cover, lettering "Ein, Aus" (German for "On/Off"), aluminium, for flush-mounting: 125 x 100 mm, for surface-mounting: 70 x 90 mm		05054731332
	KT 3-2.1*	2 changeover contacts, with Euro profile half-cylinder, replaceable by any master-key system half-cylinder, key only retractable in neutral position, lettering "Ein, Aus" (German for "On/Off"), aluminium, for flush-mounting: 125 x 100 mm, for surface mounting: 70 x 90 mm		05032631332

* no illustration

Switches

Switches	Designation	Specification	Installation system	Order No.
	On / Off switch	white, aluminium, flush-mounting, 80 x 80 mm	Gira S-Color	19135403150
	Radar switch	"MAGIC SWITCH", proximity-type radar switch responds to movement, for flush-mounting, 80 x 80 mm		05076831332

Emergency pushbutton

Emergency pushbutton	Designation	Specification	Installation system	Order No.
		To interrupt the automatic movement of the door. Emergency pushbutton (Function: Emergency Off) for automatic door operators. Manufactured according to ZH 1/494 (German Guidelines for power-operated windows, doors and gates) and BGR 232 (German Employer's Liability Insurance Association Rule) as well as DIN 18650 (German Industrial Standard). Red knob with yellow centre insert. Maximum load current: max. 10 A at 230 V AC.		
	NAT 1	NO contact: 1, NC contact: 1, white frame, flush-mounting, 80 x 80 mm	System 55	90400025
	NAT 2*	Function: "Emergency Open" with green knob, NO contact: 1, NC contact: 1, Maximum load current: 10 A at 230 V AC, white frame, flush-mounting, 80 x 80 mm Highly-illuminated emergency pushbutton environment with visual locking status indication, optical and acoustic alarm via yellow flashlight and integrated alarm siren, sabotage-proof, behind glass, not including frame	System 55	90400035
	TL-N S55	NO contact: 1, NC contact: 1, Maximum load current: 1 A at 24 V DC, flush-mounting, 80 x 80 mm	System 55	56330500
	NAT 3*	Behind glass, NO contact: 1, NC contact: 1 for flush-mounting, 120 x 87 mm		90400023
	NAT 4	NO contact: 1, NC contact: 1, for surface-mounting, 68 x 68 mm		05027031332

* no illustration

Frames and boxes for surface-mounted pushbuttons and switches

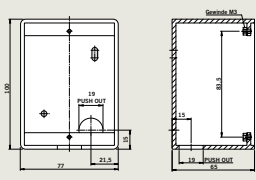



Frames	Designation	Specification	All dimensions in mm W x H x D	Installation-system	Order No.	
	System 55	Cover frame (STA range)				
	FR-S55 1	Single-type frame, Standard 55, white	80.7 x 80.7	System 55	56391110	
	FR-S55 2	Double-type frame, Standard 55, white	151.8 x 80.7	System 55	56391210	
	FR-S55 3	Triple-type frame, Standard 55, white	223.3 x 80.7	System 55	56391310	
	FR-E2W 1	Single-type frame, E2 55, white	80.8 x 80.8	System 55	56392110	
	FR-E2W 2	Double-type frame, E2 55, white	151.9 x 80.8	System 55	56392210	
	FR-E2W3	Triple-type frame, E2 55, white	223.4 x 80.8	System 55	56392310	
	FR-E2S 1	Single-type frame, E2 55, silver	80.8 x 80.8	System 55	56392101	
	FR-E2S 2	Double-type frame, E2 55, silver	151.9 x 80.8	System 55	56392201	
	FR-E2S3	Double-type frame, E2 55, silver	223.4 x 80.8	System 55	56392301	
	FR-E2A 1	Single-type frame, E2 55, anthracite	80.8 x 80.8	System 55	56392115	
	FR-E2A 2	Double-type frame, E2 55, anthracite	151.9 x 80.8	System 55	56392215	
	FR-E2A3	Triple-type frame, E2 55, anthracite	223.4 x 80.8	System 55	56392315	
		Please see STA price list for further frames and versions.				
		System 55	Boxes for surface-mounting for Standard 55 frames			
ST-AP 55-1*		Single-type frame, pure white, RAL 9010	81.0 x 52.5 x 44.5	System 55	515853332	
ST-AP 55-2*		Double-type frame, pure white, RAL 9010	152.0 x 81.0 x 44.5	System 55	515863332	
ST-AP 55-3*		Triple-type frame, pure white, RAL 9010	224.0 x 81.0 x 44.5	System 55	515873332	
Boxes for surface-mounting		For mechanical program switch PG-FST2 with Euro profile half-cylinder Single-type frame, white	100 x 80 x 65	Deutsche Solenoid	19142201170	

* no illustration





dormakaba AutoSwitch transponder

dormakaba AutoSwitch	Designation	Specification	Order No.
		The "active" transponder system sends a pulse to the control unit as soon as it enters the receiver range, which amounts to approx. 2.5 m. This system is especially suitable for areas where a manual operation of the system is to be excluded. Thanks to its range it is the perfect access control system for doors used by wheelchair users.	05102331332
	dormakaba AutoSwitch	Receiver/control unit, surface-mounted version, white	16571101175
		Programming-(Transponder-) key, yellow	16571201175
		Standard-(Transponder-) key, blue	16571301175

Infrared detectors

Light barriers	Designation	Specification	Order No.
	LB 03	To safeguard the passage area of sliding doors by detecting the presence of people and objects Counter light barrier comprising transmitter and receiver	05102331332
Active infrared detector	Designation	Specification	Order No.
	AIR 30/31 AIR 30-H/31	Active infrared system to safeguard the passage area and the secondary closing edges of sliding doors. Designed to detect the presence of people and objects Including background evaluation, black Including background suppression, black	16503601170 16503701170
	WH 30	Rain protection cover, black	16500901170
Crystal Presence	Designation	Specification	Order No.
	Crystal Presence	For improved protection of passage areas and secondary closing edges of sliding doors. Designed to detect the presence of people and objects Presence detection curtain for improved protection thanks to exactly adjustable detection range, black	16504301170
	System for ceiling mounting	For Crystal Presence, white	05094731332
Combined sensors	Designation	Specification	Order No.
	Activ8.2	To activate (open) and protect automatic sliding doors. This system is designed to substitute light barriers with the aid of an integrated active infrared function. This combined sensor opens sliding doors via radar and protects the main and secondary closing edges via an active infrared system. Direction recognition, black	16518301170
	Activ8.3-N	Direction recognition, self-monitoring, suitable for application on FST doors (fire and smoke doors), black	16555001170
	Jupiter	Direction recognition with cross-traffic suppression, black	16563201170
	Jupiter SE	Direction recognition with cross-traffic suppression, self-monitoring, suitable for application on FST doors (fire and smoke doors), black	16563301170

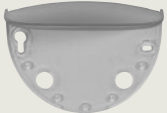
Radar motion detectors

Standard motion detectors	Designation	Specification	Colour	Order No.
 <p>Eagle</p>  <p>Merkur</p>  <p>System for ceiling installation Eagle</p>  <p>Rain protection cover Eagle</p>  <p>Special bracket Eagle</p>  <p>System for ceiling installation Merkur</p>	<p>The user-friendliness of automatic doors depends a lot on what kind of activator is used and its construction. The dormakaba sensor range combines the flexibility that is required for the different fields of application with reliability and the highest level of user friendliness. Furthermore it effectively detects moving people or objects in order to activate (open) automatic doors.</p> <p>Standard motion detectors</p> <p>Eagle 2 Standard</p> <p>Merkur M Standard</p> <p>Motion detectors with direction recognition Direction recognition for perfectly controlled opening and closing cycles.</p> <p>Eagle 1 Direction recognition</p> <p>Merkur Cross-traffic suppression with direction recognition</p> <p>Self-monitoring motion detector (FST application – for door with application in emergency exits and escape routes) Radar motion detector for doors in emergency exits and escape routes with self-monitoring function and electronics in redundant design</p> <p>Eagle 3-N Self-monitoring, direction recognition</p> <p>Merkur SE/R Self-monitoring, direction recognition with cross traffic suppression</p> <p>Accessories for Eagle detectors System for ceiling mounting Rain protection cover Infrared remote control to adjust all radar motion detectors Special bracket, for projections of up to 500 mm</p> <p>Accessories for Merkur-type detectors System for ceiling installation (Merkur)</p>	<p>black</p> <p>white</p> <p>silver</p> <p>black</p> <p>black</p> <p>white</p> <p>white</p> <p>silver</p> <p>black</p> <p>black</p> <p>white</p> <p>transparent</p> <p>black</p> <p>black</p> <p>white</p>	<p>16503201170</p> <p>16503203170</p> <p>16507502170</p> <p>16537501170</p> <p>16503101170</p> <p>16503103170</p> <p>16503102170</p> <p>16532201170</p> <p>1655161170</p> <p>1655163170</p> <p>1655162170</p> <p>16532201170</p> <p>16502901170</p> <p>05090731332</p> <p>16503001170</p> <p>19138903150</p> <p>05102231332</p>	



**Door
Hardware**



**Electronic
Access & Data**



**Mechanical
Key Systems**



Lodging Systems



**Entrance
Systems**



**Interior Glass
Systems**



Safe Locks



Service

dormakaba
International Holding AG
Hofwisenstrasse 24
CH-8153 Rümlang
T +41 44 818 90 11
info@dormakaba.com
www.dormakaba.com