



Art #, BTS 80F/EMB/FLB/BSR, (DHW), 05/2022 EN.
Subject to change without notice.

Contact Us
Info.ASEAN@dormakaba.com
www.dormakaba.com.sg



Door Hardware



Electronic Access & Data



Mechanical Key Systems



Lodging Systems



Entrance Systems



Interior Glass Systems



Safe Locks



Service

dormakaba Singapore Pte Ltd
12 Tukang Innovation Drive #04-01
Singapore 618303
T +65 6268 7633

dormakaba Malaysia Sdn Bhd
No. 3, Jalan TP 6
Taman Perindustrian UEP
47600 Subang Jaya
Selangor Darul Ehsan
T +603 8081 8009

dormakaba Philippines Inc.
Unit 102 RCI Building,
105 Rada St.,
Legaspi Village, Makati City, Philippines
T +632 8893 4077/78

dormakaba (Thailand) Limited
762/2 Room no. A258,
Rama 3 Road Bangpongpan,
Yannawa Bangkok 10120, Thailand
T +66 2059 2612

PT. dormakaba Access Indonesia
Jl. Ciputat Raya No. 335, RT. 002 RW. 007
Kebayoran Lama Utara, Kebayoran Lama Kota
Adm. Jakarta Selatan
DKI Jakarta 12240
T +62 21 2930 3762

dormakaba Vietnam Rep Office
Centec Business Center, Unit 002, Floor 4,
72-74 Nguyen Thi Minh Khai Street,
Ward 6, District 3, Ho Chih Minh City,
Vietnam
T +84 8 62 99 82 72

Floor spring BTS 80 F / EMB / FLB / BSR

Floor spring system for single-leaf and double-leaf doors.

The BTS 80 floor spring system fulfils your requirements in terms of practicality, convenience and security. It is also inconspicuous and suitable for doors weighing up to 300 kg.

The floor spring technology is fitted in the floor such that it is almost completely concealed from view. The BTS 80 floor spring system comes in 3 product variants: the BTS 80 F (floor springs for fire and smoke doors), the BTS 80 EMB (with electro-hydraulic hold-open), and the BTS 80 FLB (with fail-safe function). A wide range of accessories means it is easy to adapt the BTS 80 floor spring system to suit different door designs and functions. The system can also be used on double-leaf doors in conjunction with the BSR door coordinator.

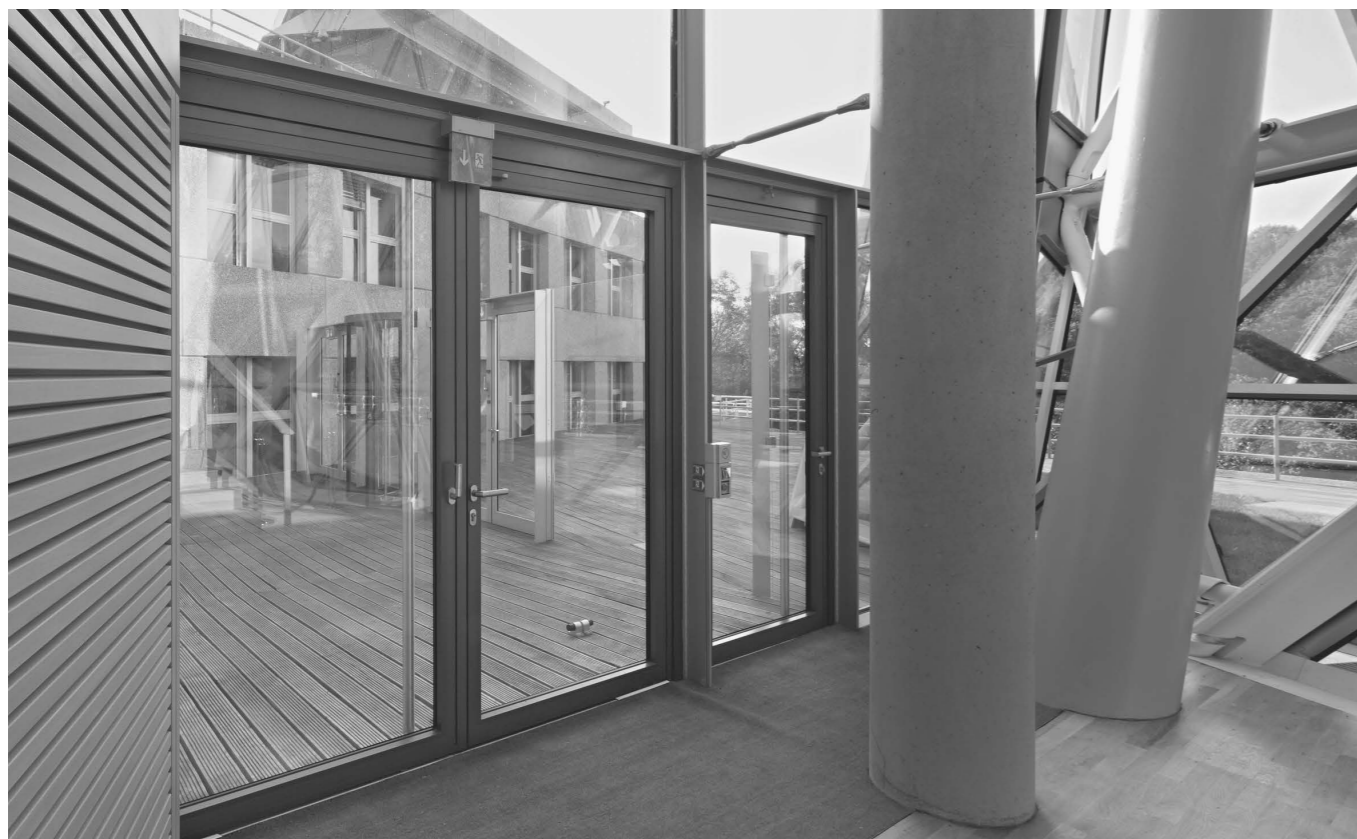

Contents

04	EBTS 80 F/EMB/FLB/BSR
04	Functions and features
06	BSR
06	door coordinator
08	BTS 80 System
08	Accessories
09	Supplied package contents and accessories overview
10	Specification texts



Our Sustainability Commitment

We are committed to foster a sustainable development along our entire value chain in line with our economic, environmental and social responsibilities toward current and future generations.

Sustainability at product level is an important, future-oriented approach in the field of construction. In order to give quantified disclosures of a product's environmental impacts through its entire life cycle, dormakaba provides Environmental Product Declarations (EPD), based on holistic life cycle assessments.

The full EPD is available for download at www.dormakaba.com.

Wide range of functions – Concealed installation – Assured quality

With concealed floor installation, dormakaba floor springs offer a perfect combination of freedom of design and maximum reliability with a wide range of functions. They meet the requirements for preventive fire protection and also the need for barrier-free user convenience and specific functions such as electrohydraulic hold-open and fail-safe. Longstanding design experience and ISO 9001 certified manufacturing guarantee high quality.

Advantages listed point by point

For trade

- Complete range for every need.
- Problem-free material planning due to consistent model assignment.
- Simple storage of accessories due to matching with the accessories for the dormakaba BTS.

For installers

- Effortless handling of individual requirements.
- Interchangeable spindles make it easy to adapt to structural conditions – even after installation.
- For heavy doors – up to 300 kg.

For planners

- Concealed installation.
- Functions tailored to requirements.
- Tried and tested, robust construction – can be loaded with a door weight of up to 300 kg.
- All types certified and quality-monitored or approved by the DIBt, Berlin.

For the end user

- Constant movement sequence regardless of temperature fluctuations.
- Comparatively easy door access due to maximum mechanical efficiency.
- Maximum security.

Data and features		BTS 80 F	BTS 80 EMB	BTS 80 FLB
Closing force General doors	≤ 1100 mm	EN 4	EN 4	EN 4
	≤ 1250 mm	EN 5	EN 5	EN 5
	≤ 1,400 mm	EN 6	EN 6	EN 6
Closing force Fire and smoke doors	≤ 1100 mm	EN 4	EN 4	EN 4
	≤ 1250 mm	EN 5	EN 5	EN 5
	≤ 1,400 mm	EN 6	EN 6	EN 6
Installation:	DIN-L	●	●	●
	DIN-R	●	●	●
	Double action doors ¹⁾	●	●	–
Closing time continuously adjustable using valve	●	●	●	
Latching action continuously adjustable using valve	●	●	–	
Backcheck, mechanical	●	●	–	
Delayed closing	–	–	–	
Electro-hydraulic hold-open, Continuous hold-open point, 75–180°	–	●	–	
Fail-safe 0–180°	–	–	●	
Weight in kg		7.1	7.7	7.7
Dimensions in mm	Length	341	341	341
	Depth	78	78	78
	Height	60	60	60
Power consumption in W		–	2.3	2.3
Operating voltage ± 15 % V DC		–	24	24
On-load factor in %		–	100	100
Door closers tested in accordance with BS EN 1154		●	●	●
Hold-open system tested in accordance with BS EN 1155		–	●	●
CE-identification for construction products		●	●	●

● yes – no ○ Option

¹⁾ Not approved for fire doors in Germany.

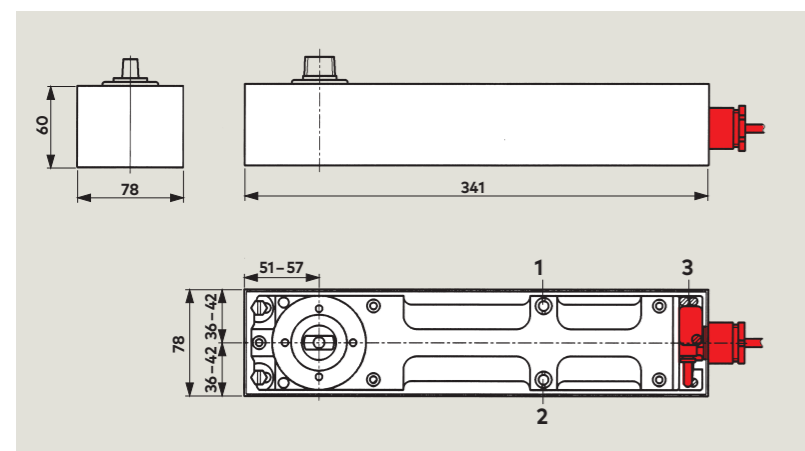

- 1 Valve for adjusting the closing time
- 2 Valve for adjusting the latching action (not BTS 80 FLB)
- 3 Connector with cable for EMB and FLB power supply

BTS 80 F

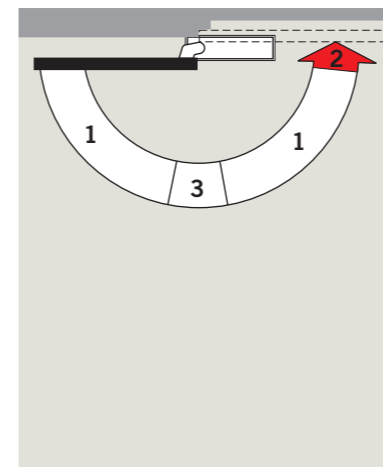

Floor spring

- 1 Fully controlled closing with adjustable speed
- 2 Adjustable latching action
- 3 Mechanical backcheck

Can be used on fire protection barriers

The BTS 80 F may be used on fire and smoke doors. The doors must be specifically designed for connection to the floor spring (pivot point offset between door hinges 36 mm). An additional certificate of suitability is also required for the specific fire or smoke door. For use on officially approved fire protection barriers the provisions of the respective approval certificates must be observed.

F Certificate of suitability

The BTS 80 F is tested and quality-monitored by the Material Testing Institute (MPA) in Dortmund in accordance with DIN EN 1154.

Example of left-handed design door, right-handed design door; mirror image

BTS 80 EMB

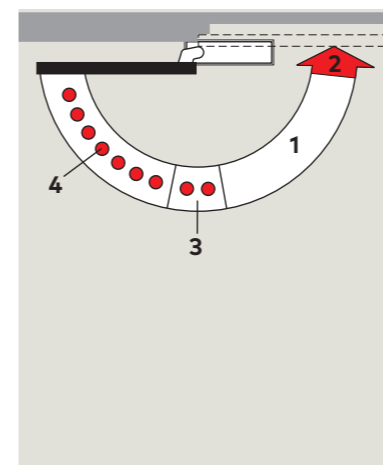

Floor spring with electromagnetic hold-open

- 1 Fully controlled closing with adjustable speed
- 2 Adjustable latching action
- 3 Mechanical backcheck
- 4 Hold-open area (Springback approx. 3°)

Can be used on fire protection barriers

The BTS 80 EMB may be used on fire and smoke protection doors. The doors must be specially designed for connection to the floor spring (pivot point offset between door hinges 36 mm). An additional certificate of suitability is also required for the specific fire and smoke door. The provisions of the respective approval certificates must be observed for use on officially approved fire protection barriers.

F Certificate of suitability

The BTS 80 EMB is approved for all well-known smoke detection systems by the German Institute for Building Technology [Deutschen Institut für Bautechnik] Berlin; Acceptance test mandatory.

Example of left-handed design door, right-handed design door; mirror image

BTS 80 FLB

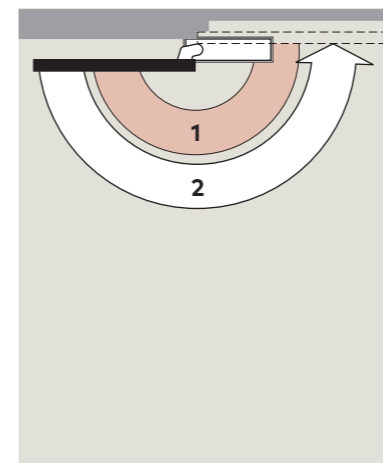

Floor spring with fail-safe (electromagnetic hydraulic spring lock)

- 1 Fail-safe area
- 2 Fully controlled closing in the event of an alarm or if the power supply is interrupted

Can be used on fire protection barriers

The BTS 80 FLB may be used on fire and smoke protection doors. The doors must be specifically designed for connection to the floor spring (pivot point offset between door hinges 36 mm). An additional certificate of suitability is also required for the fire or smoke door concerned. The provisions of the respective approval certificates must be observed for use on officially approved fire protection barriers.

F Certificate of suitability

The BTS 80 FLB is approved for all well-known smoke detection systems by the German Institute for Building Technology [Deutschen Institut für Bautechnik] Berlin; acceptance test mandatory.

Example of left-handed design door, right-handed design door; mirror image

BSR

Door coordinators

The BSR door coordinator ensures that the active door leaf always closes after the passive door leaf on double-leaf doors.

In the case of doors with full panic locks, the passive door leaf must be equipped with a carry bar.

F Certificate of suitability

The BSR has been tested by the State Materials Testing Office in Dortmund for use on double-leaf doors.

Certificate of suitability required for each fire and smoke door.

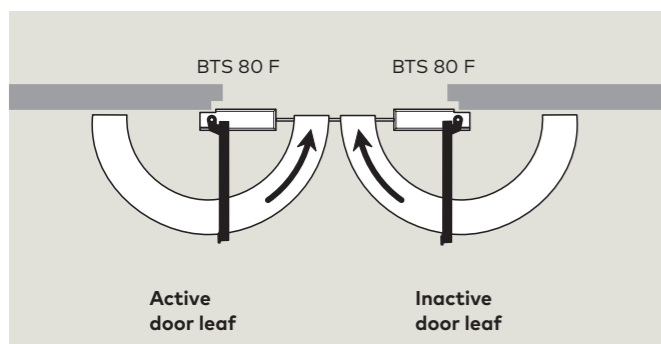
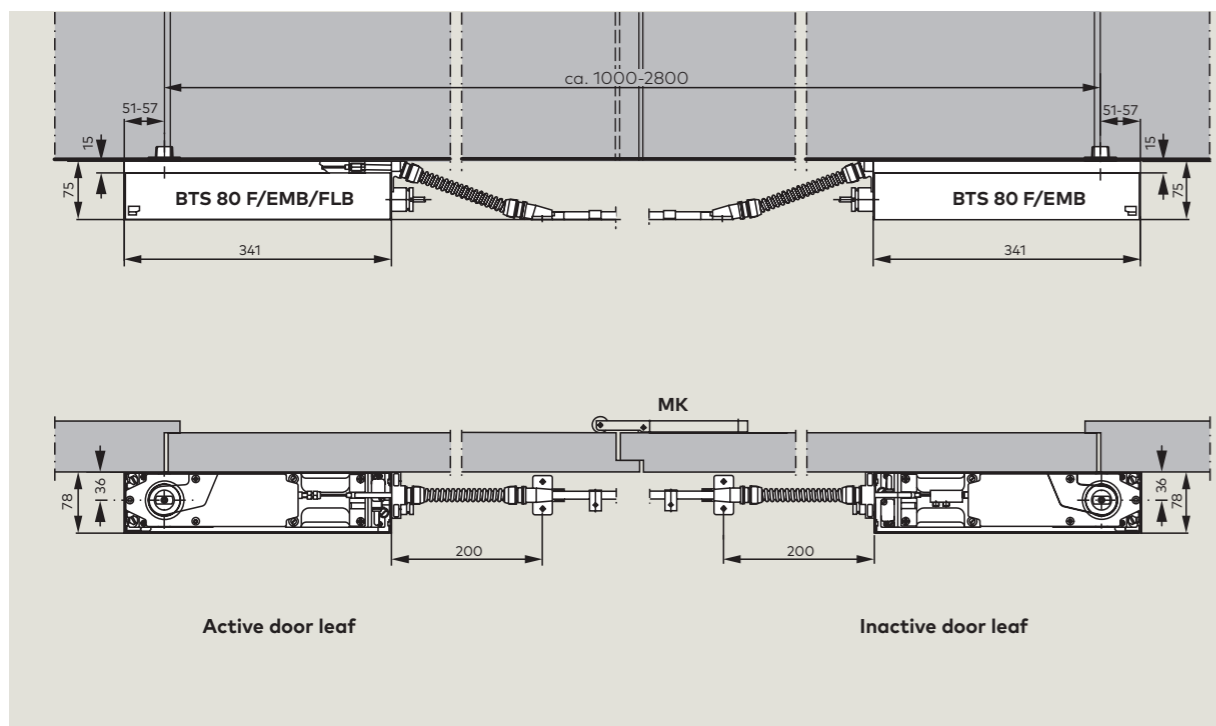

BSR

The BSR door coordinator operates independently of the hydraulic system of the door closer and consists of an active and a passive door leaf mechanism connected via a Bowden cable. The BSR door coordinator can be used for both LH and RH doors in combination with BTS 80 F/EMB/FLB floor springs.

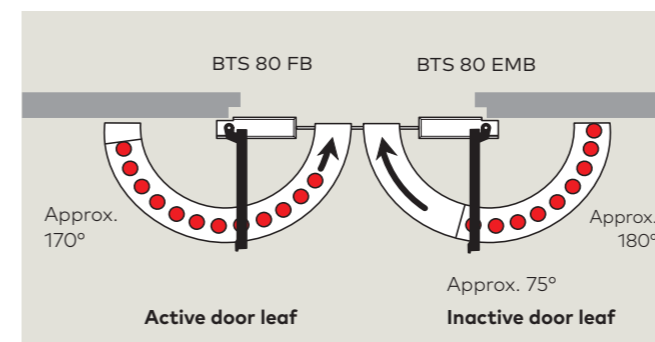

BSR EMB 1

This door coordinator enables both door leaves to be locked with just one locking device for the passive door leaf. The passive door leaf can be set to a hold-open point of between approx. 75° and 180° (springback approx. 3°). The active door leaf is fixed at any angle up to approx. 170° via the door coordinator.

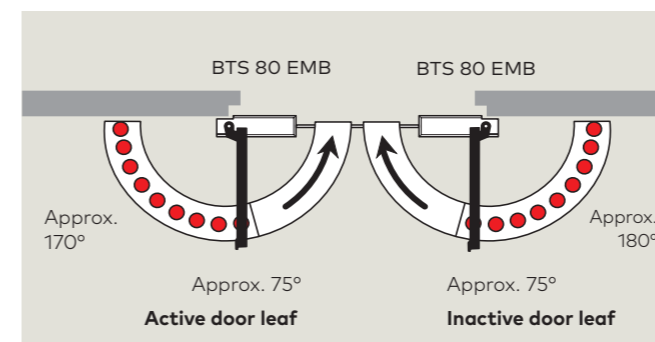

BSR EMB 2

With this door coordinator, the active door leaf can be locked independently of the passive door leaf. The hold-open points for both door leaves are between approx. 75° and 180° (spring back approx. 3°).

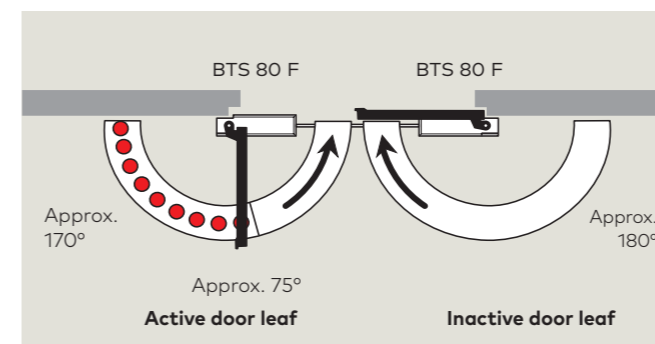

BSR EMB 1 G

Using this door coordinator, the active door leaf can be locked independently in special door constructions, e.g. fixed side leaf, narrow passive door leaf with asymmetrical doors, etc. The hold-open point is between approx. 75° and 180° (spring back approx. 3°).

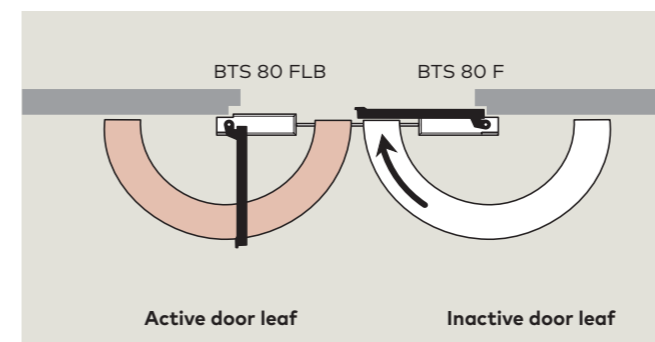

BSR FLB 1 G

This door coordinator with fail-safe on the active door leaf can also be used where doors need to remain freely movable but must close safely in the event of a fire.

Application and installation

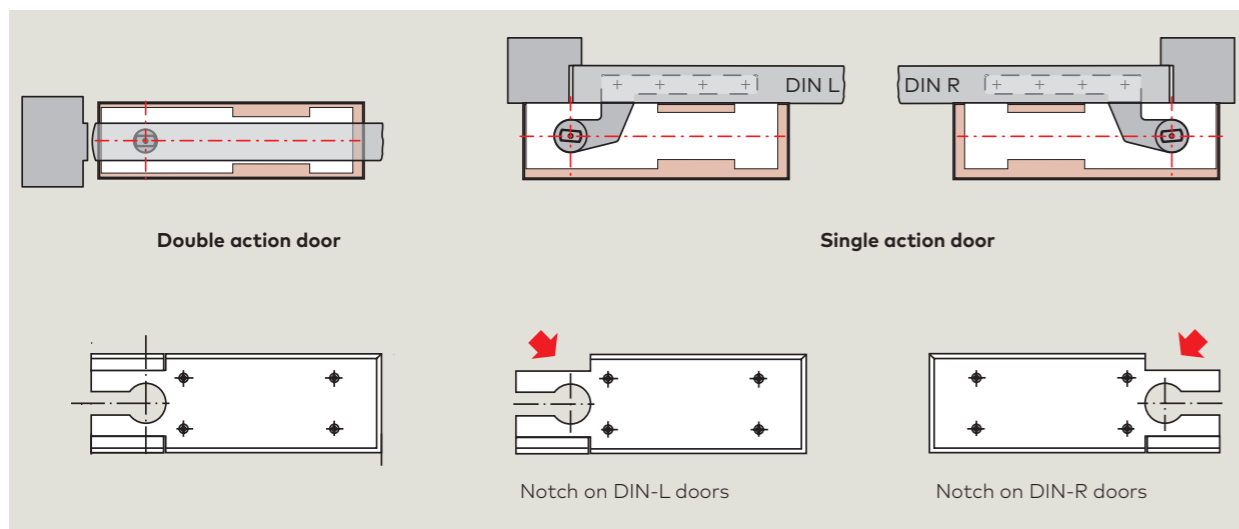

Accessories

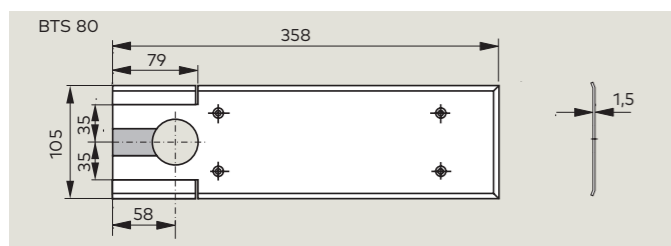

Universal cover plate

The universal cover plate can be used on both left-handed and right-handed design doors by simply ejecting the pre-punched corner parts. In the case of double action doors, it is mounted as delivered. The cover plate is optionally available in stainless steel or brass, brushed matt (material thickness 1.5 mm).

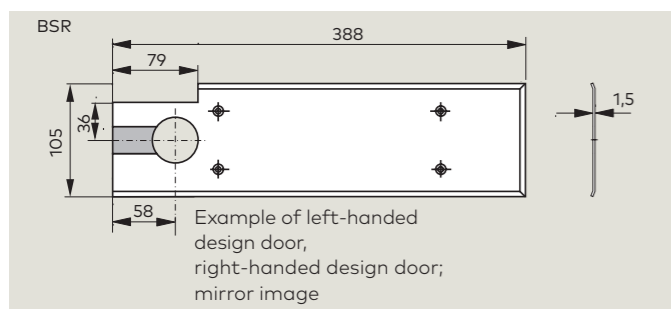

BSR cover plate

The cover plates for the BSR are available in left and right-handed designs. The cover plate is optionally available in stainless steel or brass, brushed matt (material thickness 1.5 mm).

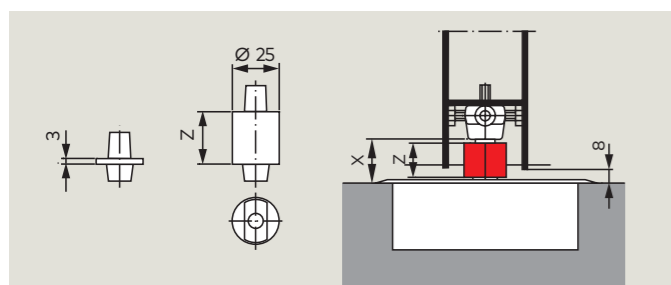

dormakaba 2300 sealing compound

For filling the cavities between the closer housing and the cement box to prevent the ingress of moisture (required for damp rooms etc. according to VOB).

For additional accessories such as **door levers and pivot hinges** see technical information "Accessories for dormakaba BTS floor springs".

Calculation of the required axle extension:
Extension = **X** - floor clearance (normally 8 mm)

Collar height **Z** of the extended spindles = axle extension + 3 mm (collar height of the normal spindle)

Product contents and accessories

Floor spring BTS 80 F/EMB/FLB Includes cement box without spindle	Spindles												Sealing compound 2300		
	Extension in mm														
	Normal	5	7.5	10	12.5	15	20	25	28	30	35	40		45	50
	45200401	45200402	45200403	45200404	45200419	45200405	45200406	45200407	45200414	45200408	45200409	45200410	45200411	45200412	
	45090086														

BTS 80 F																
EN 4	DIN-L DIN-R Pendulum ¹⁾	80220101 80220201 80220001	△	△	△	△	△	△	△	△	△	△	△	△	△	△
EN 5	DIN-L DIN-R Pendulum ¹⁾	80210101 80210201 80210001	△	△	△	△	△	△	△	△	△	△	△	△	△	△
EN 6	DIN-L DIN-R Pendulum ¹⁾	80230101 80230201 80230001	△	△	△	△	△	△	△	△	△	△	△	△	△	△

BTS 80 EMB																
EN 4	DIN-L DIN-R Pendulum ¹⁾	82224101 82224201 82224001	△	△	△	△	△	△	△	△	△	△	△	△	△	△
EN 5	DIN-L DIN-R Pendulum ¹⁾	82214101 82214201 82214001	△	△	△	△	△	△	△	△	△	△	△	△	△	△
EN 6	DIN-L DIN-R Pendulum ¹⁾	82234101 82234201 82234001	△	△	△	△	△	△	△	△	△	△	△	△	△	△

BTS 80 FLB																
EN 4	DIN-L DIN-R	82124101 82124201	△	△	△	△	△	△	△	△	△	△	△	△	△	△
EN 5	DIN-L DIN-R	82114101 82114201	△	△	△	△	△	△	△	△	△	△	△	△	△	△
EN 6	DIN-L DIN-R	82134101 82134201	△	△	△	△	△	△	△	△	△	△	△	△	△	△

Universal cover plate													
Stainless steel	46700000												
Brass, brushed matt	46700100	△											

¹⁾ Not approved for fire doors in Germany

BSR door coordinator		Floor spring			Spindles			Cover plates	
								Left-handed design 	
Versions	45700900	BTS 80 F	BTS 80 EMB	BTS 80 FLB	Normal	Extension in mm		Stainless steel 46700080	46700080
BSR	1 x	2 x			5	25		Brass, brushed matt 46700280	46700280
BSR-EMB 1	1 x	1 x	1 x		45200470	45200471	45200477	DIN-R 	
BSR-EMB 2	1 x		2 x		△	△	△	Stainless steel 46700081	
BSR-EMB 1 G	1 x	1 x	1 x		2 x	2 x	2 x	Brass, brushed matt 46700281	
BSR-FLB 1 G	1 x	1 x		1 x					△ 1 x left-handed design 1 x right-handed design

△ Accessories

Specification texts

BTS 80 F

Floor spring tested in accordance with BS EN 1154; with **CE** marking, fully hydraulically controlled closing cycle from 180°, adjustable latching action and backcheck.

Size

- EN 4
- EN 5
- EN 6

Version

- DIN left
- DIN right
- Double action (not approved for fire doors in Germany)

BTS 80 EMB

Floor spring tested in accordance with EN 1154, with **CE** marking, electro-hydraulic hold-open tested in accordance with EN 1155 and integrated pressure compensation for constant, adjustable, non-temperature sensitive hold-open for holding the door open between 75° and 180°.

With adjustable, fully hydraulically controlled closing time, adjustable latching action and backcheck, including cement boxes.

Operating voltage: 24 V DC

Power consumption: 2.3 W

Approved by the Deutsches Institut für Bautechnik (DIBt), Berlin (Germany), for use in hold-open systems.

Acceptance inspection mandatory.

BTS 80 FLB

Floor spring tested in accordance with EN 1154, with **CE** marking, with electrohydraulic fail-safe function between 0° and 180° door opening; closing action (non-powered) from 180°, adjustable, hydraulically fully controlled closing speed and backcheck (non-powered), including cement boxes.

Operating voltage: 24 V DC

Power consumption: 2.3 W

Approved by the Deutsches Institut für Bautechnik (DIBt), Berlin (Germany), for use in hold-open systems.

Acceptance inspection mandatory.

BTS 80 BSR

Floor spring tested in accordance with EN 1154, with **CE** marking, fully hydraulically controlled closing cycle from 180°, adjustable latching action, backcheck and door coordinator, which functions independently from the door closer hydraulics, tested in accordance with EN 1158; consists of an active leaf mechanism and a passive leaf mechanism, which are interconnected by a Bowden cable, including cement boxes, left-handed design and right-handed design applicable.

Approved by the German Institute for Building Technology, Berlin, in conjunction with fire and smoke doors

Size

- EN 4
- EN 5
- EN 6

Version

- DIN left
- DIN right

Accessories

- Universal cover plate (1.5 mm thick)
 - Stainless steel
 - Brass, brushed matt
- Spindle
 - Standard
 - ... mm extension
- Sealing compound

Make:

dormakaba BTS 80 F

Accessories

- Universal cover plate (1.5 mm thick)
 - Stainless steel
 - Brass, brushed matt
- Spindle
 - Standard
 - ... mm extension
- Sealing compound

Make:

dormakaba BTS 80 EMB

Accessories

- Universal cover plate (1.5 mm thick)
 - Stainless steel
 - Brass, brushed matt
- Spindle
 - Standard
 - ... mm extension
- Sealing compound

Make:

dormakaba BTS 80 FLB

Accessories

- Cover plate (1.5 mm thick)
 - Stainless steel
 - Brass, brushed matt
- Spindle
 - Standard
 - ... mm extension
- Sealing compound

Make:

dormakaba BTS 80 BSR

BTS 80 BSR-EMB 1

Floor spring tested in accordance with EN 1154, with **CE** marking, electro-hydraulic hold-open tested to EN 1155 on the passive door leaf, and integrated pressure compensation for constant, adjustable, non-temperature sensitive hold-open for holding the door open between 75° and 180°. With adjustable, fully hydraulically controlled closing speed, adjustable latching action, backcheck and door coordinator, which functions independently from the door closer hydraulics tested to EN 1158; consists of an active door leaf mechanism and a passive door leaf mechanism, which are interconnected by a Bowden cable, including cement boxes, left-handed/right-handed design applicable.

Operating voltage: 24 V DC

power consumption: 2.3 W

Approved by the Deutsches Institut für Bautechnik (DIBt), Berlin (Germany), for use in hold-open systems.

BTS 80 BSR-EMB 2

Floor spring tested in accordance with EN 1154, with **CE** marking, electro-hydraulic hold-open tested in accordance with EN 1155 on the passive and active door leaves, and integrated pressure compensation for constant, adjustable, non-temperature sensitive hold-open for holding the door open between 75° and 180°. With adjustable, fully hydraulically controlled closing time, adjustable latching action, backcheck and door coordinator, which functions independently from the door closer hydraulics tested in accordance with EN 1158; consists of an active door leaf mechanism and a passive door leaf mechanism, which are interconnected by a Bowden cable, including cement boxes, left-handed design and right-handed design applicable.

Operating voltage: 24 V DC

power consumption: 4.6 W

Approved by the Deutsches Institut für Bautechnik (DIBt), Berlin (Germany), for use in hold-open systems.

BTS 80 BSR-EMB 1G

Floor spring tested in accordance with EN 1154, with **CE** marking, electro-hydraulic hold-open tested in accordance EN 1155 on the active door leaf, and integrated pressure compensation for constant, adjustable, non-temperature sensitive hold-open for holding the door open between 75° and 180°. With adjustable, fully hydraulically controlled closing time, adjustable latching action, backcheck and door coordinator, which functions independently from the door closer hydraulics tested to EN 1158; consists of an active leaf mechanism and a passive leaf mechanism, which are interconnected by a Bowden cable, including cement boxes, left-handed design and right-handed design applicable.

Operating voltage: 24 V DC

power consumption: 2.3 W

Approved by the Deutsches Institut für Bautechnik (DIBt), Berlin (Germany), for use in hold-open systems.

BTS 80 BSR-FLB 1G

Floor spring tested in accordance with EN 1154, with **CE** marking, electro-hydraulic fail-safe on the active door leaf for door opening between 0° to 180°, closing action (non-powered) from 180°, hydraulically fully controlled closing time, adjustable backcheck (non-powered), door coordinator, which functions independently from the door closer, hydraulics, tested in accordance with EN 1158; consists of an active leaf mechanism and a passive leaf mechanism, which are interconnected by a Bowden cable, including cement boxes, left-handed design and right-handed design applicable.

Operating voltage: 24 V DC

power consumption: 2.3 W

Approved by the Deutsches Institut für Bautechnik (DIBt), Berlin (Germany), for use in hold-open systems. Acceptance inspection mandatory.

Size

- EN 4
- EN 5
- EN 6

Version

- DIN left
- DIN right

Make:

dormakaba BTS 80 BSR-EMB 1

Accessories

- Universal cover plate (1.5 mm thick)
 - Stainless steel
 - Brass, brushed matt
- Spindle
 - Standard
 - ... mm extension
- Sealing compound

Make:

dormakaba BTS 80 BSR-EMB 2

Size

- EN 4
- EN 5
- EN 6

Version

- DIN left
- DIN right

Make:

dormakaba BTS 80 BSR-EMB 1G

Size

- EN 4
- EN 5
- EN 6

Version

- DIN left
- DIN right

Make:

dormakaba BTS 80 BSR-EMB 2G

Accessories

- Cover plate (1.5 mm thick)
 - Stainless steel
 - Brass, brushed matt
- Spindle
 - Standard
 - ... mm extension
- Sealing compound

Make:

dormakaba BTS 80 BSR-FLB 1G

Accessories

- Cover plate (1.5 mm thick)
 - Stainless steel
 - Brass, brushed matt
- Spindle
 - Standard
 - ... mm extension
- Sealing compound

Make:

dormakaba BTS 80 BSR-FLB 1G