



TMS

TMS – Your interface to systematic security

With its TMS door management system, dormakaba is able to offer a new departure in the development of system component control. The objective: reliable, problem-free door functions adapted to each individual requirement from the simple single-door application to the networked system incorporating a multiplicity of door devices connected to the building management system.

The flexibility of the TMS door management system means that it can be used to activate SVP emergency escape locks with automatic locking action, and electrical swing door operators. It can also be readily combined with other facilities such as access control systems, intruder alarms, short-circuit TV/ video systems, etc. The TMS thus opens up the way to the creation and implementation of individualised solutions to suit your particular application.



Benefits at a glance

- Time and cost savings at the installation phase thanks to advanced bus technology and the simplest of cabling configurations
- Outstanding functionality with automatic detection and pre-parameterisation of the individual components
- Easy programming and re-programming
- Integrated timer
- Integrated access control
- Disable input for intruder alarms via I/O module
- VdS (property insurance association) compliant
- Bus integration with other installations such as building control systems
- LON, LAN, RS 232, OPC and ESPA interfaces
- Comprehensive documentation for fast and reliable fault analysis if this should be required
- All doors can be networked and thus centrally controlled
- System can be visualised and parameterised
- Flexible connectivity of external components
- Compact controller for complete, concealed installation

F Approval certification

dormakaba emergency exit systems meet the provisions of the German DIBt code of practice entitled "Requirements for electrical locking systems on doors in emergency escape routes" (EltVTR), and EN 13 637.

Content

Door Management System	TMS	
	System overview	4
Door terminal	TL-G	8
	TL-UP S55 for installation in standard device boxes	12
	TL-S Control and interface boards	16
Rettungswegzentralen	RZ TMS	18
	TMS Sets	20
Door locking device	TV 1xx DCW®	22
	TV 2xx DCW® Electromagnetic door locking device	26
	TV 5xx DCW®	30
Door Management System	I/O Modul DCW® Bus interface modules	32
	TMS Accessories	34
	TMS Connection diagrams	40
	TMS Safety information	47

DCW® = DORMA **C**onnect and **W**ork

System overview

Door management system as electrical locking system in emergency exit doors as per EltVTR and prEN 13637. The door functions are controlled by the TL-S TMS 2 control and interface board, or by emergency exit control RZ TMS 2. Integrated access control function with TMS-Soft / CODIC Card Soft / MATRIX software packages. Suitable for connection of various types of DCW® access control reader.

Both controls are designed for connection of max. 4 electronic keeps type TV xxx DCW®, key switches type ST 3x DCW®, interface board TL-S DCW® and other DCW® bus components.

Connection to a hazard alarm control panel and/or fire alarm control panel or a smoke detector for emergency unlocking via a floating contact is possible. DCW® system bus with component auto-identification and default parameterisation of all DCW® system devices.

Customised requirements can be programmed into the system via the or parameterising software TMS-Soft.

System visualisation and control via PC is also possible with the TMS-Soft package.

Several TMS can be networked via LON modules and LON gateways or LAN modules. Here, too, parameterisation, visualisation and control are performed via PC and TMS-Soft in the LON or LAN network. Integrated programmable short-time, long-time and permanent unlocking via key-operated momentary-contact control with parameterisable key actuating times and functions.

In the event of a power failure, the system is immediately locked. Following authorised unlocking, re-locking is performed automatically under short-timer control between 3 and 180 seconds, or under long-timer control between 3 and 120 minutes, parameterised via parameterisation software TMS-Soft.

Monitoring of the door-open time begins on expiry of the timers. The door open alarm can be triggered after an adjustable time lag of 5 to 180 seconds. The duration of the pre-alarm and main alarm is also programmable.

Where automatic re-locking has been activated, once the door has closed, immediate re-locking via the door contact can be initiated by programming the system accordingly.

Differentiated audible alarms to signal door open time exceeded (pre-alarm and/or main alarm), tamper attempt, system abuse, emergency open and fire alarm with local annunciation and automatic local alarm shutdown after 180 seconds.

The functions of the integrated key switch and also those of the external key switches type ST 3x DCW® are adjustable and definable.

Combination possible with SVP locks, automatic door operators, etc.

Components	System	TMS Standard TMS Standard +	TMS Universal TL	TMS Universal RZ	Special system for psychiatric security	
Terminal housing, emergency pushbutton		TL-G 3xx NT TL-G 5xx NT	TL-G 3xx TL-G 5xx	TL-NC S55 DCW®	TE 20	TL-NC S55 DCW®
Interface board		TL-S TMS 2	TL-S DCW®	integrated		-
Control unit		integrated		RZ TMS 2		RZ TMS 2
Power supply		integrated		integrated		integrated
Door locking device				TV 1xx DCW® TV 2xx DCW® TV 5xx DCW®		
Key switch			ST 32 DCW® ST 34 DCW®	TL-ST S 55	ST 32 DCW® ST 34 DCW®	TL-ST S 55
Emergency - escape lock		SVP 5000		-		
- escape lock with monitoring contact				SVP 4000		
- escape lock with monitoring micro-switches				SVP 6000		
-escape motor lock				SVP 2000		
Escape motor lock				SVP-S2x DCW® + SVP PR 12		
SVP lock accessories				SVP-SB anti-tamper fitting		
Cabling, cable loop				SVP-A 1000, KÜ/KS		
Further options				CODIC Card access control reader AS/BL, TG/TE DCW® I/O module LON module, LON gateway LAN modules TMS-Soft		

Data and features

	TMS Standard	TMS Universal
Opening of door in emergency via emergency pushbutton	●	●
Short-time unlocking, adjustable (3–180 sec)	● ①	● ①
Long-time unlocking 3–120 min.	● ①	● ①
Long-time unlocking with audible acknowledge signal	●	●
Permanent unlocking with audible acknowledge signal	●	●
“Door open” monitoring (1–180 sec)	● ①	● ①
Pre-alarm	● ①	● ①
Main alarm	●	●
Immediate re-locking after door closure	①	①
Lever handle pre-alarm	● ①	● ①
Differentiated visual and audible status signals	●	●
Bi-directional escape door terminal inside/door terminal outside	–	○
Operation with panel module (TE 20) without local door terminal	–	○
Automatic re-activation after power failure	●	●
Automatic locking of the emergency escape lock	●	●
Automatic re-activation by emergency escape lock	● ①	● ①
Mechanical sequential control of the emergency escape lock	●	●
Electrical sequential control of the emergency escape lock	–	○
Emergency unlocking by fire alarm system, building control system, smoke detector, sprinkler system, etc.	●	●
Passage from inside to outside via door terminal	●	●
Passage from outside to inside via key switch	○ ①	○ ①
Passage from inside to outside or outside to inside via lock	①	●
Anti-tamper monitoring, TL door terminal	●	●
Anti-tamper monitoring, TV electronic keep/door locking device	●	●
Integrated differential anti-tamper circuit/bus monitoring function	●	●
Alarm duration limit	● ①	● ①
Pre-alarm/Silent alarm	○	● ①
Connection to 230V AC	●	●
Access control	○	○
Actuation control logic for automatic door operators	●	●
Signal to intruder alarm/Intruder alarm disable input	①	①
Connection of external alarm devices	○	●
Remote monitoring, remote control	○	○
Remote unlocking of the emergency escape lock	○	○
Integrated inputs/outputs (of which floating)	2 / 2 (2)	2 / 2 (2)

● Standard ● Selectable/programmable ○ Option – Not available

System Examples

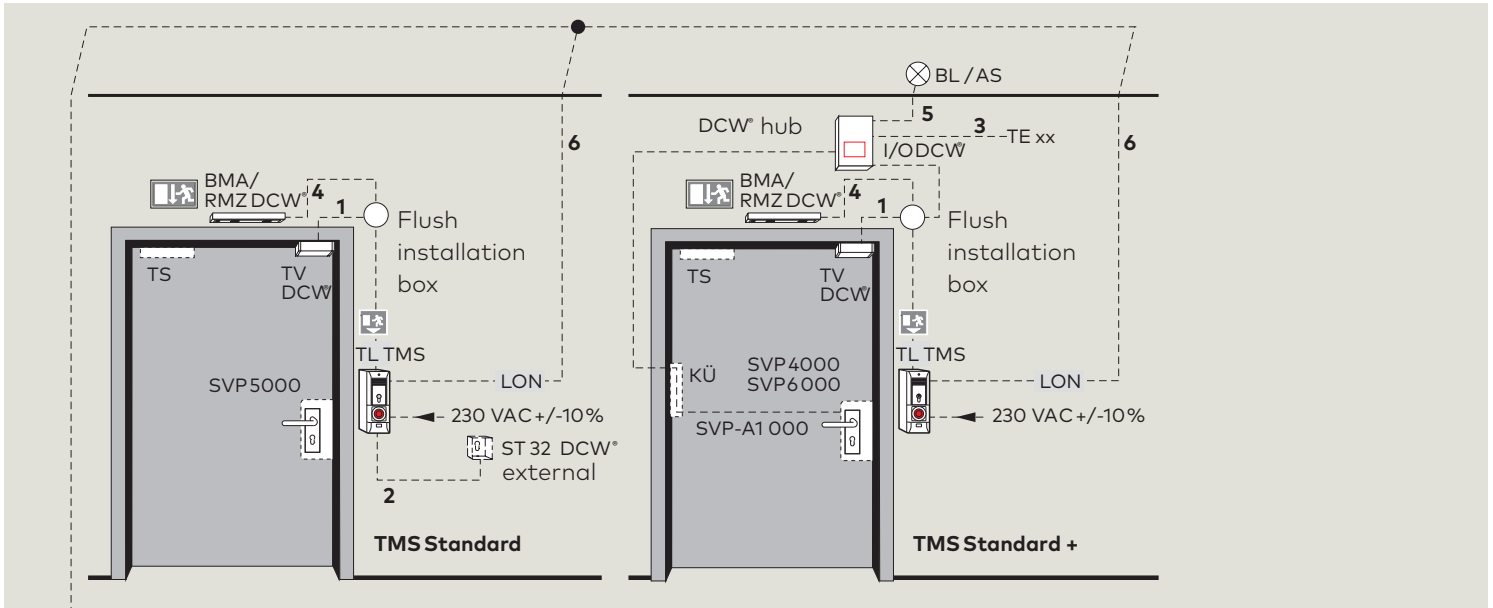

TMS Standard,
anti-tamper monitoring contact,
parameters freely configurable via PC

TMS Standard +,
anti-tamper monitoring contact, unlocking via lock cylinder
of the SVP, parameters freely configurable via PC

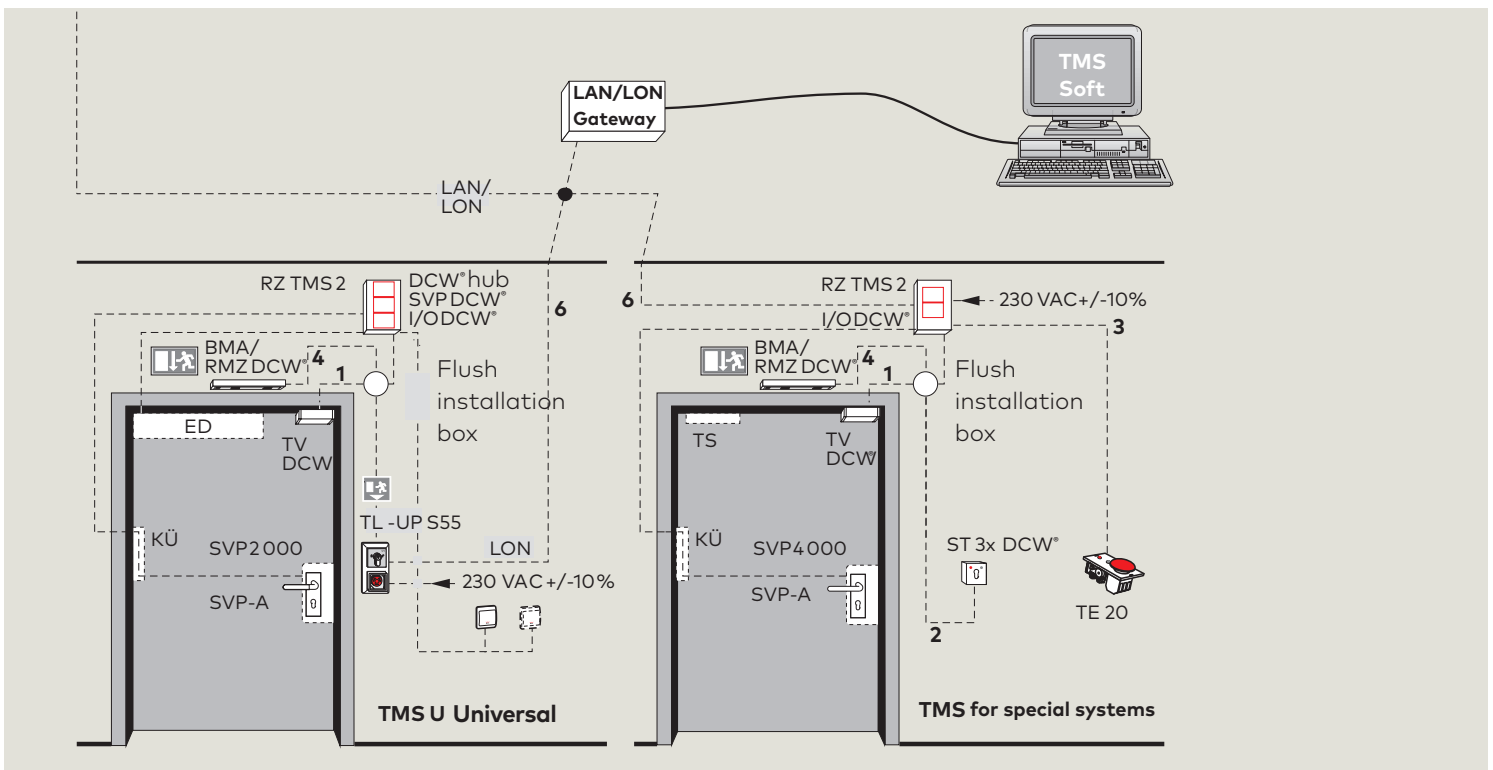

TMS Universal Design,
anti-tamper monitoring contact,
unlocking via lock cylinder of the SVP
or access control reader, parameters freely
configurable via PC

TMS without local release,
anti-tamper monitoring contact, unlocking
via lock cylinder of the SVP or access control
reader, release via central control panel,
parameters freely configurable via PC

Recommended cabling

Mains feeder			NYM-I 3 x 1,5
1	TL-TMS	↔	TV 1xx DCW [®] 4 x 2 x 0,8
2	TL-TMS	↔	ST 3x DCW [®] 2 x 2 x 0,8
3	TL-TMS	↔	TE xx* 2 x 2 x 0,8
4	TL-TMS	↔	RMZ DCW [®] 2 x 2 x 0,8
5	TL-TMS	↔	BL* 2 x 2 x 0,8
6	LON-module		LON-gateway 2 x 2 x 0,8

* via DCW[®] I/O module

TL-G Door terminal

With improved ergonomics and an abundance of innovative detail solutions, the TL-G NT door terminal offers more safety in an emergency plus optimum protection against access abuse.

The control and interface board allows control of all the door functions via a simple yet highly efficient bus technology.

The terminal can also be supplied without a power pack for connection to an RZ TMS 2 emergency exit control or an external power supply system.

Technical data Power supply unit

Power supply	230 V AC, ± 10% or 24 V DC by others
Output voltage	24 V DC
Output current, max.	1 A
Temperature range	- 20° bis + 50 °C

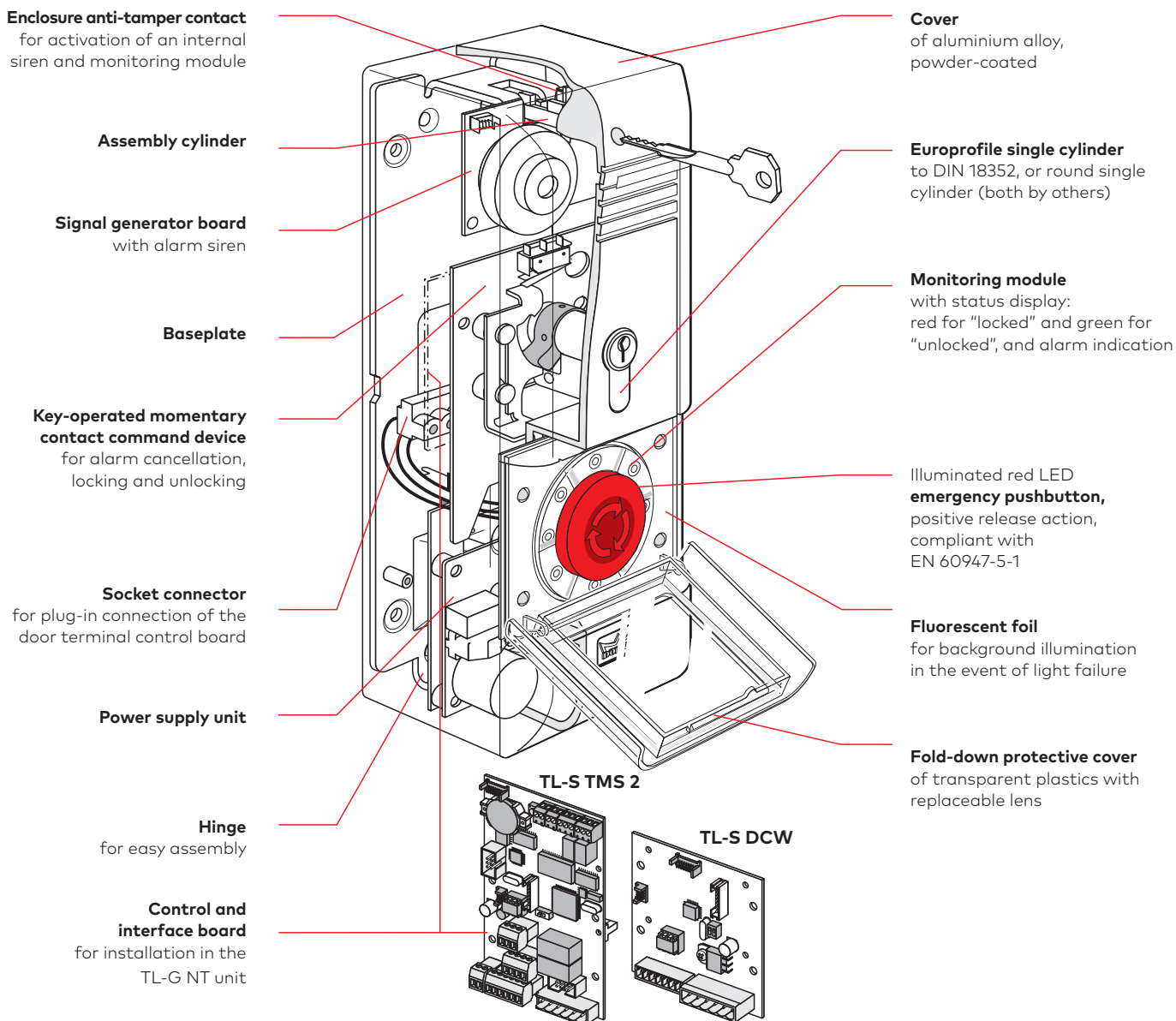

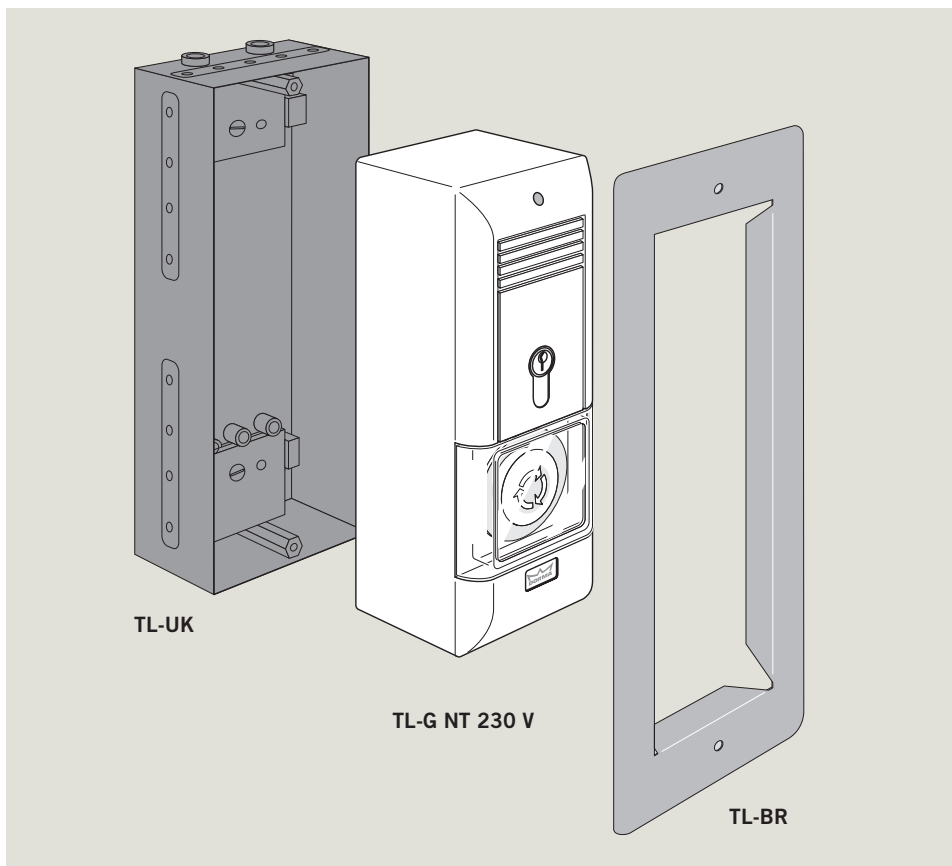

The door terminal is designed for surface mounting or, when combined with the TL-UK flush-mounting recess box and TL-BR frame surround, can also be installed as a concealed unit.

Note

According to the code of practice entitled "Requirements for electrical locking systems on doors in emergency exits and escape routes" (EltVTR) issued by the German Institute for Building Technology (DIBt), Berlin, the emergency push-button for release/emergency opening of the door must not be installed at a height of more than 1200 mm above finished floor level. A height of 850 mm is recommended.

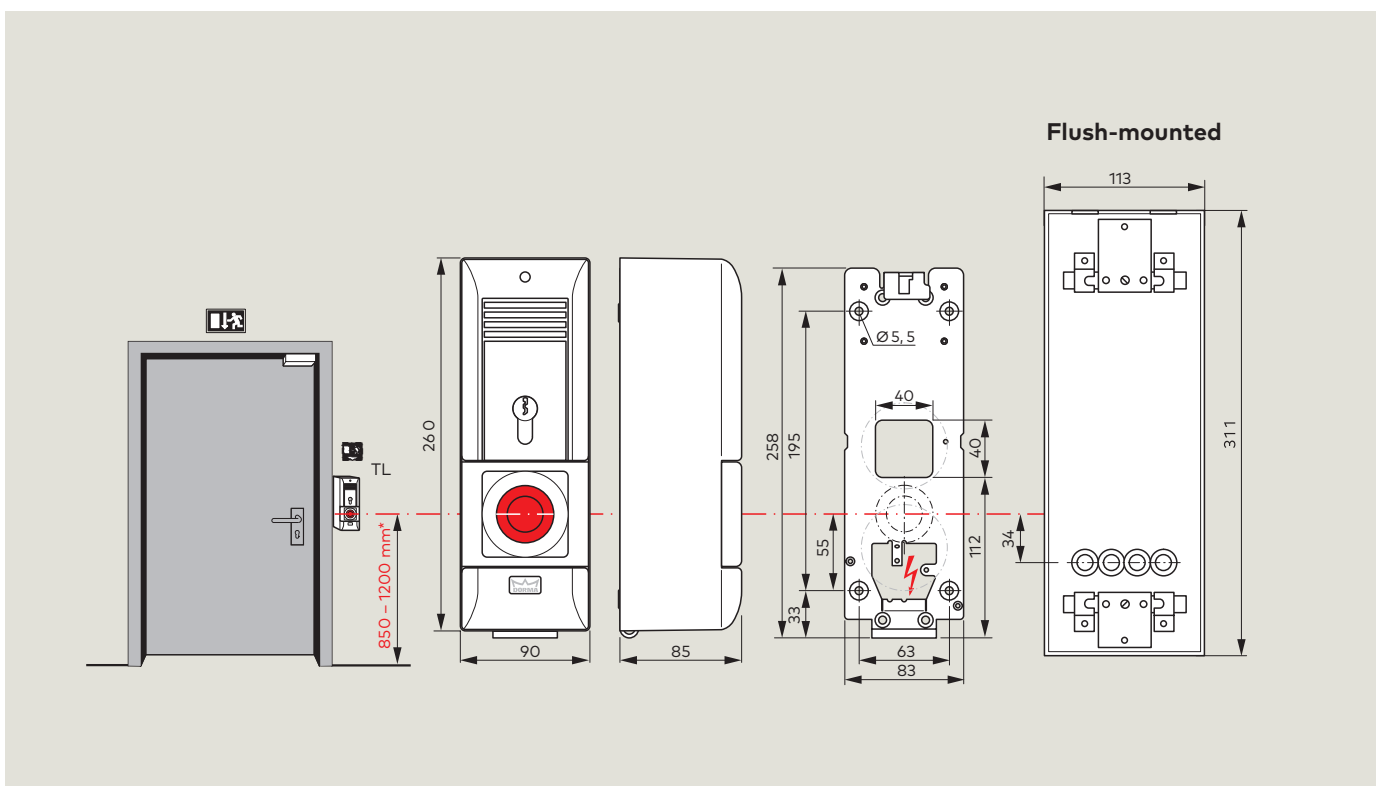

Product description

Order No.

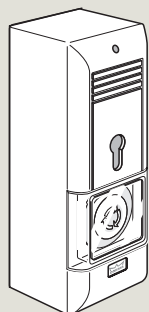
L-G 3xx / 5xx door terminal housing for installation of TL-S control and installation boards

Anti-tamper door terminal of powder-coated aluminium alloy, degree of protection IP40, for mounting TL-S TMS control and interface board, with LED-illuminated red emergency pushbutton per EN 60947-5-1, positive opening action, and integrated alarm siren with adjustable volume >100 dB. High-intensity illuminated emergency pushbutton surround with visual indication of the lock status and visual alarm by yellow flashing light in the event of tamper or authorised/valid operation of the emergency pushbutton. Very easy fitting of the terminal top section and bottom section by means of assembly cylinder accessible from the front, and a hinged upper section. Lockable hinged emergency pushbutton cover with anti-tamper contact and transparent lens of non-splinter breakable safety glass. Breakable safety glass with protective film as option. Integrated key switch and momentary contact control mechanism. Dimensions (W x H x D) approx. 90 x 260 x 84mm

TL-G 3xx / 5xx NT with integral power supply unit

Prepared for europrofile single cylinder by others to DIN 18252, (locking cam centre 30–32.5 mm, overall length 40.5–43.5 mm)

TL-G 320 NT green (sim. to RAL 6001)

56310320

TL-G 311 NT white (sim. to RAL 9016)

56310311

TL-G 304 NT stainless steel finish

56310304

TL-G 399 NT special colour

56310399

Prepared for 22 mm Ø round single cylinder by others

(locking cam centre 30–32.5 mm, overall length 40.5–43.5 mm)

Locking cam position bottom left (max. 45°)

TL-G 520 NT green (sim. to RAL 6001)

56310520

TL-G 511 NT white (sim. to RAL 9016)

56310511

TL-G 504 NT stainless steel finish

56310504

TL-G 599 NT special colour

56310599

TL-G 3xx / 5xx without power supply unit

Prepared for europrofile single cylinder by others to DIN 18252, (locking cam centre 30–32.5 mm, overall length 40.5–43.5 mm)

TL-G 320 green (sim. to RAL 6001)

56010320

TL-G 311 white (sim. to RAL 9016)

56010311

TL-G 304 stainless steel finish

56010304

TL-G 399 special colour

56010399

Prepared for 22 mm Ø round single cylinder by others

(locking cam centre 30–32.5 mm, overall length 40.5–43.5 mm)

Locking cam position bottom left (max. 45°)

TL-G 520 green (sim. to RAL 6001)

56010520

TL-G 511 white (sim. to RAL 9016)

56010511

TL-G 504 stainless steel finish

56010504

TL-G 599 special colour

56010599

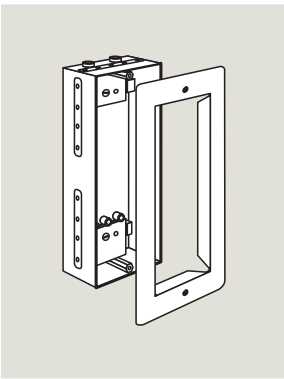
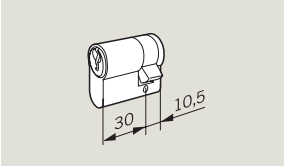
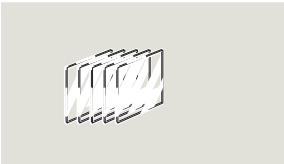
Product description	Order No.
	56510512
<p>TL-UK Zinc-plated flush-mounting recess box for installation of the door terminal, with attachment collars as wall anchors. Adjustable baseplate for compensation of vertical mounting tolerances. Prepared for cable entry at the front and rear. Dimensions (W x H x D) approx.: 113 x 311 x 77 mm</p>	
<p>TL-BR Surrounding trim, height-adjustable for adaptation to the installation depth. Dimensions (W x H x D) approx.: 130 x 331 x 4 mm</p> <ul style="list-style-type: none"> <input type="checkbox"/> TL-BR 08 yellowish green, fluorescent <input type="checkbox"/> TL-BR 11 white, powder-coated (sim. to RAL 9016) <input type="checkbox"/> TL-BR 04 stainless steel finish 	56510408 56510411 56510404
	56510300
<p>TL-Z 03 Europrofile single cylinder with 3 keys, with adjustable locking cam, fits in TL-G terminals, TE panel modules, ST key switches, sheet steel enclosures of RZ 12 N, NT 1224 N, SVP-S 25. (Not available for keyed alike or master key systems)</p>	
	56510400
<p>TL-Z 04 Replacement lens for emergency pushbutton cover TL-G 3xx/5xx Breakable safety glass with protective film Pack of 5</p>	

System 55 design terminal

The design terminal for installation in the equivalent of two standard device boxes can be effectively matched to and combined with the most common switch and control devices incorporated in the System 55 ranges offered by manufacturers such as GIRA, Berker, Merten and Jung. The terminal also comes with adapters for incorporation in other systems.

The emergency pushbutton unit carries on glowing at a high intensity after operation and features an annunciator module to indicate the system condition.

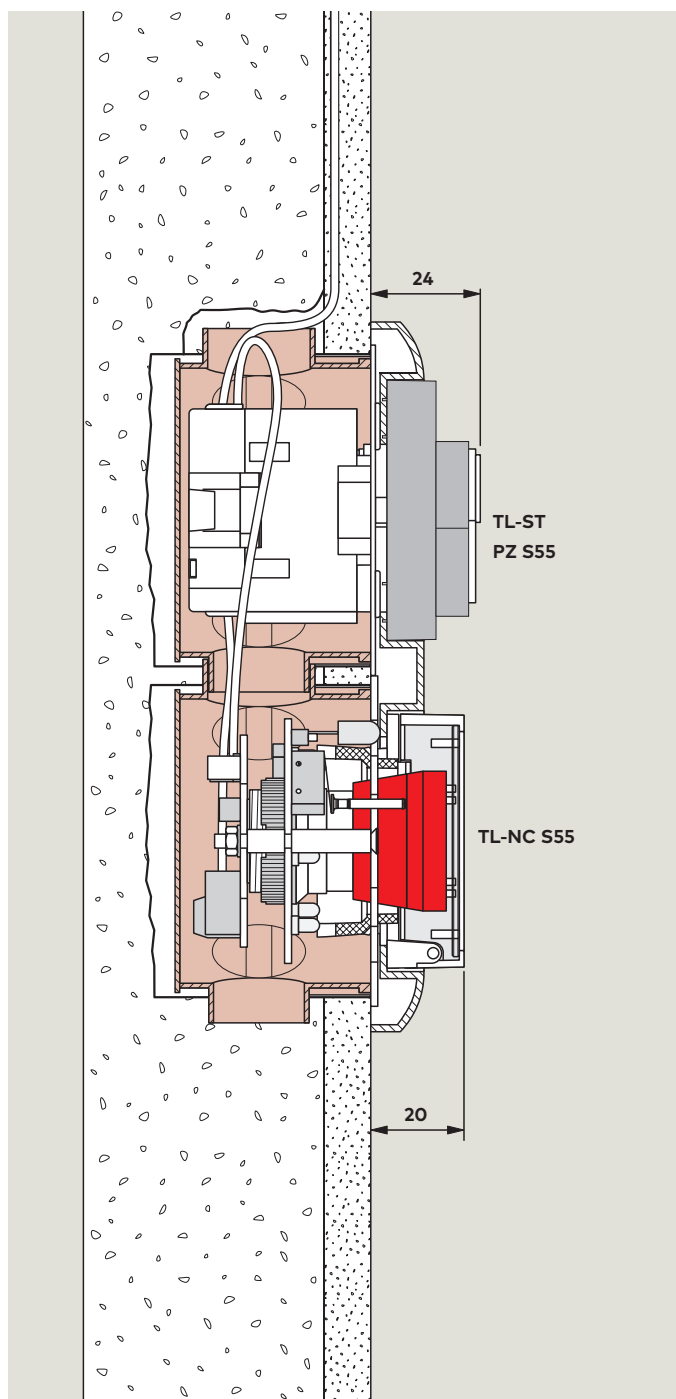

Technical data TL-NC S55 DCW®

Power supply	24 V DC, ± 10% stabilised
Current input, max.	75 mA 90 mA in alarm mode

Terminal assignment and functions

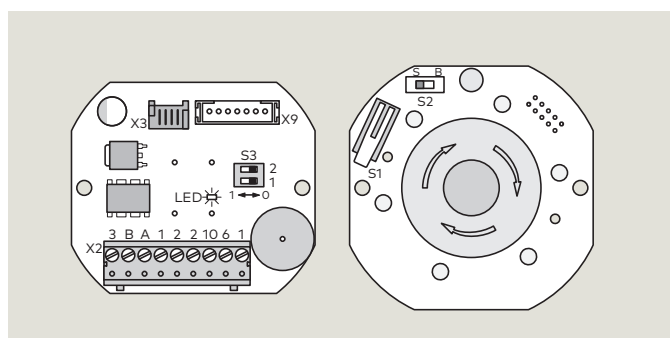

- X3** Connection to the key switch
- X9** Connection to the firmware programming system
- S1** Anti-tamper contact
- S2** B = Normal operation (anti-tamper contact activated)
S = Service mode (anti-tamper contact de-activated)
- S3** Micro-switches (DIP) for setting the device address:

Switch	Address	
1	0	2
0	0	1
1	0	2
0	1	3
1	1	4

- X2**
 - 1 ⊕ → +
 - 6 ⊖ → -
 - 10 ⊕ → +24 V DC
 - 3 ⊕ ⊥ GND
 - B ⊕ ↔ DCW®-Bus
 - A ⊕ ↔
 - 1 ⊕ ← +24 V DC
 - 2 ⊕ →
 - 2 ⊕ →
- External alarm siren (24 VDC; max. 40 mA)
- Emergency pushbutton operated (max. 0.55 mA)
- DCW®-Bus
- NC contact, emergency pushbutton ("Emergency Stop" circuit), contact rating max. 42 VDC; 0.55 A

- LED DCW®-Bus**
- LED on** Bus connection OK
- LED off** No power or no bus connection

Product description

Order No.

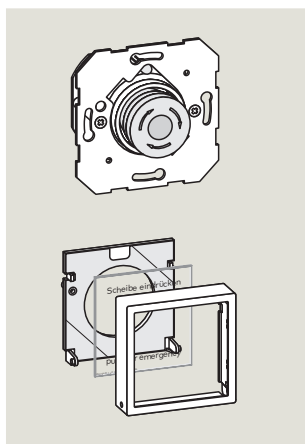
**TL-UP System 55 door terminal**

Door terminal for installation in standard device boxes (62 mm deep) to DIN, comprising: emergency pushbutton/controller unit TL-NC UP S55 and key-operated pushbutton TL-ST S55 for connection to emergency exit control unit RZ TMS 2 or TL-S TMS 2.

TL-NC S55 Emergency pushbutton/controller

With LED-illuminated, red emergency pushbutton corresponding to EN 60947-5-1, with positive opening action, brightly lit emergency pushbutton surround with optical indicator of the lock status (unlocked = green, locked = red); visual alarm provided by yellow flashing light to signal tamper/sabotage attempts and emergency pushbutton operation; audible alarm via integral alarm siren with parameterisable loudness volume. Anti-tamper emergency pushbutton cover with glass lens of shatter-proof safety glass. All cover trims from the System 55 switch range and stainless steel unit with adapter frames can be used.

56330601

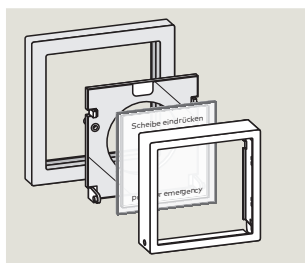
**TL-Z N JUNG**

Adapter set for System 55 emergency pushbutton

- TL-Z N JUNG LS 990** alpine white
- TL-Z N JUNG ES** stainless steel

56399901

56399902

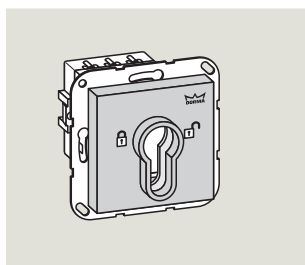
**TL-ST PZ S55**

Key switch for emergency exit control, for europrofile single cylinder by others to DIN 18252, locking cam centre 30-32.5mm, overall length 40.5-43.5mm, locking cam position left (90°)

- TL-ST S55 W** white
- TL-ST S55 S** silver
- TL-ST S55 A** anthracite

56330710

56330701

56330715

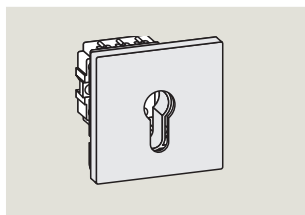
**TL-ST JUNG**

Key switch for emergency exit control, for europrofile single cylinder by others to DIN 18252, locking cam centre 30-32.5mm, overall length 40.5-43.5mm, locking cam position left (90°) for integration in JUNG range of flush-flat switches.

- TL-ST JUNG LS 990** alpine white
- TL-ST JUNG ES** stainless steel

56330720

56330721

TL-S – Control and interface board

Technical data TL-S TMS 2

Power supply	24 V DC +15/-5% stabilised
Current input, max. (installed in TL-G)	90 mA 110 mA in alarm mode
Contact rating	24 V DC, 0,5 A inductive 1,0 A ohmic

Terminal assignment and functions TL-S TMS 2

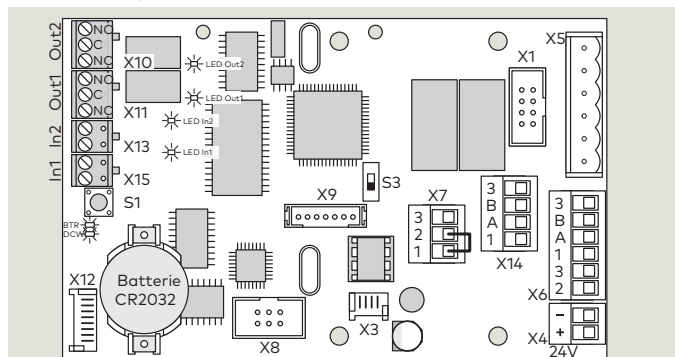

Description TL-S TMS 2

- X1** Connection to expansion module ZM 208 TMS
- X3** Connection to internal key switch/momentary contact device
- X4** Power supply 24 V DC, ± 10%
- X5** Connection to emergency pushbutton
- X6** Connection to TV/DCW®
- X7** External emergency pushbutton/smoke detector
- X8** PC interface RS 232/LON adapter/LAN adapter
- X9** Connection to the firmware programming system
- X10** Out 2
- X11** Out 1
- X12** Connection to TL-OM/lighting module
- X13** In 2
- X14** Connection to external DCW® devices
- X15** In 1

Terminal assignment TL-S TMS 2

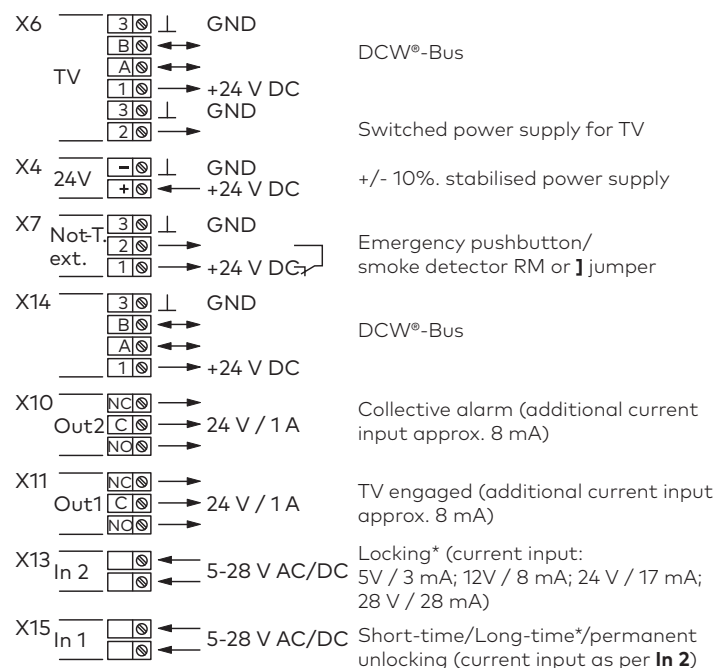

* or freely configurable via TMS-Soft 4.xx

Technical data TL-S DCW®

Power supply	24 V DC, ± 10% stabilised
Current input, max.	75 mA 90 mA in alarm mode

Terminal assignment and functions TL-S DCW®

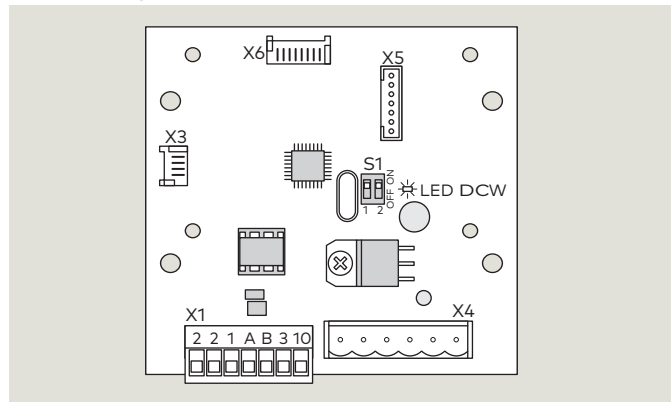

Description TL-S DCW®

- X1** Connection to TL-S TMS 2 or RZ TMS 2
- X3** Connection to internal key switch/momentary contact device
- X4** Connection to emergency pushbutton
- X5** Connection to firmware programming system
- X6** Connection to TL-OM/lighting module
- S1** Micro-switches (DIP) for setting the device address:

Switch	Address
1 1 2	0 0 1
1 0 2	1 0 2
0 1 3	0 1 3
1 1 4	1 1 4

Terminal assignment TL-S DCW®

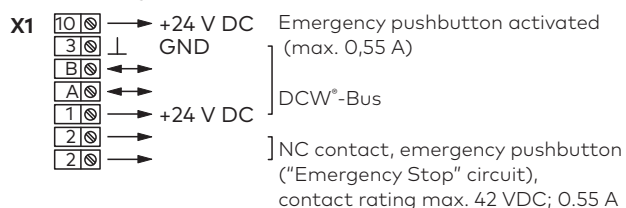

LED DCW®-Bus
LED on Bus connection OK
LED off No power or no bus connection

Product description

Order No.

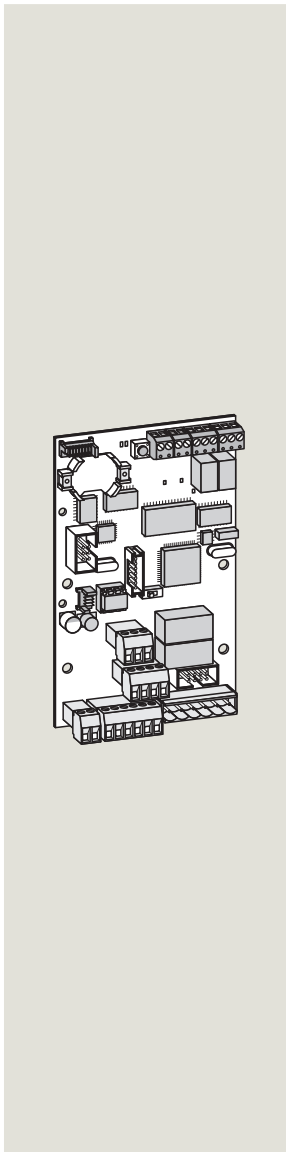

TL-S TMS 2

Control and interface board with integrated dual-port I/O module for installation in TL-G 3xx/5xx NT and TL-G 3xx/5xx terminal housing. Two opto-coupler inputs (interface connection with signals of 5 – 30V AC/DC) for external actuator control. Two floating outputs for activation of external components or other output signals. Integrated short-time, long-time and permanent unlocking via key-operated momentary contact device with programmable and parameterisable key operating times and functions. DCW® system bus with automatic device detection and default parameterisation of all DCW® system components; customer-specific requirements programmable via configuration software TMS-Soft from Version 4.x. Control, visualisation and parameterisation of all TMS DCW® security systems via customer's PC or mobile PC. Networking effected using the two-wire bus technique (LON FTT10A) or via LAN bus. Control, visualisation and parameterisation of up to 1,000 dormakaba door management systems (or more) via LAN or LON interface and LON adapter card. Process: LON Explicit Message, LAN TCP/IP. Control and interface board designed for connection of max. 4 door locking devices type TV 1xx DCW® and key switches type ST 3x DCW®, plus further DCW® bus devices. Suitable for connection of a hazard alert panel (GMA) and/or fire alarm panel (BMA) or smoke detector RM or RS DCW® for emergency unlocking via floating contact/DCW® bus. Integrated access control function via TMS-Soft/CODIC Card Soft. Various DCW® compatible access control readers can be connected. Power failure leads to immediate locking. Automatic re-locking after authorised unlocking event adjustable between 3 and 180 seconds at short-timer control or between 3 and 120 minutes at long-timer control via configuration software TMS-Soft from Version 4.x. Once the timers have run down, open-time monitors are enabled. Door open alarm can be delayed for between 5 and 180 seconds. Duration of pre-alarm and main alarm programmable. The system can also be programmed to perform immediate locking via door contact, with automatic relocking system activated. Differentiated audible alarm signals to indicate door open time exceeded (pre and/or main alarm), sabotage, tamper attempt, emergency open and fire alarm with local alarm and automatic local alarm switch-off programmable up to 180 seconds. Configurable alarm and signal loudness volumes. Anti-tamper bus cabling with sabotage monitoring. Adjustable and definable functions of the integrated key switch and also the external key switch ST 3 x DCW®.

Power supply: 24 V DC, ± 10%
 Current input max.: 65 mA
 90 mA in alarm mode
 Contact rating: 24 V DC, 0.5 A inductive
 1.0 A ohmic

56330101

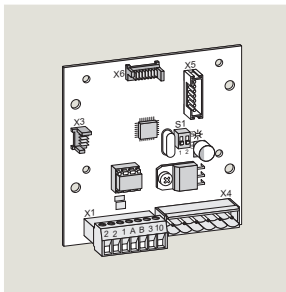

TL-S DCW®

Terminal interface board for installation in TL-G 3xx/5xx terminal housing and connection to control unit types TL-S TMS 2 or RZ TMS 2 via dormakaba system bus DCW®. Up to 4 TL-S DCW® boards can be connected via the system bus. Parameters, e.g. adjustable and definable functions of the integrated key switch and of the TL-S TMS 2 or RZ TMS 2 functions are automatically transferred.

Power supply: 24 V DC, ± 10%
 via DCW® system bus
 Current input max.: 65 mA
 85 mA in alarm mode

56330201

RZ TMS – Emergency exit control

With the RZ TMS 2 emergency exit control unit, dormakaba has enhanced its ability to respond to different structural situations. Consequently, you can choose between a control unit and power pack in the door terminal, or the same unit installed in a separate emergency exit control unit. All the important system components are already integrated and can be augmented for significant expandability.

Technical data	
Power supply	230 V AC, ± 10%
Rated input current	0,35 A
Output voltage	24 V DC, ± 10%
Rated output current max.	1,5 A
Temperature range	- 20 to + 50 °C

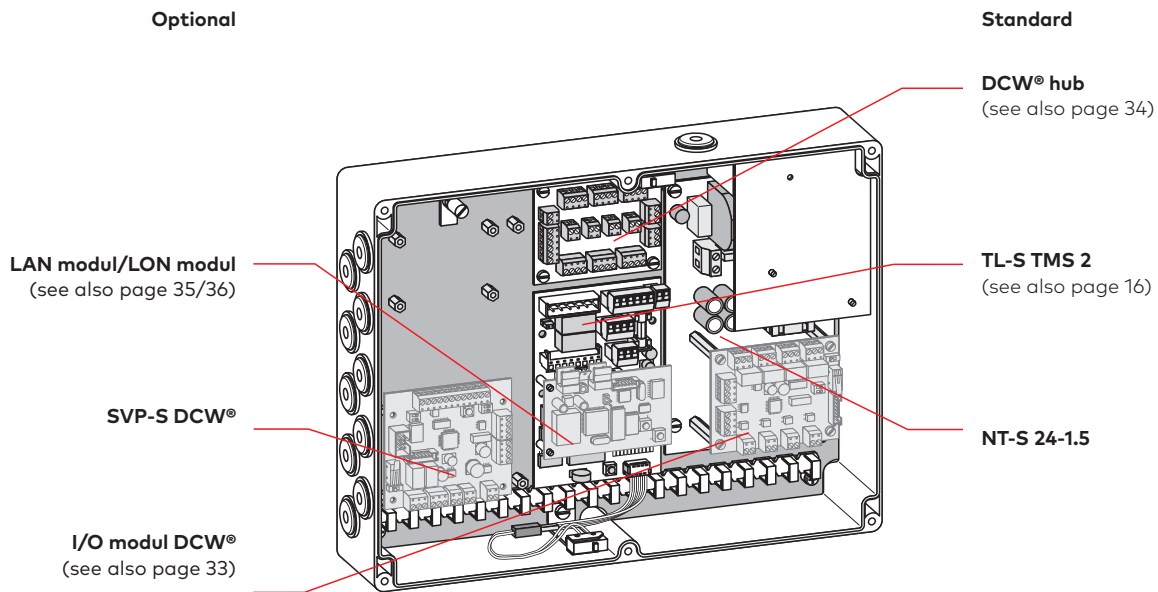

Terminal assignment and functions NT-S 24-1.5

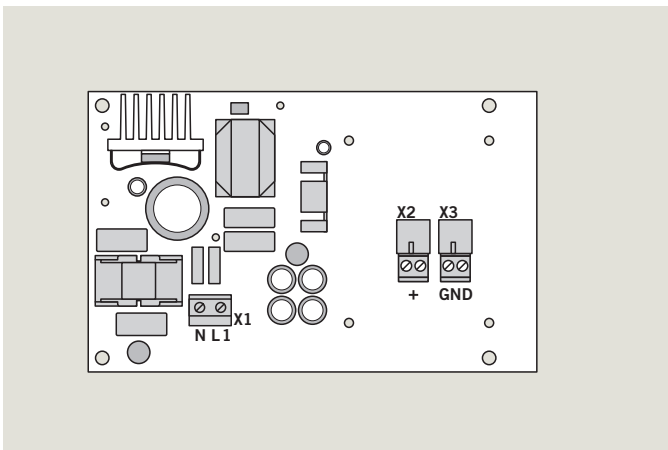

- X1**

⊖	←	230 V AC+/-15 % Power supply
⊕	←	
- X2**

⊖	→	+24 V DC
⊕	→	+24 V DC
- X3**

⊖	⊥	GND
⊕	⊥	GND

Product description**Order No.**

56331100

RZ TMS 2 emergency exit control

In IP 54 plastics enclosure with cover contacts; including NT-S 24-1.5 power supply board, TL-S TMS 2 with integral dual-port I/O module, DCW® hub, prepared for installation of motor lock control type DORMA SVP-S 22, LON module or LAN module, TV DCW® interface connector and 4-port I/O modules.

Emergency power supply via DORMA 230V AC USV 700 uninterruptible power supply (UPS) module possible.

Designed for connection of up to four TL-G 3xx/5xx DCW® or TL-NC UP S55, electronic keeps/door locking devices type TV 1xx DCW®, TV 2xx DCW®, TV 5xx DCW®, and key switches type ST 3x DCW®, and also other DCW® bus devices.

Suitable for connection of a hazard alert panel (GMA) and/or fire alarm panel (BMA) or smoke detector type RM or RS DCW® for emergency unlocking via floating contact. DCW® system bus with automatic device detection and default parameterisation of all DCW® system components; customer-specific requirements programmable via configuration software TMS-Soft from Version 4.0. Integrated access control function with TMS-Soft/CODIC Card Soft.

Suitable for connection of various DCW®-compatible access control readers. Integrated short-time, long-time and permanent unlocking via key-operated momentary contact device (e.g. TL-G 3xx/5xx DCW®, TL-NC UP S55 or ST key switch), programmable with parameterisable key operating times and functions. Power failure leads to immediate locking. Automatic re-locking after authorized unlocking event adjustable between 3 and 180 seconds via short-timer control or between 3 and 60 minutes via long-timer control freely programmable with configuration software TMS-Soft from Version 4.0. Once the timers have run down, open-time monitors are enabled. Door open alarm can be delayed for between 5 and 180 seconds. Duration of pre-alarm and main alarm programmable.

The system can also be programmed to perform immediate locking via door contact, with automatic relocking system activated. Differentiated audible alarm signals to indicate door open time exceeded (pre and/or main alarm), sabotage, tamper attempt, emergency open and fire alarm, with local alarm and automatic local alarm switch-off after 180 seconds via door terminal. Configurable alarm and signal loudness volumes. Integrated differential bus cabling (monitored for breakage/short-circuit faulting).

Adjustable and definable functions of the external key-operated momentary contact device, e.g. TL-G 3xx/ 5xx DCW®, TL-NC UP S55 or ST 32 DCW®, dormakaba DCW® I/O module. Integrated input and output modules for connection of conventionally wired products to the dormakaba DCW® system bus. Four opto-coupler inputs for transmission of external signals and control commands (floating or non-floating) and four floating outputs for actuation control of external components or for triggering of signals. Prepared for connection via LON module to dormakaba LON bus and standard LON with FTT10A protocol or connection via LAN module to LAN bus with TCP/IP.

Power supply:	230 V AC, ± 10%
Current input max.:	85 mA,
	105 mA (in alarm mode),
Dimensions (W x H x D) approx.:	300 x 230 x 85 mm

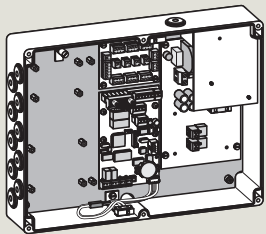

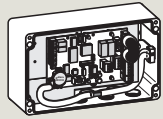
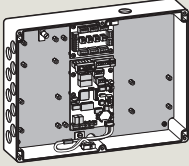
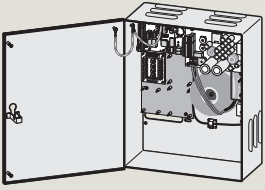
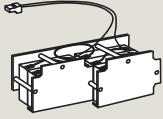
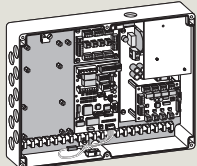
Product description	Order No.	
	<p>RZ TMS Compact Emergency exit control in IP 54 enclosure with 1A power supply unit. Function as with RZ TMS 2, but without DCW® hub and sockets for mounting further devices. Dimensions (W x H x D): approx. 200 x 230 x 90 mm</p>	56331102
	<p>RZ TMS 2 24 V Emergency exit control in enclosure without power supply unit Function as with RZ TMS 2, but for connection to 24V DC power supply units and emergency power packs or other power supply systems by others to DIN 60950.</p>	56331124
	<p>RZ TMS 2 NT Emergency exit control in enclosure with power supply unit NT 1224 N Function as with RZ TMS 2, but for connection to 230 V supply, prepared for emergency power supply by rechargeable battery pack AP 3034 (not included). Dimensions (W x H x D): approx. 305 x 380 x 130 mm</p>	56331110
	<p>AP 3034 emergency back-up power battery Emergency power supply, 30V / 3.0 Ah for NT 1224 (N), to maintain operation of emergency exit or door security system up to approx. 1 h at max. charge of 12V, 1 A and 24V , 1.5 A in the event of a power failure or voltage dip.</p>	56623400
	<p>RZ-TMS VdS Emergency exit control RZ TMS, Version VdS (approved by German property insurance association). Functions as per RZ TMS 2 but, in conjunction with TV 1xx DCW® (VdS approval number G105124) or TV 2xx DCW® (VdS approval number G105125), approved as pulse blocking element in intruder alarm systems up to Class C. Including CD-ROM with special TMS-Soft 3.0 version and special parameter database.</p>	56331128

TV 1xx DCW® – Electronic keep

Electronic keep (electrical door locking device) for top-jamb/frame mounting. Connection to the TMS door management system via DCW® system bus. The TV 1xx DCW® door locking element opens immediately and is immune to side load jamming. The max. holding force corresponds to the German DIBt code of practice entitled "Requirements for electrical locking systems on doors in emergency escape routes" (EitVTR).

F Approval certification

In Germany, installation on DIN fire and smoke control doors is only permitted provided that the suitability verification certificates relating to these doors include such applications, and provided that the requirements contained in said approval certificates are adhered to. Ensure compliance with relevant national and local regulations.

Note

A weather guard must be fitted to protect external installations.

TV 1xx

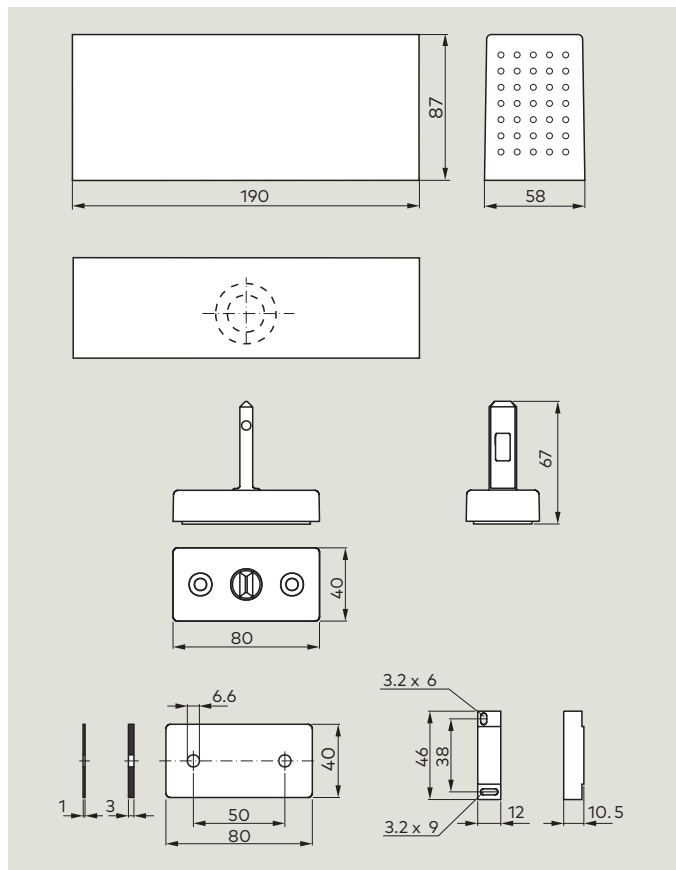

TV-Z

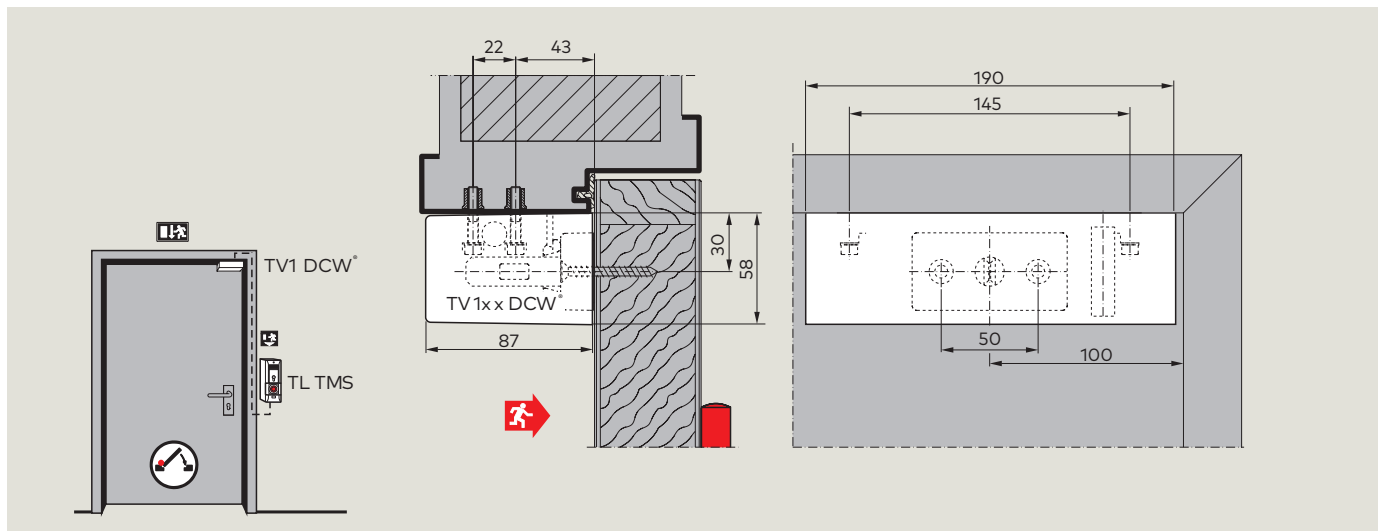
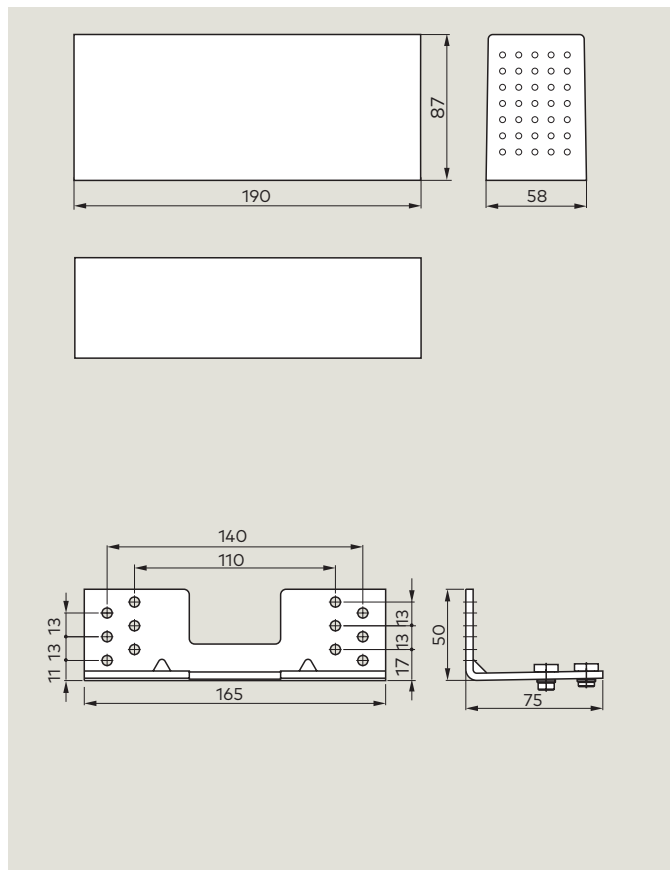

Installation in the frame reveal, **outward opening**

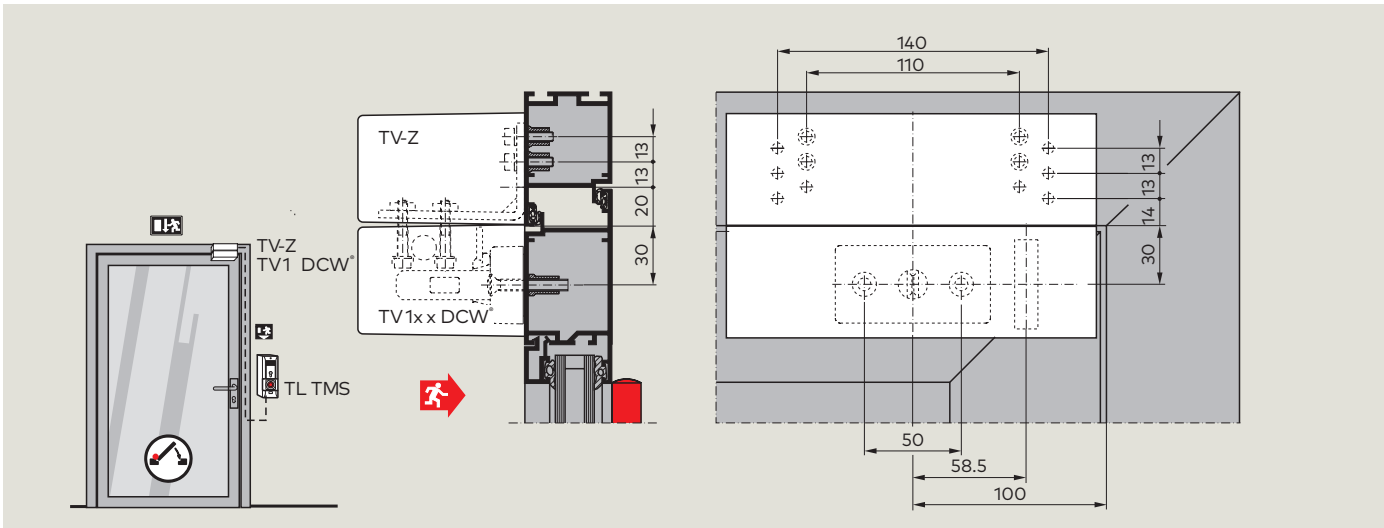

Installation on flush-closing door with TV-Z shim set on the frame, **outward opening**

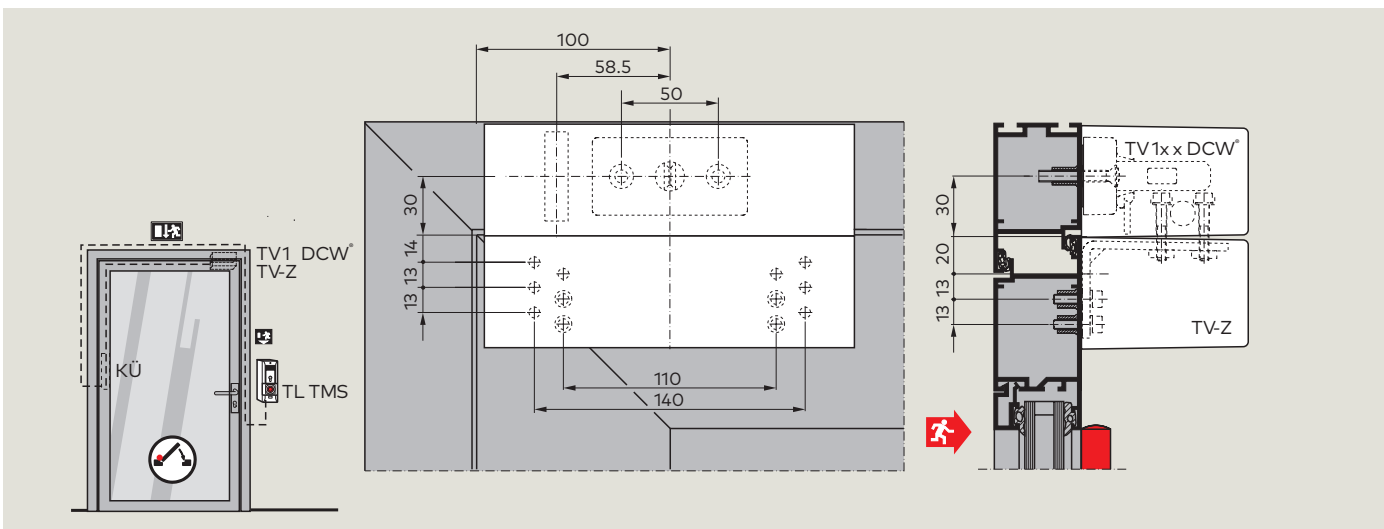

Installation on flush-closing door with TV-Z shim set on the door exterior, without limitation of the clear passage height, **outward opening**

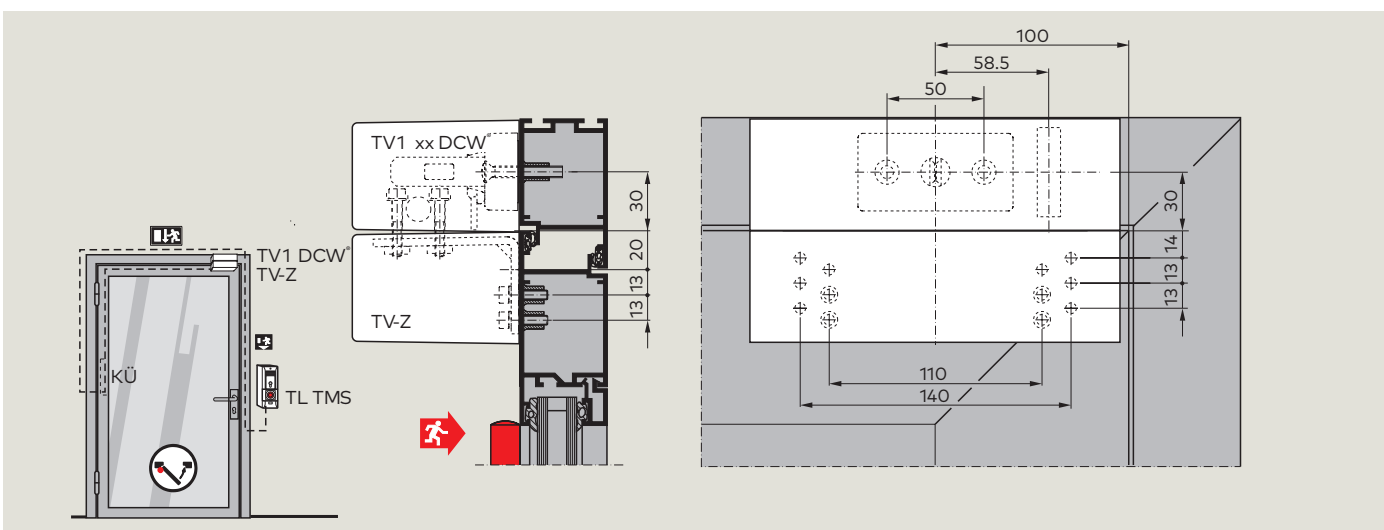

Installation on flush-closing door with TV-Z shim set on the door without limitation of the clear passage height, **inward opening**

TV 1xx DCW® – Electronic keep

Technical data

Power supply	24 V DC ±10% stabilised
Current input, max.	250 mA

Terminal assignment and functions

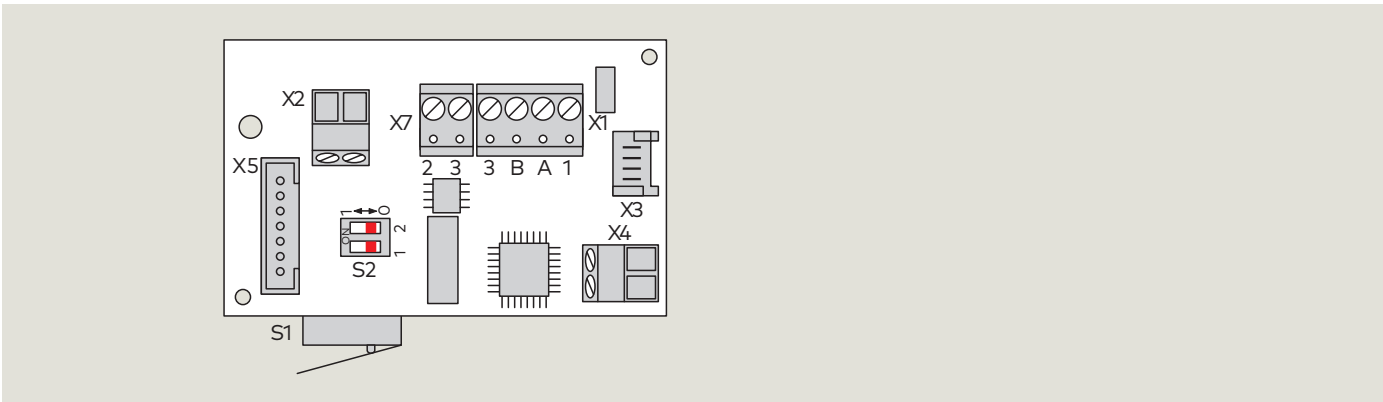

- X1** Connection to TL-S TMS 2
- X2** Connection to the internal door contact
- X3** Connection to the locking electro-magnet
- X4** Connection to the internal door contact
- X5** Connection to the firmware programming system
- X7** Switched power supply ("Emergency Stop" circuit)
- S1** Enclosure anti-sabotage/anti-tamper contact
- S2** Micro-switches (DIP) for setting the device address:

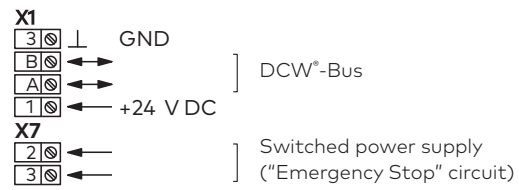

Switch	Adress	
1 2		
0	0	1
1	0	2
0	1	3
1	1	4

Product description

Order No.

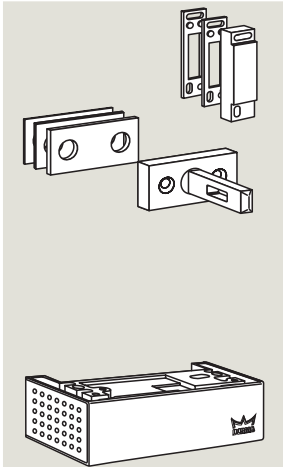
**TV 1xx DCW®**

Electronic keep (electrical door locking device), failsafe principle with anti-tamper and door monitoring contacts, plus integrated positive-action monitoring system for active/inactive status. Installed in anti-corrosion and sabotage-protected metal enclosure, spray painted.

Standard package including bracket, shim set and pack of fixings.

Connection to the dormakaba TMS door management system via DCW® system bus.

Power supply:	24 V DC, ± 10%
Current input, max.:	250 mA
Recommended cabling:	I-Y(ST) Y4 x 2 x 0.6
Dimensions (W x H x D):	approx. 190 x 58 x 87 mm
<input type="checkbox"/> TV 101 DCW®	silver
<input type="checkbox"/> TV 103 DCW®	dark brown
<input type="checkbox"/> TV 104 DCW®	stainless steel finish
<input type="checkbox"/> TV 111 DCW®	white (sim. to RAL 9016)
<input type="checkbox"/> TV 199 DCW®	special colour

56322101

56322103

56322104

56322111

56322199

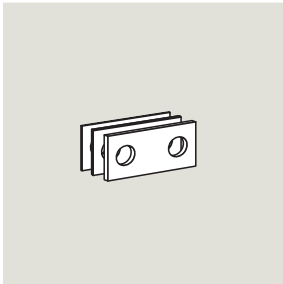
**TV-Z 01**

Shim set for adjusting the bracket of the TV 1xx DCW® electronic keep to compensate for large installation tolerances. 2 shims 1 mm thick, 1 shim 3 mm thick.

56520101

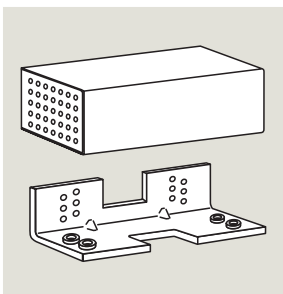
**TV-Z 1xx**

Fixing unit for installation of the TV 1xx DCW® / TV 2xx DCW® electronic keep to flush-closing doors. Zinc-plated steel angle bracket with spray-painted cover, with anti-removal protection.

Dimensions (W x H x D):	approx. 190 x 58 x 84.5 mm
<input type="checkbox"/> TV-Z 101	silver
<input type="checkbox"/> TV-Z 103	dark brown
<input type="checkbox"/> TV-Z 104	stainless steel finish
<input type="checkbox"/> TV-Z 111	white (sim. to RAL 9016)
<input type="checkbox"/> TV-Z 199	special colour

56522201

56522203

56522204

56522211

56522299

TV 2xx DCW® – Electronic keep

Electro-magnetic door locking device (electronic keep) for top jamb/frame mounting.
 Connection to TMS door management system via DCW® system bus.
 The TV 2xx DCW® door locking element is a surface-cohesion electro-magnet offering high holding forces and small dimensions.
 The max. holding force corresponds to German DIBt code of practice entitled "Requirements for electrical locking systems on doors in emergency escape routes" (EltVTR).

F Approval certification

In Germany, installation on DIN fire and smoke control doors is only permitted provided that the suitability verification certificates relating to these doors include such applications, and provided that the requirements contained in said approval certificates are adhered to. Ensure compliance with relevant national and local regulations.

Note

A weather guard must be fitted to protect external installations.

TV 2xx

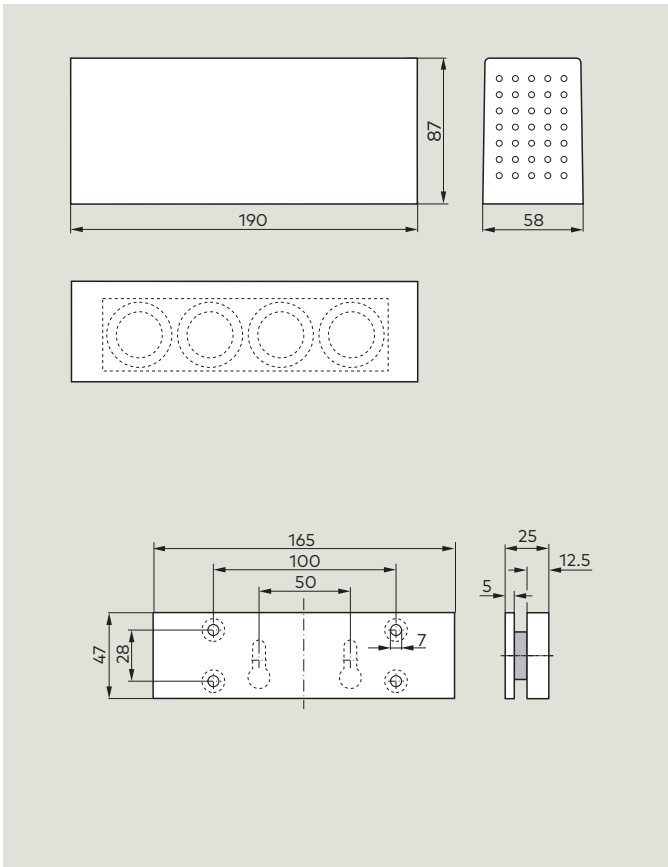

TV-Z

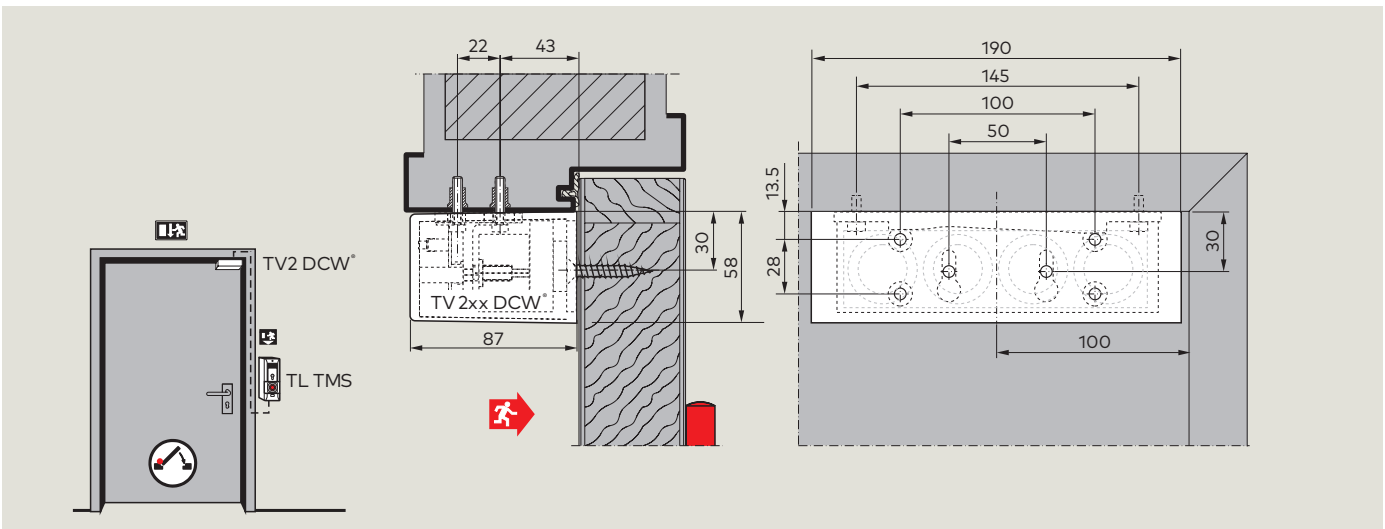
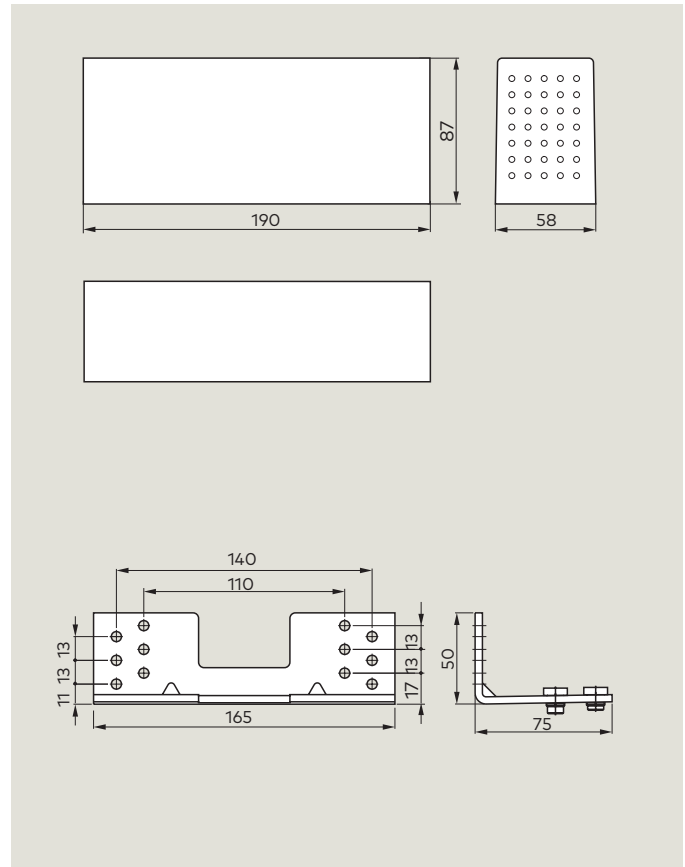

Installation in the frame reveal, **outward opening**

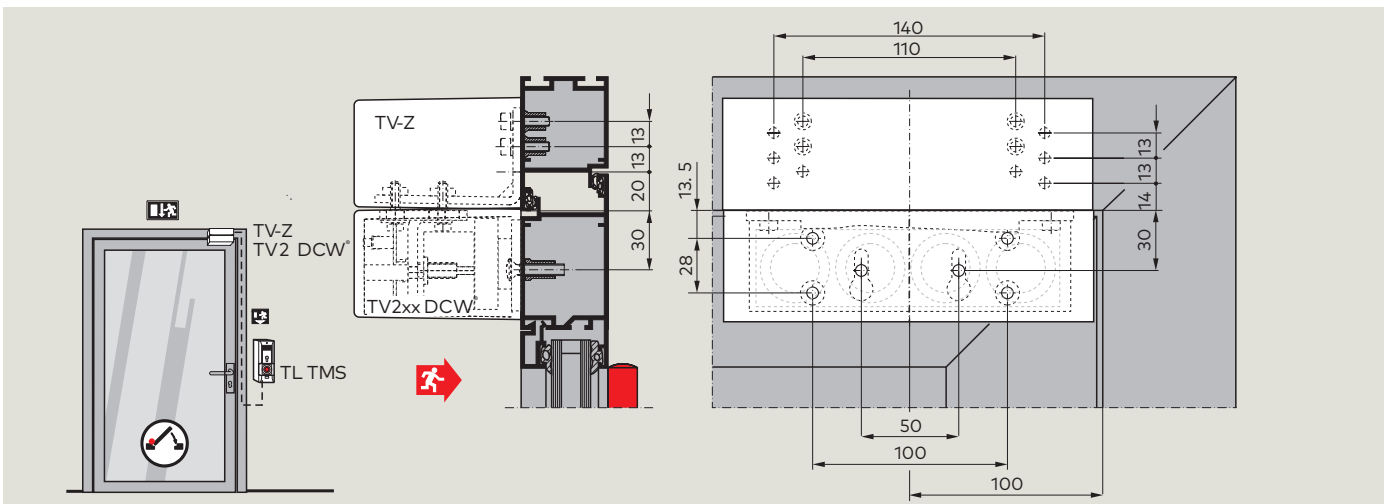

Installation on flush-closing door with TV-Z shim set on the frame, **outward opening**

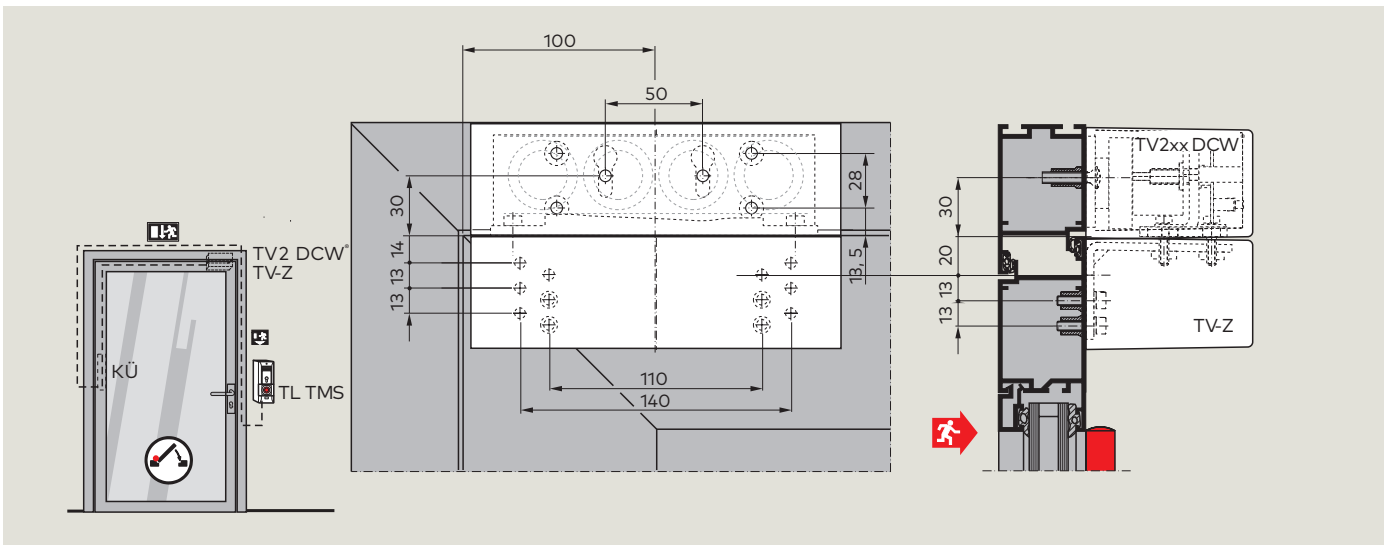

Installation on flush-closing door with TV-Z shim set on the door exterior, without limitation of the clear passage height, **outward opening**

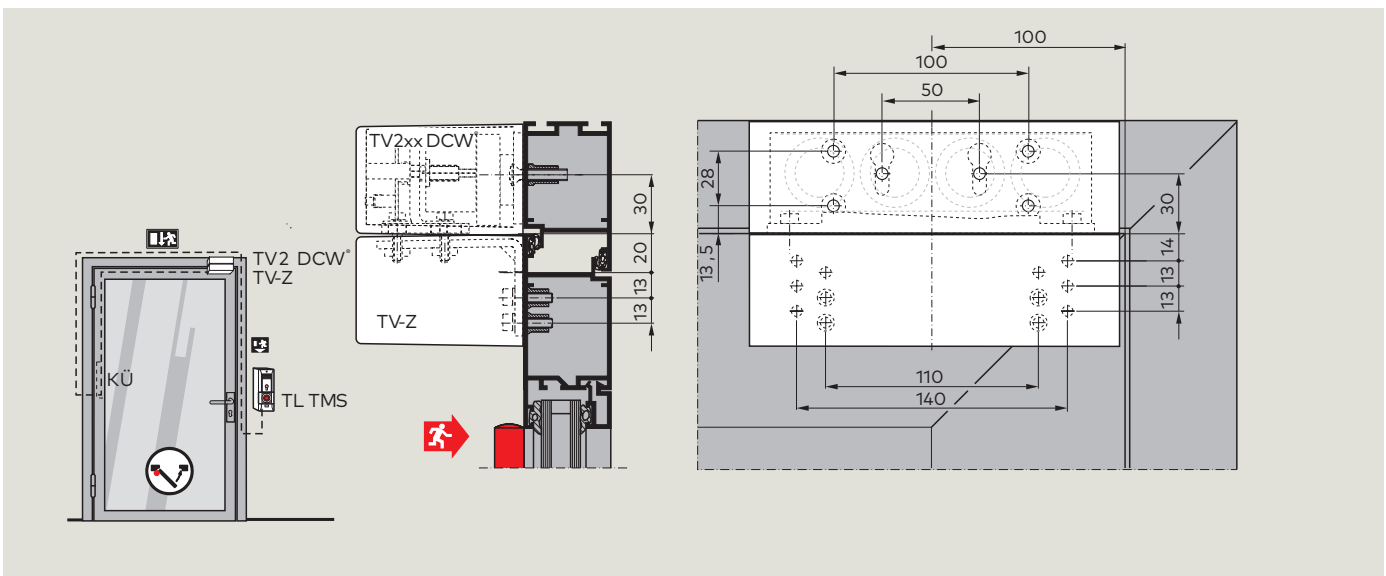

Installation on flush-closing door with TV-Z shim set on the door without limitation of the clear passage height, **inward opening**

TV 2xx DCW® – Electronic keep

Technical data

Power supply	24 V DC ±10% stabilised
Current input, max.	200 mA

Terminal assignment and functions

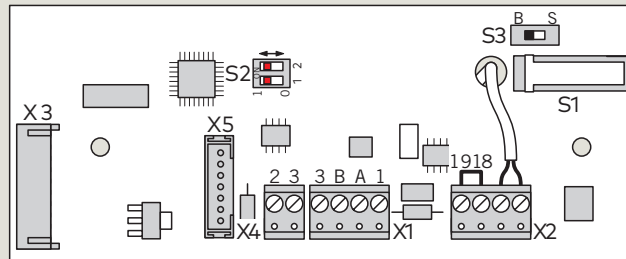

- X1** Connection to TL-S TMS 2
- X2** Connection to the internal plunger contact / external door contact
- X3** Connection to TV 2xx electronic keep
- X4** Switched power supply ("Emergency Stop" circuit)
- X5** Connection to the firmware programming system
- S1** Enclosure anti-tamper contact
- S2** Micro-switches (DIP) for setting the device address:

Switch	Adress	
1		2
0	0	1
1	0	2
0	1	3
1	1	4

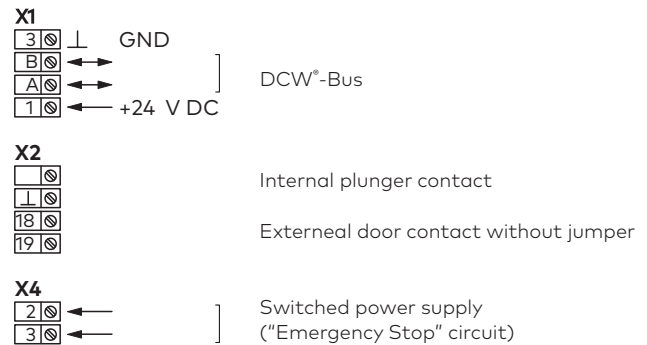

- S3** B = Normal operation (anti-tamper contact activated)
S = Service mode (anti-tamper contact de-activated)

Product description

Order No.

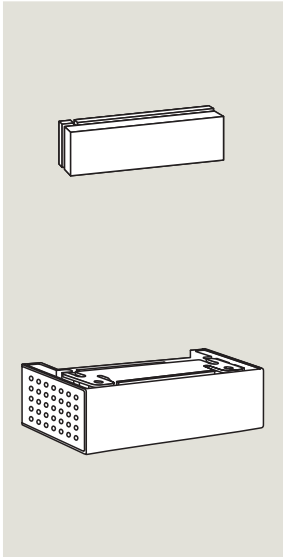
**TV 2xx DCW®**

Electro-magnetic door locking device (electronic keep, failsafe principle) with anti-tamper and door monitoring contacts, plus integrated positive-action monitoring system for active/inactive status.

Magnet mounted on universal (Cardan) joint offering three-dimensional adjustability. Housed in anti-corrosion, sabotage-protected metal enclosure, spray painted.

Standard package including strike plate (also for fire doors) and fixings. Max. holding force per EltVTR (see above) with load-independent jam-free unlocking and release.

Connection to the TMS door management system via DCW® system bus.

Power supply:	24 V DC, ± 10%
Current input, max.:	200 mA
Recommended cabling:	I-Y(ST) Y4 x 2 x 0.6
Dimensions (W x H x D):	approx. 190 x 58 x 87 mm.
<input type="checkbox"/> TV 201 DCW®	silver
<input type="checkbox"/> TV 203 DCW®	dark brown
<input type="checkbox"/> TV 204 DCW®	stainless steel finish
<input type="checkbox"/> TV 211 DCW®	white (sim. to RAL 9016)
<input type="checkbox"/> TV 299 DCW®	special colour

56322201
56322203
56322204
56322211
56322299

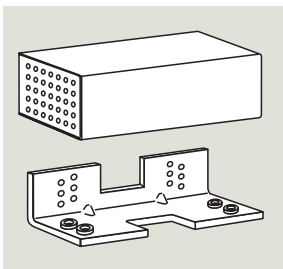
**TV-Z 1xx**

Fixing unit for installation of the TV 1xx DCW® / TV 2xx DCW®

Zinc-plated steel angle bracket with spray-painted cover, with anti-removal protection.

Dimensions (W x H x D):	approx. 190 x 58 x 84,5 mm
<input type="checkbox"/> TV-Z 101	silver
<input type="checkbox"/> TV-Z 103	dark brown
<input type="checkbox"/> TV-Z 104	stainless steel finish
<input type="checkbox"/> TV-Z 111	white (sim. to RAL 9016)
<input type="checkbox"/> TV-Z 199	special colour

56522201
56522203
56522204
56522211
56522299

TV 5xx DCW® – Electronic keep

Electrical door locking device for concealed top jamb/frame mounting. Connection to the TMS door management system via DCW® system bus. Also suitable as an electric strike for emergency exit doors. Integrated feedback contacts for monitoring the active/inactive conditions. Suitable for doors with both over-rebated and flush meeting stiles. Max. holding force as per German DIBt code of practice entitled "Requirements for electrical locking systems on doors in emergency escape routes" (EltVTR).

F Approval certification

In Germany, installation on DIN fire and smoke control doors is only permitted provided that the suitability verification certificates relating to these doors include such applications, and provided that the requirements contained in said approval certificates are adhered to.

Ensure compliance with relevant national and local regulations.

TV 501 DCW® / TV 502 DCW®

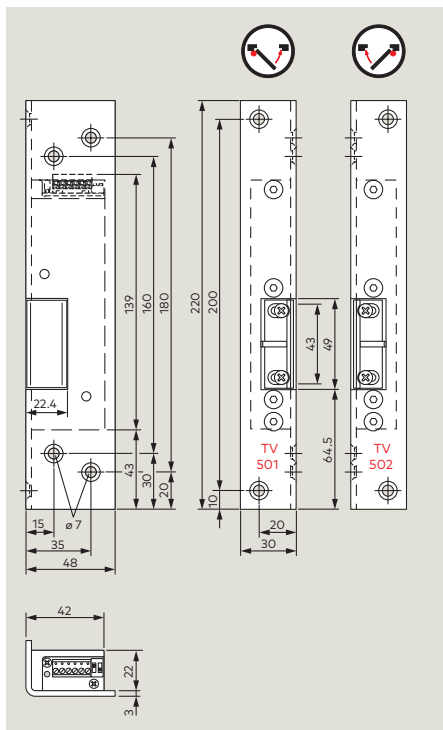

TV 505 DCW® / TV 506 DCW®

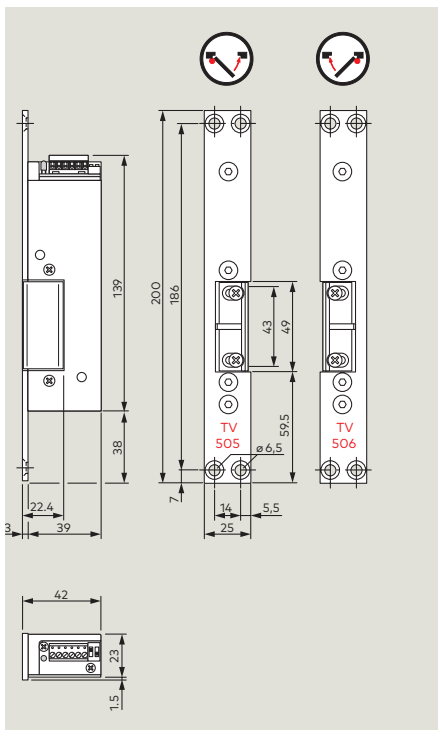

TV 507 DCW® / TV 508 DCW®

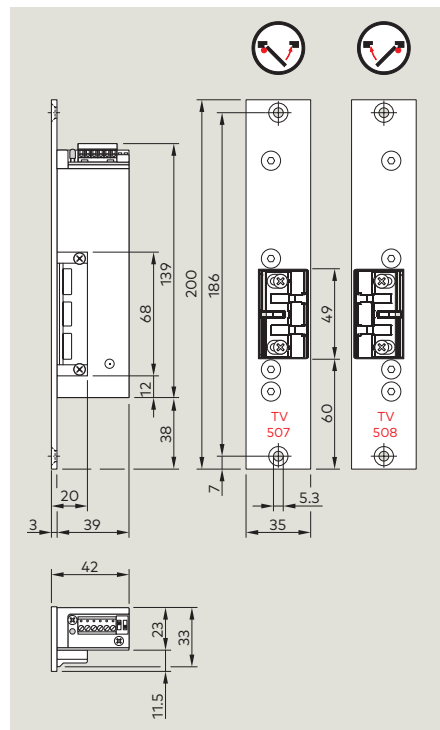

Terminal assignment and functions

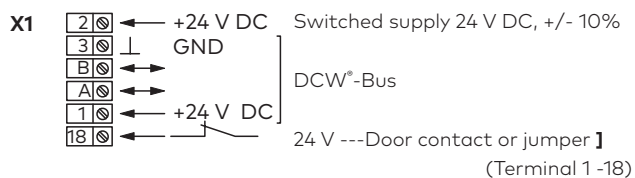
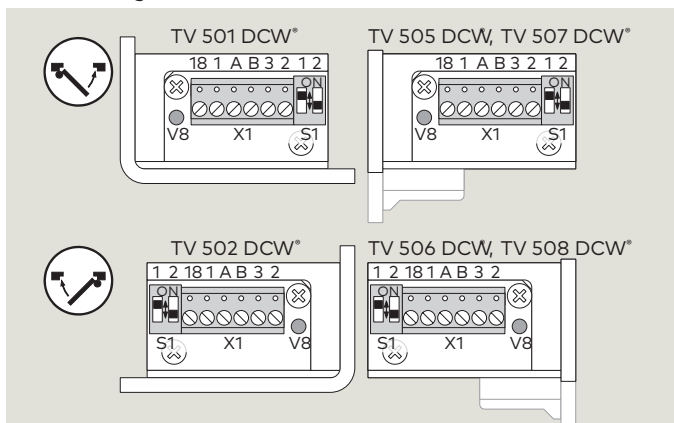

V8 **LED DCW®-Bus**
LED on bus connection OK
LED off no power supply or bus connection

S1 Micro-switch for setting the device address:

Switch S1	Adress
1	2
0 0	1
1 0	2
0 1	3
1 1	4

Technical data TV 50x DCW®

Power supply	24 V DC ±10% stabilised
Current input	
– Quiescent current	20 mA
– TV 50x DCW® locked	74 mA

Product description

Order No.

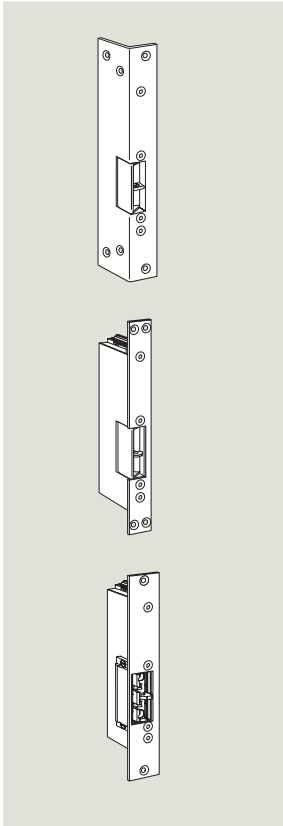
**TV 5xx**

Electronic exit keep/electric strike for escape route doors with integrated DCW® interface for direct connection to a TMS emergency exit control system; integrated feedback contacts to monitor if the TV locking device is "active" or "inactive" and if the door is "open/closed" All versions with adjustable latch.

Supply set includes flanged strike plate and screw pouch.

Jam-free unlocking irrespective of loads, max. keep-closed force according to EltVTR (German guideline on electrical locking systems for doors used in emergency exits and escape routes).

Power supply: 24 V DC +/- 5 %
 Current input max.: 58 mA
 Recommended cabling: I-Y(ST) Y4 x 2 x 0.6
 Dimensions (W x H x D)

TV 501,502,505,506 without strike plate: ca. 23,5 x 134 x 39 mm

TV 507, 508 without strike plate: ca. 33,0 x 134 x 39 mm

**With rebated strike plate 30 x 48 x 220 x 3 mm
 for over-rebated doors**

- TV 501** ISO 6 (LH)
 TV 502 ISO 5 (RH)

15151124
 15151224

**With standard flanged strike plate 25 x 200 x 3 mm
 for doors with flush meeting stiles**

- TV 505** ISO 6 (LH)
 TV 506 ISO 5 (RH)

15151524
 15151624

**With standard flanged strike plate 35 x 200 x 3 mm
 with latch guide for doors with flush meeting stiles**

- TV 507** ISO 6 (LH)
 TV 508 ISO 5 (RH)

15151724
 15151824

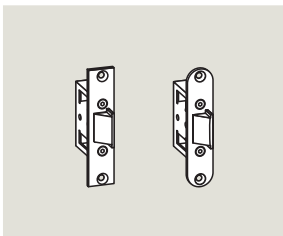
**TV-Z 510**

Mortise latch lock as counterpart to the TV 50x for installation in the door leaf

- Forend 24 x 110 x 3**
 Forend 24 x 110 x 3, radiused ends
 Forend 28 x 110 x 3
 Forend 20 x 110 x 3

15198124
 15198224
 15198128
 15198120

DCW® I/O Modul – Bus interface module

The DCW® I/O module offers four inputs and four outputs for connection and activation control of external components. Up to four I/O modules can be operated within the TMS system.

In order to simplify programming, the inputs and outputs are already pre-programmed but can be individually configured as required.

Terminal assignment and functions I/O-Modul DCW®

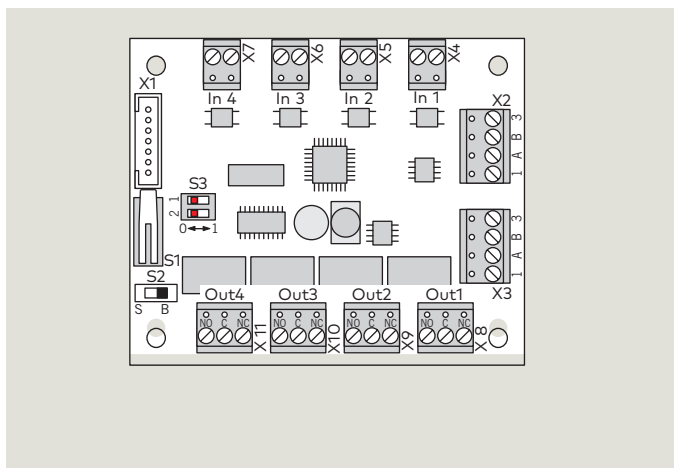

DCW® I/O modul circuitry

Technical data

Power supply	24 V DC, ± 10% stabilised
Current input, max.	45 mA
Switching capacity	24 V / 1 A (30 W / 62,5 VA max.)

- X1** Connection to firmware programming system
- S1** Enclosure anti-tamper contact
- S2** B = Normal operation (anti-tamper contact activated)
S = Service mode (anti-tamper contact de-activated)
- S3** Micro-switches (DIP) for setting the device address:

Switch	Address		
1		2	
0	0	1	
1	0	2	
0	1	3	
1	1	4	

	Address 1	Address 2	Address 3	Address 4
	Panel function	General function	Airlock control function	SVP / automatic function
DCW ext. X2				
DCW ext. X3				
In 1		Short-time unlocking*	Hazard alarm control panel*	Access control 1, door 1*
In 2		Long-time unlocking*	Anti-tamper contact*	Disabling input*
In 3		Permanent unlocking*	Door contact*	Opposite side (door 2) is unlocked*
In 4		Locking function*	Freely parameterisable	Short-time unlocking*
Out1		Pre-alarm (door open)*	Permanent unlocking active*	Freely parameterisable
Out2		Main alarm (door open)*	Power fail*	Freely parameterisable
Out3		Emergency pushbutton operated*	Freely parameterisable	TV locked/unlocked*
Out4		Locked*	Freely parameterisable	Freely parameterisable

* or freely parameterisable

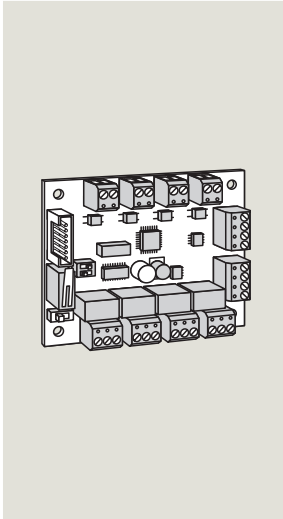
Product description**Order No.****DCW® I/O modul**

Bus interface module for connection of devices with conventional cabling systems to the DCW® system bus.

Four opto-coupler inputs for transmission of external signals and control commands e.g. disabling input for intruder alarm (floating or non-floating) and four floating outputs for the actuation control of external components or signal outputs. Up to four DCW® I/O modules possible per TMS door management system.

Addresses for various requirements pre-parameterised.

Individual requirements can be freely configured with parameter configuring software TMS-Soft (switch-on delay, switch-off delay, pulse mode, logic gating, etc.).

Can be installed in DCW® hub junction box, RZ TMS , TL-G 3xx/5xx (without LON module), etc.

Power supply:	via DCW® bus
Current input, max.:	45 mA
Opto-coupler inputs:	U_{in}/I_{in} , 5 V/2.8 mA, 12 V/8 mA, 24 V/17 mA, 30 V/28 mA
Relay outputs:	24 V DC/1 A

56350100

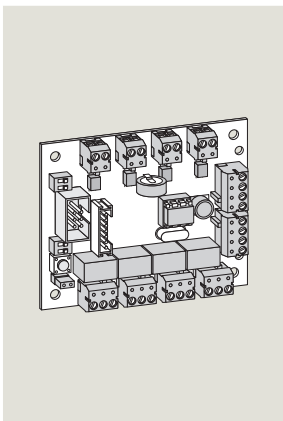
**DCW® I/O modul/LON/LAN**

Bus interface module for connection of devices with analogue switching contacts to the DCW® system bus or suitable for networking via LON modules and LON gateway or LAN modules. Four opto-coupler inputs (interface connection with signals of 5-30V AC/DC) for external actuation control. Four floating outputs for control of external components or other output signals.

In the LON/LAN mode, the inputs and outputs can be freely parameterised and adopted in the visualisation system through TMS-Soft implementation (V5.x or later).

Power supply:	via DCW® bus or LON/LAN bus
Current input, max.:	45 mA.
Opto-coupler inputs:	U_{in} , 5 V/2.8 mA, 12 V/8 mA, 24 V/17 mA, 30 V/28 mA
Relay outputs:	24 VDC/1 A

56333451

TMS – Accessories

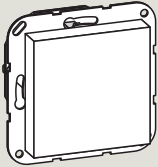
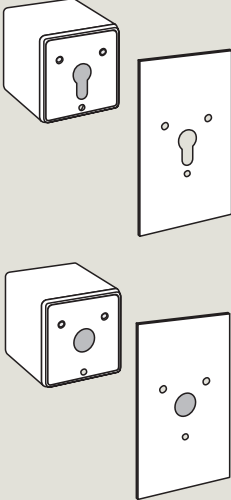
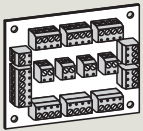
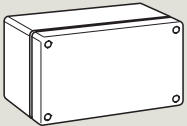
Product description	Order No.	
	<p>I/O module IOM-G00 DCW®</p> <p>Bus interface connector module for the connection of devices with conventional wiring to the DCW® system bus. Two opto-coupler inputs for the transmission of external signals or control commands and two outputs for the control of external components.</p> <p>The module can be installed in standard device boxes 65 mm Ø as well as surface-applied. The I/O modules can be combined with the switch ranges FR-x, Berker, GIRA, Jung or Merten.</p> <p>The supply voltage of the I/O modules may optionally be drawn via the DCW® bus from the TMS control unit.</p> <p>Opto-coupler inputs: 24V DC.</p> <p>Relay outputs: change-over contact 45V DC / 35V AC / max. 2 A.</p> <p>Dimensions of the cover (W x H): 55 x 55 mm.</p> <p>Installation in standard device box (62 mm deep) to DIN.</p> <p>Covers in white (sim. to RAL 9010), silver and anthracite included in scope of supply.</p>	19357100
	<p>ST 3x DCW®</p> <p>Key switch of anti-tamper design with LED display (red/green), light aluminium alloy enclosure, silver finish, with front panel, suitable for surface and flush mounting, for activation control of the TMS door management system.</p> <p>Functionality of the ST 3x DCW® key switch adjustable and definable via TMS-Soft parameterisation software. Connection to TMS door management system via DCW® system bus.</p> <p>Dimensions (W x H x D), enclosure: approx. 75 x 75 x 50 mm Front panel (flush mounted): 90 x 100 x 2 mm</p> <ul style="list-style-type: none"> <input type="checkbox"/> ST 32 DCW® prepared for europrofile single cylinder by others to DIN 18252 (locking cam centre 30-32.5 mm, overall length 40.5-43.5 mm), cam position left (90°) <input type="checkbox"/> ST 34 DCW® prepared for 22 mm Ø round single cylinder by others (locking cam centre 30-32.5 mm, overall length 40.5-43.5 mm), cam position left (90°) 	56343200
	<p>DCW® bus hub</p> <p>DCW® bus hub as PCB-type branching module for DCW® bus devices, with six-terminal blocks for the DCW® bus, terminals for branching the TV failsafe circuit and four interface blocks for external door exit terminals.</p> <p>For installation in DCW® hub junction box or enclosure by others.</p>	56352100
	<p>DCW® hub junction box</p> <p>DCW® hub junction box, IP 54, for installation of up to 4 DCW® bus hubs (branching modules) and/or DCW® I/O modules and/or TV DCW® interface connectors.</p> <p>Box dimensions (W x H x D) approx. 200 x 120 x 75 mm</p>	56352000

Product description

Order No.

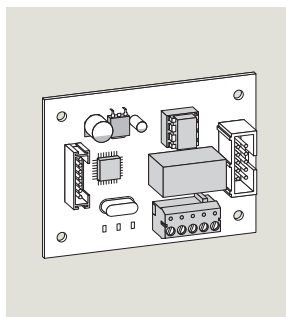
**ZM 208 DCW®**

(subject to building regs approval in some countries)
 Emergency open-time delay module for installation in TL-G or RZ TMS enclosure. 2-stage time delay per prEN 13637. 1st stage max. 15 seconds, 2nd stage max. 180 seconds. Activation of the first timer is always initiated by the emergency pushbutton of the TMS door management system. The second timer can be activated by an additionally connected pushbutton on the ZM 208 DCW® or to the TMS I/O module, and also via the TMS Software in the LON/LAN network. The TSD-DCW® touchscreen can be configured as a down-counter display.

56920801

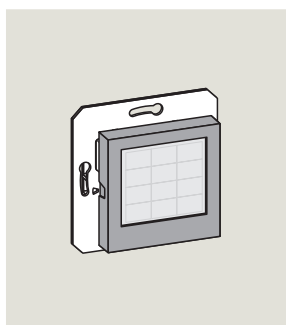
**TSD touchscreen display TSD S55 DCW®**

Touchscreen display in System 55 design for actuation control of the TMS-internal access control via code input with changing character sequence for protection against access code identification. Down-counter for time-delayed release in conjunction with ZM 208 DCW® per prEN 13637, menu for controlling the TMS functions with parameters configurable via TMS-Soft; display of status messages.

- silver
- white
- anthracite

56340201
 56340210
 56340215

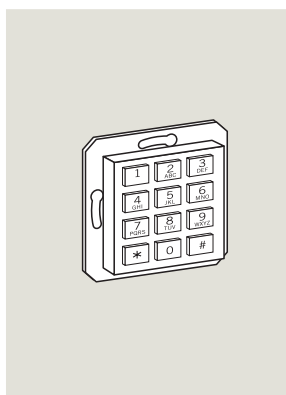
**CODIC CARD System 55 keypad reader unit CRH-Kxx DCW®**

Keypad type reader unit, System 55 design, for activating the TMS-internal access control function by inputting a PIN or access code and/or for the contactless reading of the serial numbers of ID cards or transponder fobs. Reading distance approx. 5 cm. Unit cover anti-tamper monitored; illuminated keys; can be combined with the non-metallic frame-type switch trim ranges FR-x, Berker, GIRA, Jung or Merten. Power supply via DCW® bus. Installation in standard device box (62 mm deep) to DIN Read formats 125 kHz, HITAG 1, HITAG 2, EM 4102 and EM 4150 without password protection

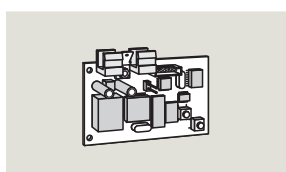

- CRH-K01 DCW®** Keypad reader silver
- CRH-K10 DCW®** Keypad reader white
- CRH-K15 DCW®** Keypad reader anthracite

19250501
 19250510
 19250515

**TMS LON modul**

Module including earth/ground cable for plug-in connection of the TMS door management system to dormakaba LON bus systems. The module is plugged onto the TL-S TMS 2 board.

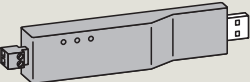
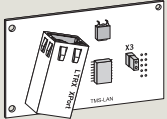
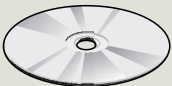
56335300

Product description	Order No.	
	<p>TMS LON UP Modul For installation in standard device boxes (62 mm deep) to DIN</p>	56353002
	<p>TMS LON-gateway USB Gateway for networking dormakaba door management systems with TMS LON modules and for connection via USB port to PC systems with TMS-Soft. Number of doors in network equivalent to up to 1000 devices. Dimensions (W x H x D): 23 x 18 x 114 mm</p> <p>Scope of supply: 1 USB gateway 1 Driver software</p>	56333403
	<p>TMS LAN-TCP/IP Modul Module for plug-in connection to TL-S TMS 2, RZ TMS 2 or SVP-S 22 DCW®. The TMS LAN-TCP/IP module enables both TMS control centres and also the PC management system from TMS-Soft 5.0 to be interconnected via an Ethernet bus.</p> <p>The PC needs a standard commercial Ethernet card.</p>	56353001
 	<p>TMS Soft V 4.x software TMS Soft V4.x control, parametrisation and visualisation software for control and configuration of all adjustable functions and parameters of a TMS door management system via PC; control, parametrisation and visualisation of individual TMS door management systems via RS 232 interface, ready for connection of an unlimited number of doors in networked TMS door management systems via LAN or LON bus system. Furthermore, the software allows parametrisation of individual SVP-S 2x DCW® and M-SVP-S 24 DCW® control units. The access control feature integrated within the TMS system can be activated using MATRIX and any DCW® access control reader. A demo version of the DoorManager is provided with every TMS software.</p> <p>System requirements: PC with Pentium processor, min. 512 MB RAM, min. 25 MB free hard disk capacity, VGA graphics card, resolution min. 800 x 600 pixel, CD-ROM drive, mouse, serial interface or USB port, Windows NT, 2000, XP or Windows 7.</p> <p>Scope of supply: 1 CD-ROM 1 TMS-PC adapter for extension cable to update from TMS-Soft V2.x, V3.x and V4.x</p>	56339104

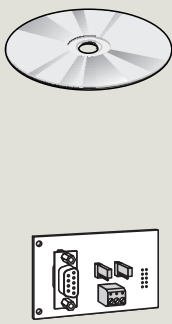
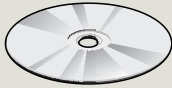
	Product description	Order No.
	<p>Parametrierungssoftware TMS Soft Basis</p> <p>TMS Soft basic control, parametrisation and visualisation software for control and configuration of all adjustable functions and parameters of a TMS door management system via PC. Control, parametrisation and visualisation of individual TMS door management systems via RS 232 interface. Furthermore, the software allows parametrisation of individual SVP-S 2x DCW® and M-SVP-S 24 DCW® control units. A demo version of the DoorManager is provided with every TMS software.</p> <p>System requirements: PC with Pentium processor, min. 512 MB RAM, min. 25 MB free hard disk capacity, VGA graphics card, resolution min. 800 x 600 pixel, CD-ROM drive, mouse, serial interface or USB port, Windows NT, 2000, or XP.</p> <p>Scope of supply: 1 CD-ROM 1 TMS-PC adapter for extension cable</p>	56339100
	<p>TMS OPC server</p> <p>for linking TMS-Soft to building or security management systems that support OPC.</p> <p>The TMS OPC server supports the following OPC (OLE for Process Control) specifications:</p> <ul style="list-style-type: none"> • Data Access V1.0A • Data Access V2.05 • Data Access V3.0 • Alarms and Events Specification 1.10. • Conditional alarms starting from 1/2009 <p>The OPC server</p> <ul style="list-style-type: none"> • is implemented as an OutProc-COM service • supports Windows NT 4.0 (from SP6a onwards), Windows 2000 and Windows XP operating systems. <p>In TMS Soft, all doors are available as data points with all the status bits. When configured via XML file, you may define individual bits as data points. Alarm and Event (AE) can also be generated for complete data points or individual bits of a data point. AE supports the "Simple Event" feature and provides data point values. It furthermore supports "AE Conditional" with "acknowledgement" (alarms and events that require acknowledgement).</p> <p>Scope of supply: 1 CD-ROM</p>	56339150
	<p>ESPA 4.4.4.</p> <p>Software interface between TMS-Soft from V4.x and telecommunication systems</p>	56339130

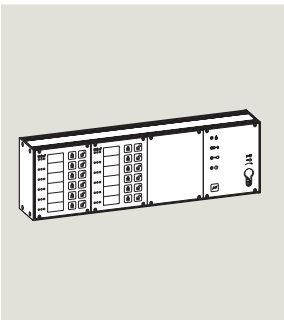
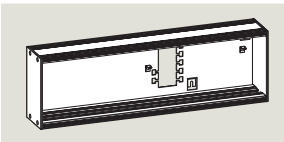
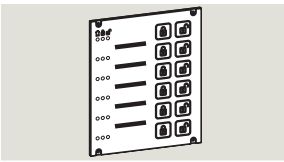
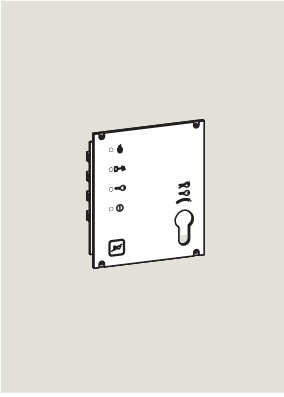
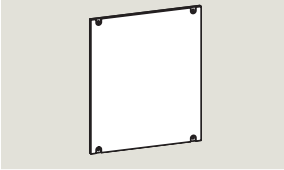
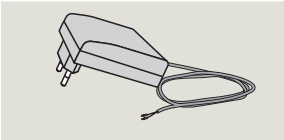
	Product description	Order No.
	<p>LON / LAN bus Steuerungstableau For monitoring and controlling emergency exit and escape route doors. Assembled on the basis of a modular kit system (e.g. TE 12 + 2x TE 60 + 1x TE 25 + 1x TE01). Emergency unlocking possible via integrated floating NC contact of a fire alarm system. Release possible by integrated emergency pushbutton TL-NC S55 and with separate closed-loop/failsafe wiring of the emergency pushbutton with the TL-S TMS 2. Parallel panel configuration and construction of a PC-networked system possible. Recommended cabling: J-Y (st) Y 2 x 2 x 0.8mm cable approx. 1000m as bus circuit.</p>	
	<p>TG 12 BUS (84 HP wide) Subrack in combined wall/desktop chassis of aluminium for single-row mounting of four modules. External dimensions (H x W x D): approx. 145 x 440 x 76 mm Finish: EV1</p>	56051210
	<p>TE 60 Control LON / LAN bus (21 HP wide) Bus operating module with operating and display elements for 6 doors. A TMS LON / LAN module is required for each operating module.</p>	56366001
	<p>TE 25 Basis LON / LAN bus (21 HP wide) Basic LON bus control, central operating and display unit for TMS; processor-controlled central module with: – buzzer as audible collective fault alarm; – pushbutton for alarm reset; – LED for operating display; – 4 LEDs for status display; – 3 inputs for fire alarm (NC contact), emergency unlocking (NC contact) and external panel disabling contact; – key switch for enabling/disabling the operational pushbuttons for controlling the doors; – group functionality. Each TE 25 basic LON / LAN BUS requires a TMS LON / LAN module. The basic unit is not absolutely necessary for operation of the LON/LAN BUS panel, but it is required for the central functions such as operating system ON/OFF, buzzer, etc.</p> <p><input type="checkbox"/> Prepared for PZ europrofile cylinder <input type="checkbox"/> Prepared for RZ round cylinder</p>	56362501 56362502
	<p>TE 01 bus (21 HP wide) Dummy insert for bus control panel.</p>	56060101
	<p>Plug-in power supply unit 24V/420 mA</p>	56366005

Width in HP = horizontal pitch slot widths of 0.8 inch each

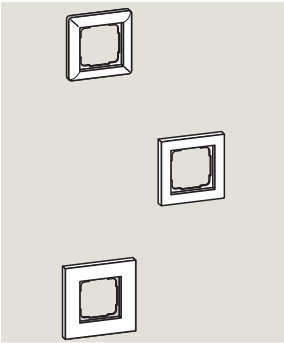
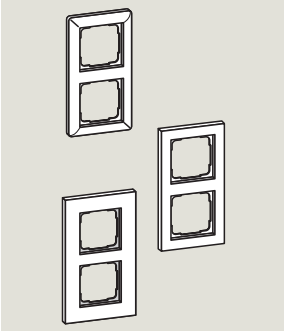
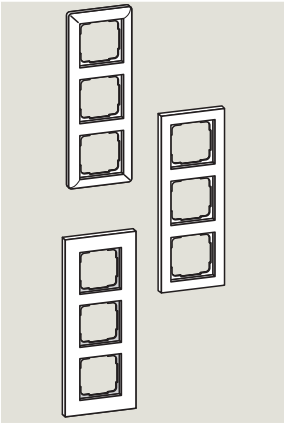
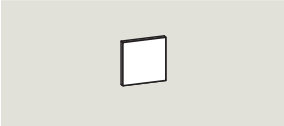
Product description	Order No.																																								
Cover frame System 55																																									
	<table border="0"> <tr> <td>FR-S55 1</td> <td>Single-unit trim</td> <td>Standard 55</td> <td>white</td> <td>56391110</td> </tr> <tr> <td>FR-E2W 1</td> <td>Single-unit trim</td> <td>E2 55</td> <td>white</td> <td>56392110</td> </tr> <tr> <td>FR-E2S 1</td> <td>Single-unit trim</td> <td>E2 55</td> <td>silver</td> <td>56392111</td> </tr> <tr> <td>FR-E2A 1</td> <td>Single-unit trim</td> <td>E2 55</td> <td>anthracite</td> <td>56392115</td> </tr> <tr> <td>FR-Esprit A 1</td> <td>Single-unit trim</td> <td>Esprit 55</td> <td>alu</td> <td>56393101</td> </tr> <tr> <td>FR-Esprit B 1</td> <td>Single-unit trim</td> <td>Esprit 55</td> <td>brass</td> <td>56393105</td> </tr> <tr> <td>FR-Esprit C 1</td> <td>Single-unit trim</td> <td>Esprit 55</td> <td>chromium</td> <td>56393115</td> </tr> <tr> <td>FR-Esprit G 1</td> <td>Single-unit trim</td> <td>Esprit 55</td> <td>glass</td> <td>56393100</td> </tr> </table>	FR-S55 1	Single-unit trim	Standard 55	white	56391110	FR-E2W 1	Single-unit trim	E2 55	white	56392110	FR-E2S 1	Single-unit trim	E2 55	silver	56392111	FR-E2A 1	Single-unit trim	E2 55	anthracite	56392115	FR-Esprit A 1	Single-unit trim	Esprit 55	alu	56393101	FR-Esprit B 1	Single-unit trim	Esprit 55	brass	56393105	FR-Esprit C 1	Single-unit trim	Esprit 55	chromium	56393115	FR-Esprit G 1	Single-unit trim	Esprit 55	glass	56393100
	FR-S55 1	Single-unit trim	Standard 55	white	56391110																																				
	FR-E2W 1	Single-unit trim	E2 55	white	56392110																																				
	FR-E2S 1	Single-unit trim	E2 55	silver	56392111																																				
	FR-E2A 1	Single-unit trim	E2 55	anthracite	56392115																																				
	FR-Esprit A 1	Single-unit trim	Esprit 55	alu	56393101																																				
	FR-Esprit B 1	Single-unit trim	Esprit 55	brass	56393105																																				
FR-Esprit C 1	Single-unit trim	Esprit 55	chromium	56393115																																					
FR-Esprit G 1	Single-unit trim	Esprit 55	glass	56393100																																					
	<table border="0"> <tr> <td>FR-S55 2</td> <td>Double-unit trim</td> <td>Standard 55</td> <td>white</td> <td>56391210</td> </tr> <tr> <td>FR-E2W 2</td> <td>Double-unit trim</td> <td>E2 55</td> <td>white</td> <td>56392210</td> </tr> <tr> <td>FR-E2S 2</td> <td>Double-unit trim</td> <td>E2 55</td> <td>silver</td> <td>56392201</td> </tr> <tr> <td>FR-E2A 2</td> <td>Double-unit trim</td> <td>E2 55</td> <td>anthracite</td> <td>56392215</td> </tr> <tr> <td>FR-Esprit A 2</td> <td>Double-unit trim</td> <td>Esprit 55</td> <td>alu</td> <td>56393201</td> </tr> <tr> <td>FR-Esprit B 2</td> <td>Double-unit trim</td> <td>Esprit 55</td> <td>brass</td> <td>56393205</td> </tr> <tr> <td>FR-Esprit C 2</td> <td>Double-unit trim</td> <td>Esprit 55</td> <td>chromium</td> <td>56393215</td> </tr> <tr> <td>FR-Esprit G 2</td> <td>Double-unit trim</td> <td>Esprit 55</td> <td>glass</td> <td>56393200</td> </tr> </table>	FR-S55 2	Double-unit trim	Standard 55	white	56391210	FR-E2W 2	Double-unit trim	E2 55	white	56392210	FR-E2S 2	Double-unit trim	E2 55	silver	56392201	FR-E2A 2	Double-unit trim	E2 55	anthracite	56392215	FR-Esprit A 2	Double-unit trim	Esprit 55	alu	56393201	FR-Esprit B 2	Double-unit trim	Esprit 55	brass	56393205	FR-Esprit C 2	Double-unit trim	Esprit 55	chromium	56393215	FR-Esprit G 2	Double-unit trim	Esprit 55	glass	56393200
	FR-S55 2	Double-unit trim	Standard 55	white	56391210																																				
	FR-E2W 2	Double-unit trim	E2 55	white	56392210																																				
	FR-E2S 2	Double-unit trim	E2 55	silver	56392201																																				
	FR-E2A 2	Double-unit trim	E2 55	anthracite	56392215																																				
	FR-Esprit A 2	Double-unit trim	Esprit 55	alu	56393201																																				
	FR-Esprit B 2	Double-unit trim	Esprit 55	brass	56393205																																				
FR-Esprit C 2	Double-unit trim	Esprit 55	chromium	56393215																																					
FR-Esprit G 2	Double-unit trim	Esprit 55	glass	56393200																																					
	<table border="0"> <tr> <td>FR-S55 3</td> <td>Triple-unit trim</td> <td>Standard 55</td> <td>white</td> <td>56391310</td> </tr> <tr> <td>FR-E2W 3</td> <td>Triple-unit trim</td> <td>E2 55</td> <td>white</td> <td>56392310</td> </tr> <tr> <td>FR-E2S 3</td> <td>Triple-unit trim</td> <td>E2 55</td> <td>silver</td> <td>56392301</td> </tr> <tr> <td>FR-E2A 3</td> <td>Triple-unit trim</td> <td>E2 55</td> <td>anthracite</td> <td>56392315</td> </tr> <tr> <td>FR-Esprit A 3</td> <td>Triple-unit trim</td> <td>Esprit 55</td> <td>alu</td> <td>56393301</td> </tr> <tr> <td>FR-Esprit B 3</td> <td>Triple-unit trim</td> <td>Esprit 55</td> <td>brass</td> <td>56393305</td> </tr> <tr> <td>FR-Esprit C 3</td> <td>Triple-unit trim</td> <td>Esprit 55</td> <td>chromium</td> <td>56393315</td> </tr> <tr> <td>FR-Esprit G 3</td> <td>Triple-unit trim</td> <td>Esprit 55</td> <td>glass</td> <td>56393300</td> </tr> </table>	FR-S55 3	Triple-unit trim	Standard 55	white	56391310	FR-E2W 3	Triple-unit trim	E2 55	white	56392310	FR-E2S 3	Triple-unit trim	E2 55	silver	56392301	FR-E2A 3	Triple-unit trim	E2 55	anthracite	56392315	FR-Esprit A 3	Triple-unit trim	Esprit 55	alu	56393301	FR-Esprit B 3	Triple-unit trim	Esprit 55	brass	56393305	FR-Esprit C 3	Triple-unit trim	Esprit 55	chromium	56393315	FR-Esprit G 3	Triple-unit trim	Esprit 55	glass	56393300
	FR-S55 3	Triple-unit trim	Standard 55	white	56391310																																				
	FR-E2W 3	Triple-unit trim	E2 55	white	56392310																																				
	FR-E2S 3	Triple-unit trim	E2 55	silver	56392301																																				
	FR-E2A 3	Triple-unit trim	E2 55	anthracite	56392315																																				
	FR-Esprit A 3	Triple-unit trim	Esprit 55	alu	56393301																																				
	FR-Esprit B 3	Triple-unit trim	Esprit 55	brass	56393305																																				
FR-Esprit C 3	Triple-unit trim	Esprit 55	chromium	56393315																																					
FR-Esprit G 3	Triple-unit trim	Esprit 55	glass	56393300																																					
	<table border="0"> <tr> <td colspan="4">Dummy insert</td> <td></td> </tr> <tr> <td>FR-S 55 WB</td> <td>Dummy insert</td> <td>System 55</td> <td>white</td> <td>56398110</td> </tr> <tr> <td>FR-S 55 SB</td> <td>Dummy insert</td> <td>System 55</td> <td>silver</td> <td>56398101</td> </tr> <tr> <td>FR-S 55 AB</td> <td>Dummy insert</td> <td>System 55</td> <td>anthracite</td> <td>56398115</td> </tr> </table>	Dummy insert					FR-S 55 WB	Dummy insert	System 55	white	56398110	FR-S 55 SB	Dummy insert	System 55	silver	56398101	FR-S 55 AB	Dummy insert	System 55	anthracite	56398115																				
	Dummy insert																																								
	FR-S 55 WB	Dummy insert	System 55	white	56398110																																				
	FR-S 55 SB	Dummy insert	System 55	silver	56398101																																				
FR-S 55 AB	Dummy insert	System 55	anthracite	56398115																																					

TMS – Connection diagrams

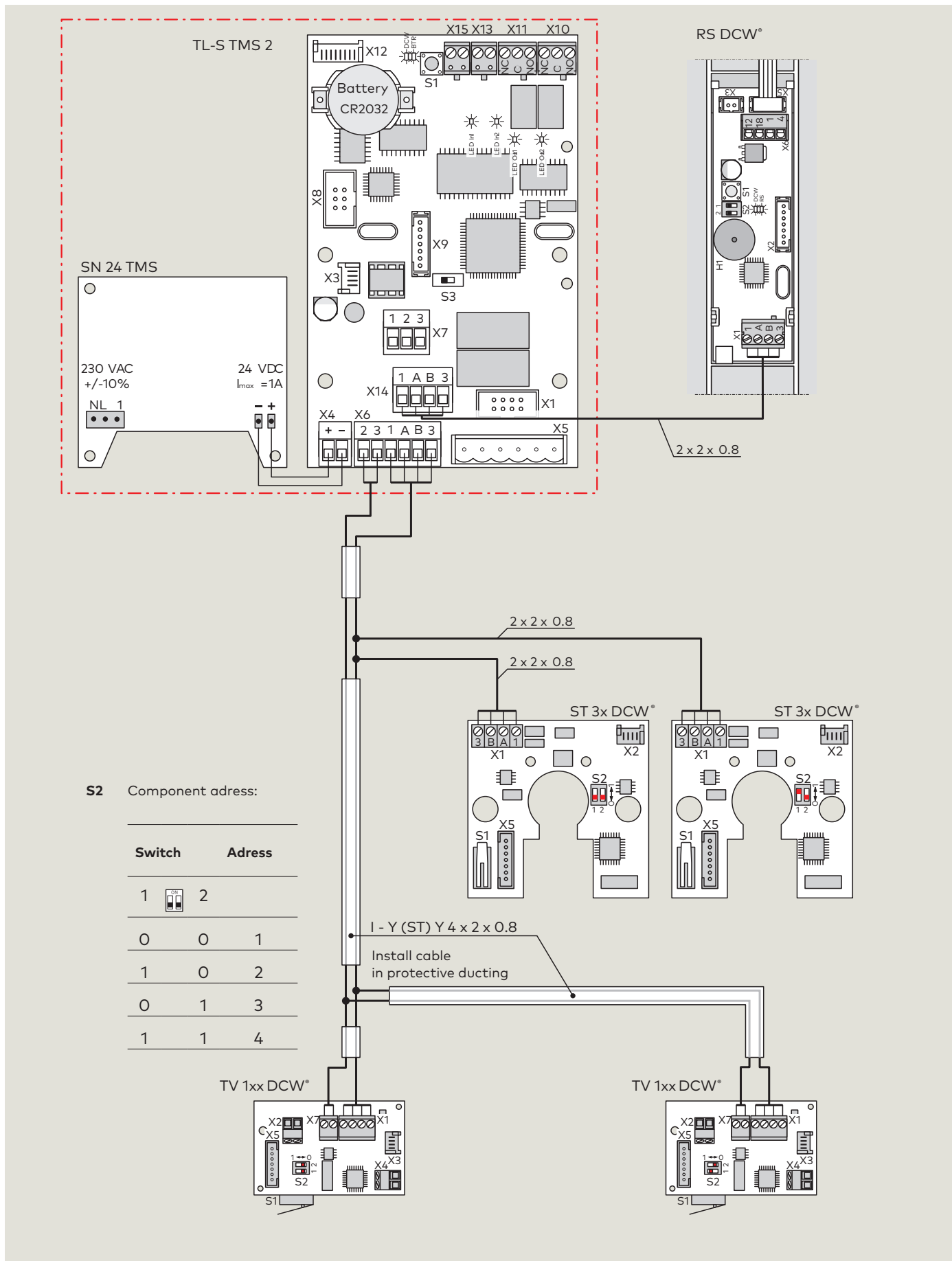

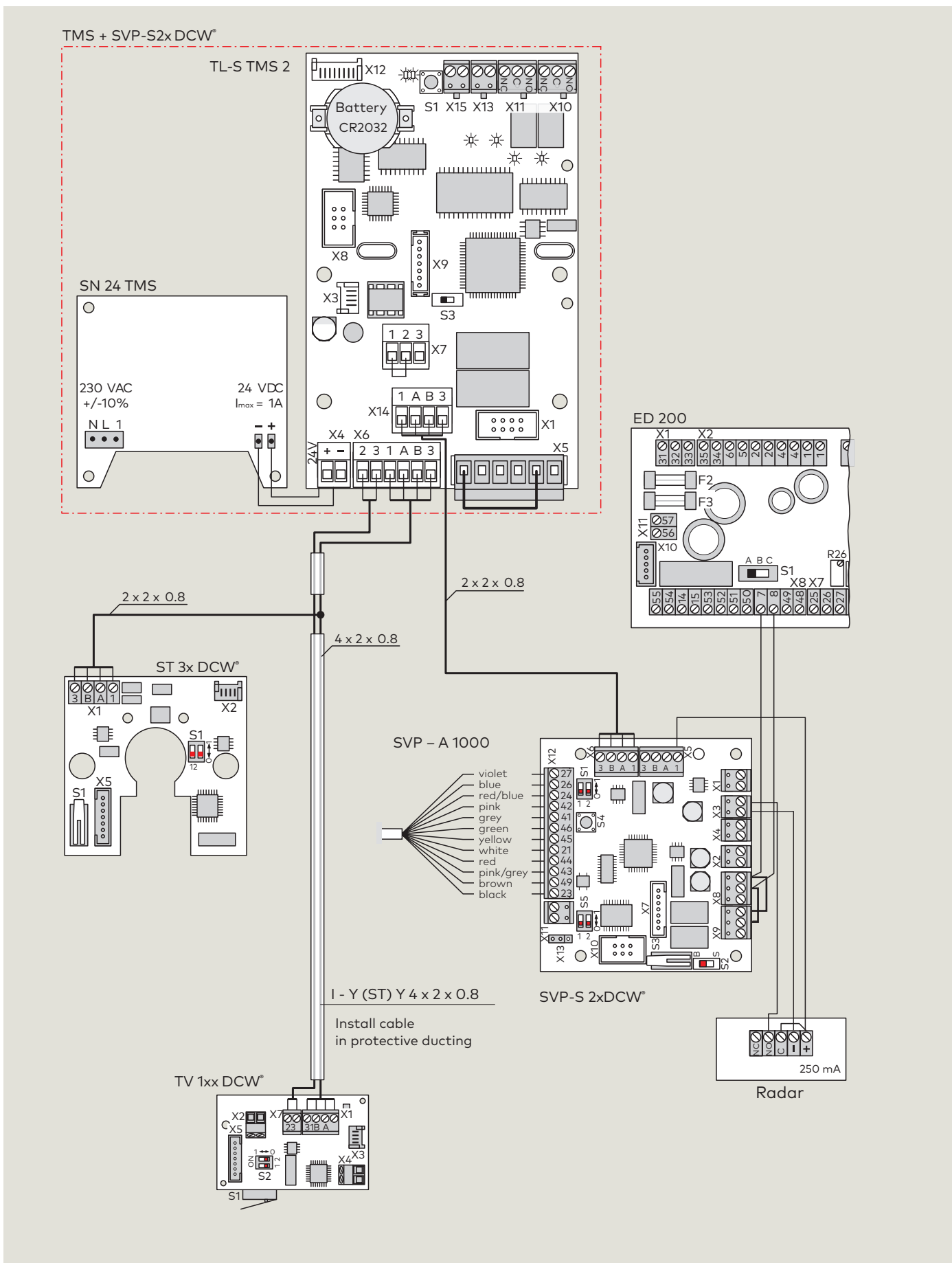

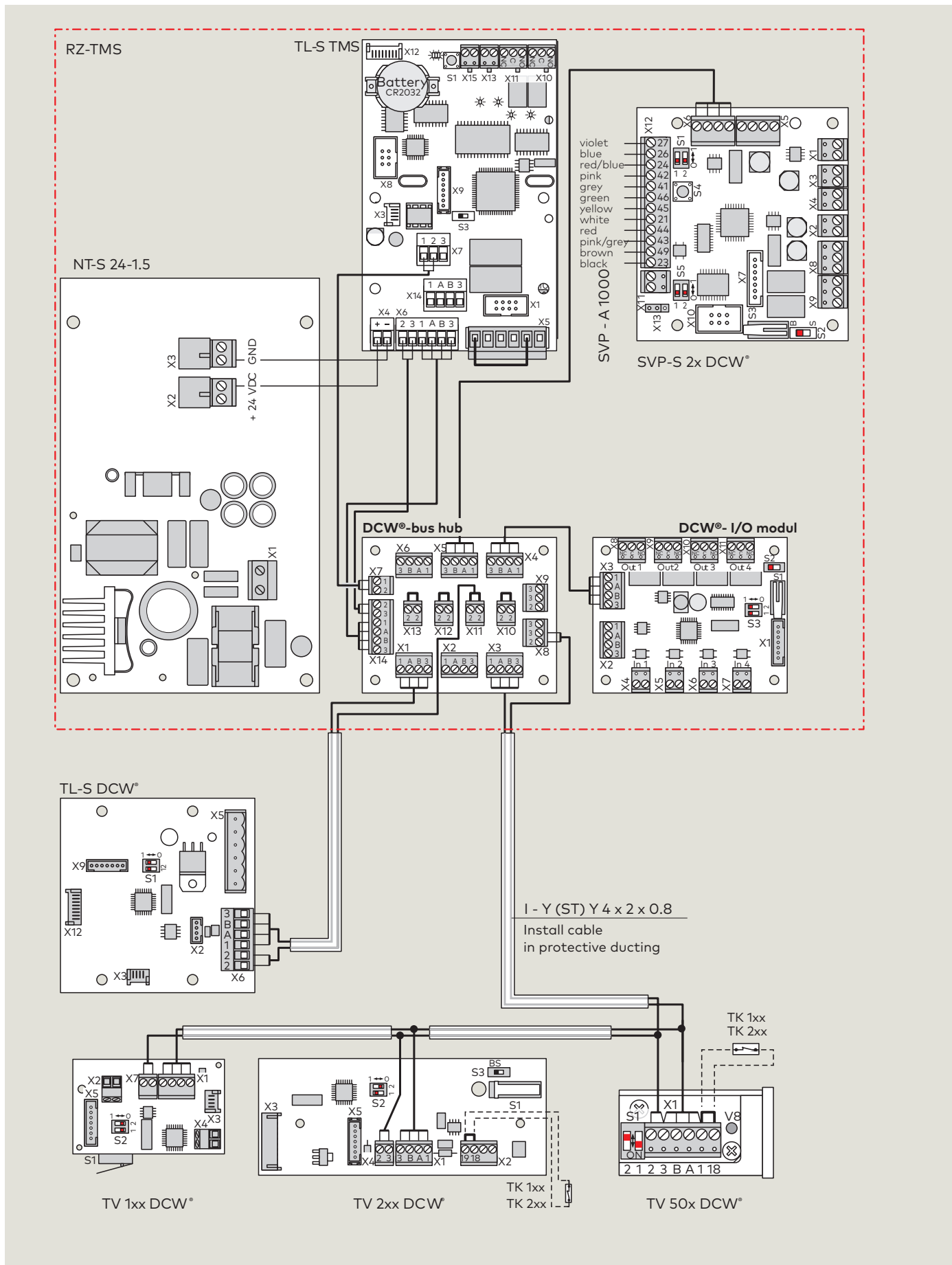

TL-NC UP + RZ-TMS + TV 1xx DCW®

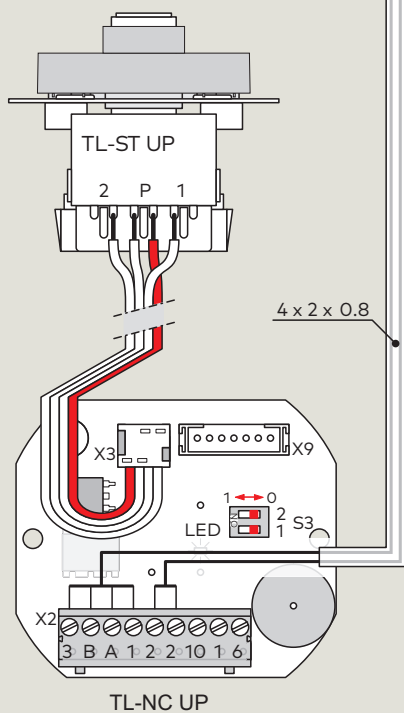
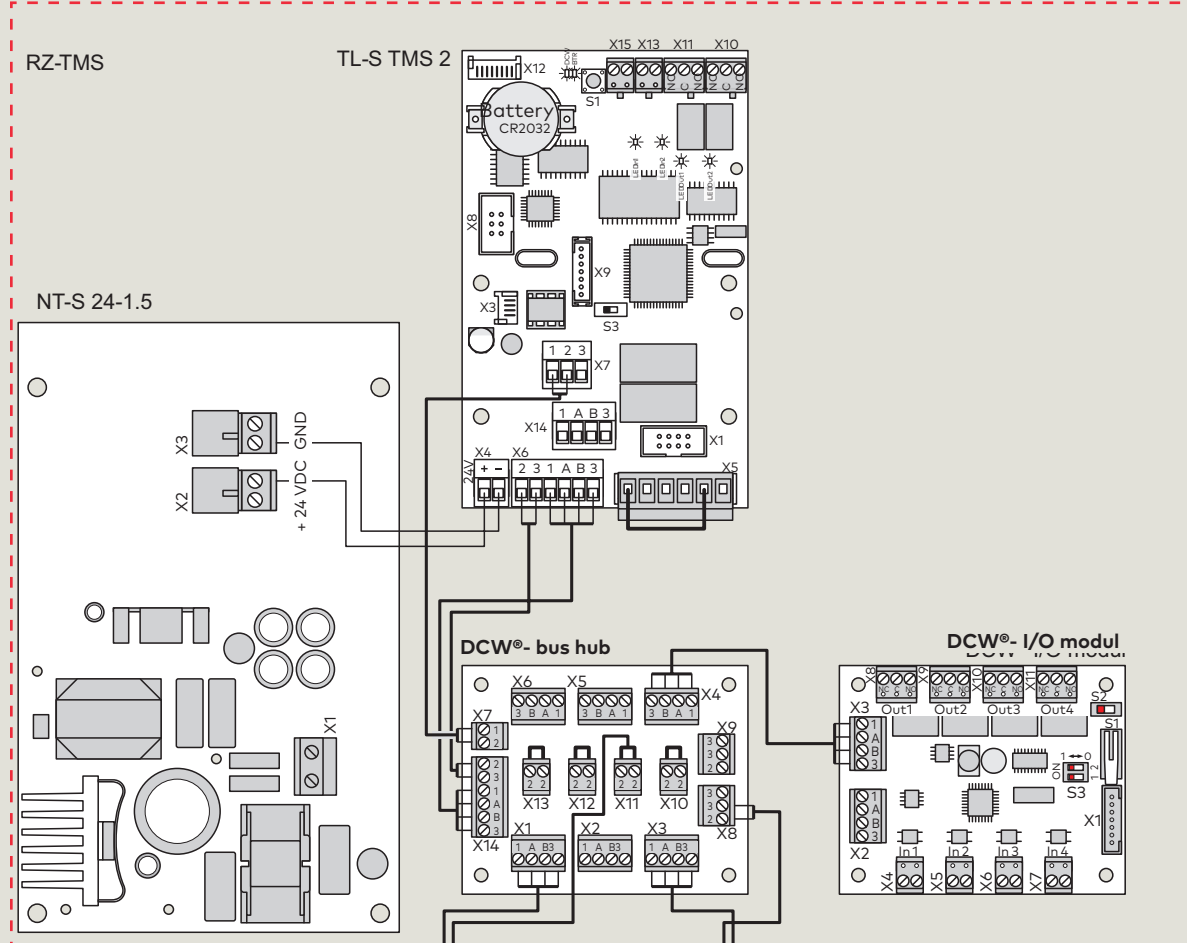

4 x 2 x 0.8

I-Y (St)Y4x2x 0.8
Install cable
in protective ducting

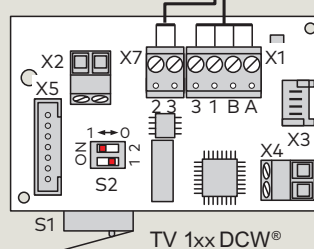

⚠ Parameter setup

128 100 #
127 101 #

Sonderfunktionen

Externe Geräte

- Notschalter ist angeschlossen (an Klemme X7)
- Rauchmelder ist angeschlossen (an Klemme X7)
- Rauchmelder ist angeschlossen (an TMS-I04)

TMS-Schlusenfunktion

ause / Eigene Funktion Kurzzweitentriegelung

From TMS firmware v3.3, no longer necessary!

S2/S3 Component address:

Switch	Address
1	2
0	0 1
1	0 2
0	1 3
1	1 4

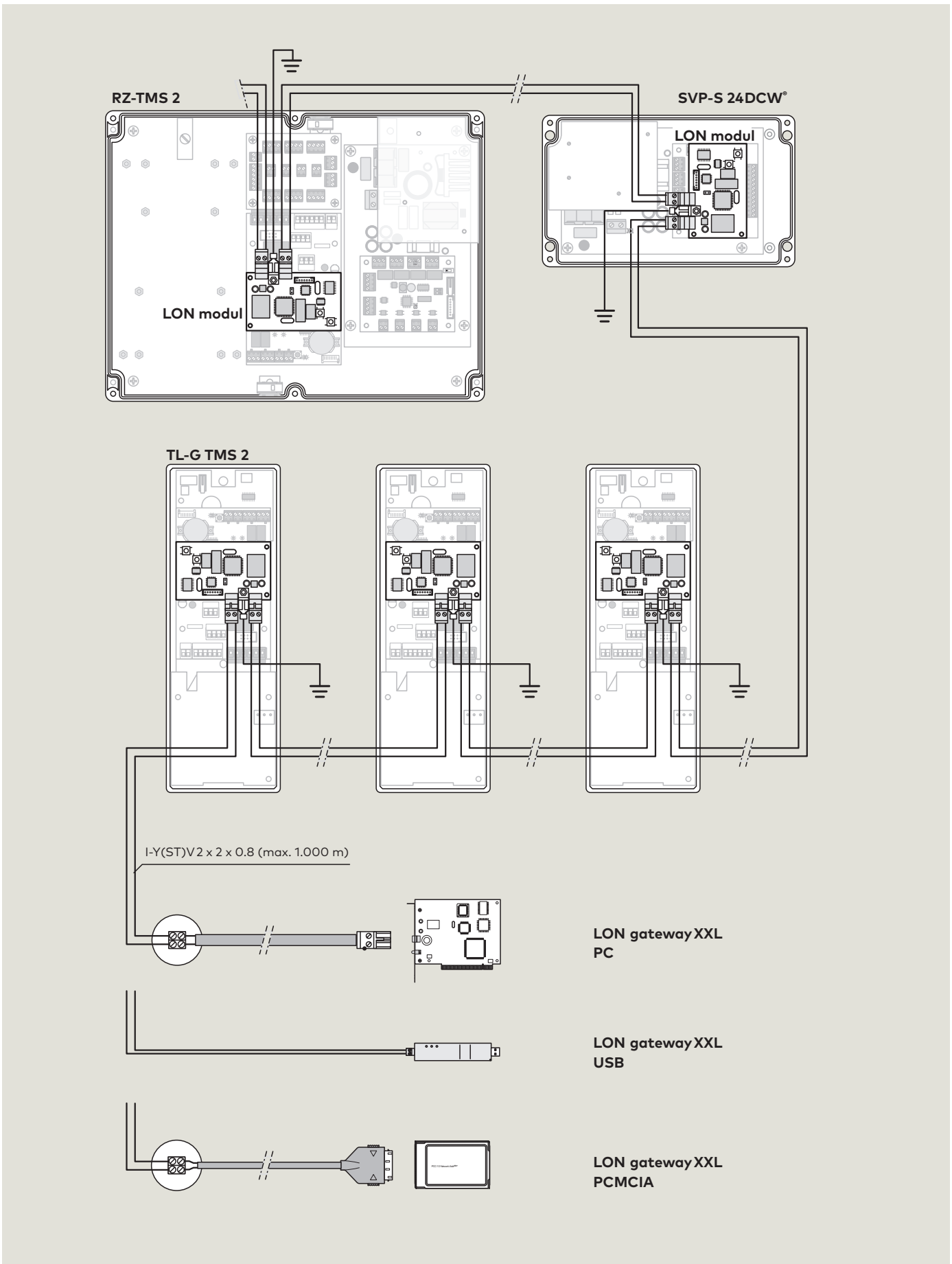

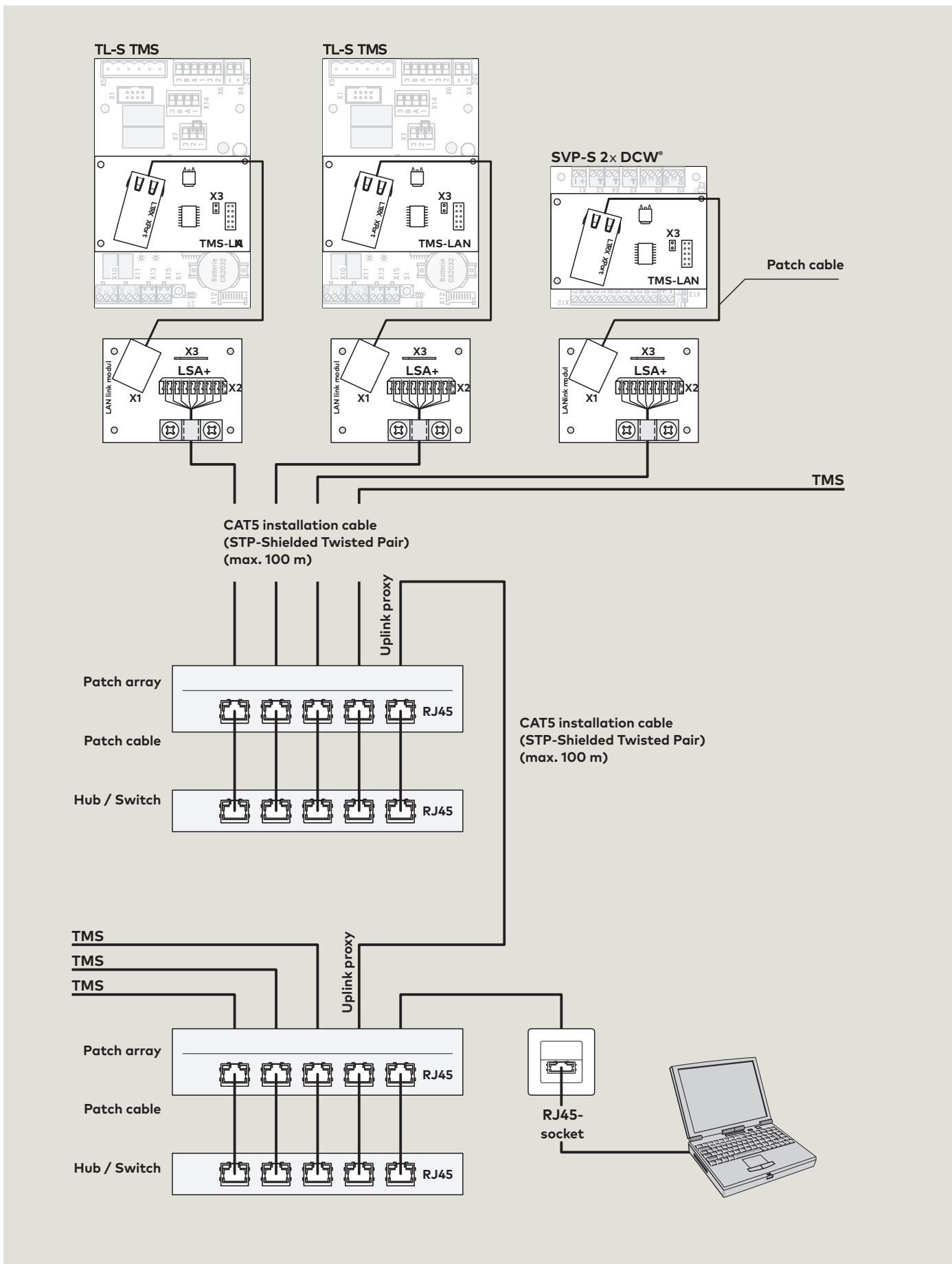

TMS + TE 3x

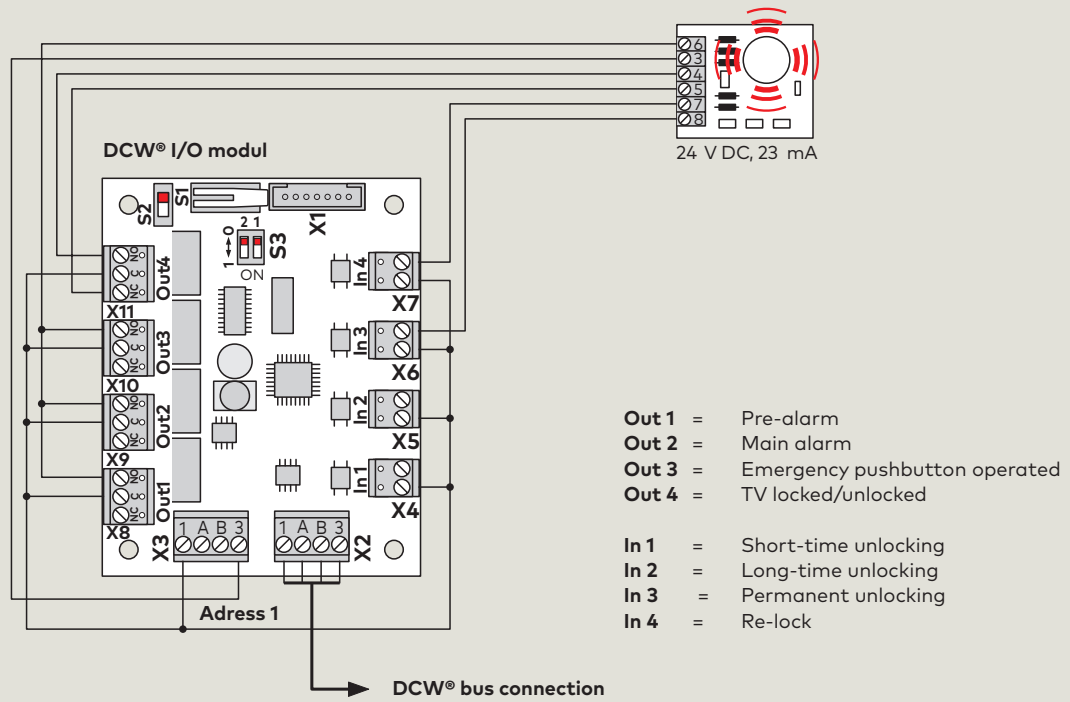

TMS + SVP 4xxx/6xxx

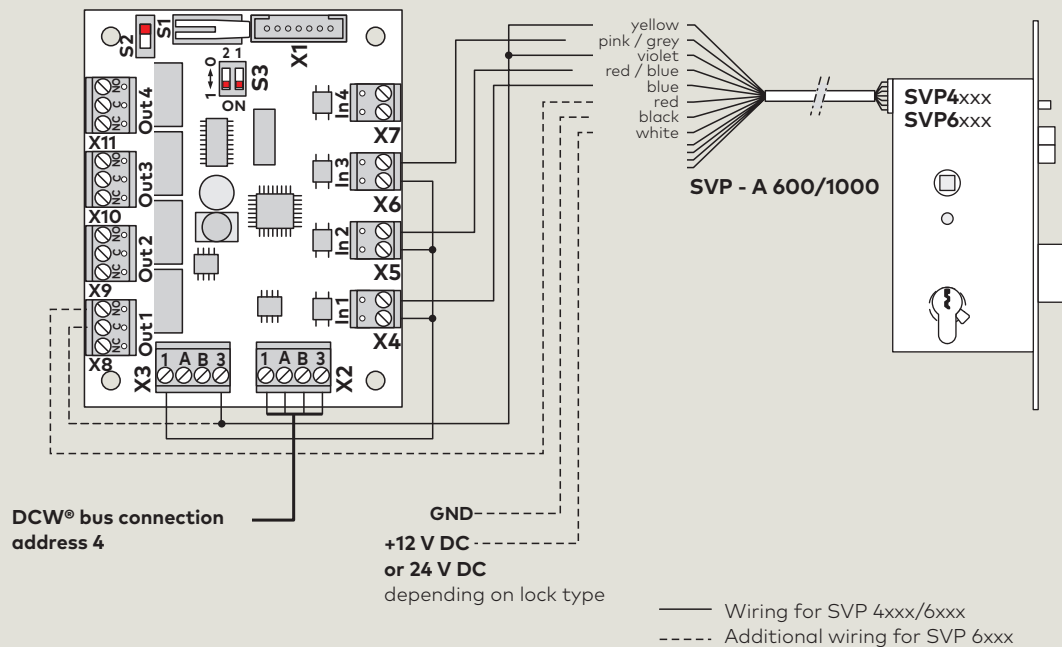

Safety information

dormakaba emergency exit systems are designed, developed and manufactured in accordance with the latest state of the art and in line with recognised technical safety regulations and standards. They meet the requirements of the code of practice entitled "Requirements for electrical locking systems on doors in emergency escape routes" (EltVTR, December 1997 edition) published in Bulletin 5/98 of the German Institute for Building Technology, Berlin. Test and approval certificates issued by the MPA NRW (Material Testing Authority) and VdS Cologne (Association of Property Insurers) are available.



Compliance with the following instructions by the installer and operator is imperative to ensuring that these devices do not impede unhindered escape of persons in the event of a hazard-related emergency.

Usage

Emergency exit systems are electrical locking systems for doors in emergency exits and escape routes. They are designed in order to prevent improper or unauthorised usage of the associated access points. When installing and using dormakaba emergency exit systems, compliance with the technical data and the requirements emanating from prevailing local conditions is essential.

Preliminary building enquiry / Planning application / Approval procedure – The German example –

Emergency exit systems do not fall under the compass of current building law and approval is subject to a discretionary exemption in the sense of § 67 Musterbauordnung [Outline building regulations]. In addition, the requirements according to DIBt 5/98 should also be regarded as ancillary regulations that need to be incorporated within the building approval process for the project in hand.

Planning and installation

A dormakaba emergency exit system consists at least of the components TMS door terminal/central control station and TV electrical door locking element. Depending on the design of the emergency exit control, the following components may also be connected to the system: Key switch or access control system, monitoring and control unit, emergency escape lock with automatic locking action (switch-monitored or motor lock), flashing lamp or external alarm siren, automatic swing door operator, power pack with emergency power supply, fire alarm and/or hazard alert system, smoke switch.



The electrical door locking element may only be used on emergency exit doors in conjunction with products approved by dormakaba.

The door terminal (local system release/emergency opening of door) should be mounted in the immediate vicinity of the door handle so that the centre of the emergency pushbutton is at a height of 850 mm to max. 1200 mm above the finished floor level.

The emergency pushbutton must be indicated with an adhesive label showing the inscription "Emergency Exit". The adhesive label should be attached such that the arrow points to the emergency pushbutton.

In buildings with automatic fire extinguishing equipment, fire alarm or other hazard alert systems, the emergency exit doors with electrical anti-tamper protection must be automatically released for escape on response or activation of these systems.

If, during building usage, there is a constantly manned central control centre with a direct view of the emergency exit doors, the emergency exit release/de-activation switching operation can also be performed from this position.

The properties and characteristics of the fire and smoke rated doors (fire resistance time, smoke retention/sealing function and automatic closing action) must not be impaired by the installation of the electrical door locking device.

In Germany, modifications to fire doors or other fire barriers which are necessary for the installation of an electrical door locking element and which go beyond the modifications indicated as permissible in Bulletin 1/1996 of the DIBt, require general building approval and/or agreement of the authorities responsible in each individual case. Consult local/national authorities for guidance.



Only use dormakaba spare parts or dormakaba approved accessories.

Any work on electrical equipment not operating on protective low voltage must always be performed by suitably qualified electricians.

Installation, commissioning and maintenance work may only be performed by qualified personnel authorised by dormakaba.

The keys for the door terminal and emergency exit control box must be kept secure. Keys for products not operating on protective low voltage may only be handed over to suitably qualified electricians.

Standards and regulations

Compliance with all relevant national or regional regulations, standards, guidelines and directives (latest edition in each case) must be ensured.

The following publications provide a useful general regulatory framework for ensuring system safety:

- DIBt bulletin 5/98 – "Requirements for electrical locking systems on doors in emergency escape routes" (EltVTR),
- DIBt bulletin 1/96 – Modifications to fire doors and fire rated barriers.
- DIN VDE 0100, 0800, 0815
- Regulations governing the installation of electrical equipment
- DIN 0833 – Part 1-3
- Regulations governing hazard alert systems for fire, burglary and robbery detection and alarm
- German building regulations list A, Part 1
- Special building regulations
- prEN 13637 – Building Hardware – Electrically controlled emergency exit systems

Country-specific regulations, standards and guidelines must be observed.



www.dormakaba.com

dormakaba Deutschland GmbH
DORMA Platz 1
58256 ENNEPETAL
Germany
T: +49 2333 793-0
F: +49 2333 793-4950

WN 053 557 51532, 12/16, TMS, D, x, DMS, xx/13
Subject to change without notice