



## PASSIVE INFRARED EGRESS SWITCH (PIR)

### Mounting Instructions

1. Select a mounting location over the center of the door or doors to be covered. (The target must walk directly toward the detector.)
2. The detector may be mounted on the ceiling, wall or door frame. It may be surface-mounted or mounted to a keyswitch plate with a size "D" hole.  
**NOTE:** The 915 is not tall enough to completely cover a single-gang box. Where aesthetics are important, it is recommended that the detector be mounted over a standard single-gang plate.
3. The mounting height range is from 7 to 15 feet above the floor. Ensure all wiring is unpowered before routing.
4. Remove back cover from the detector by inserting the head of a small straight-edge screwdriver into the locking tab and pry off.  
**NOTE:** Once the back cover is removed, the front cover and detector module will also separate.
5. Route the wiring as necessary through the wiring entrance (see Fig. 1). For surface wiring, use the breakout wiring entrance on the front cover (at the same end as the wire entrance).
6. Loosely mount the back cover to the mounting surface. Use the supplied mounting screws.
7. Mount the detector module to the back cover. Aim the detector for the desired coverage.  
**NOTE:** The 915 is not designed as a primary means of exit for emergency egress applications.

### Wiring Instructions

1. Connect the wiring harness (provided) to the wire plug on the circuit board as shown in Fig. 2.  
**CAUTION:** Only apply power after all connections have been made and inspected.  
**NOTE:** Excess wiring may be coiled behind the back cover along the channels provided.

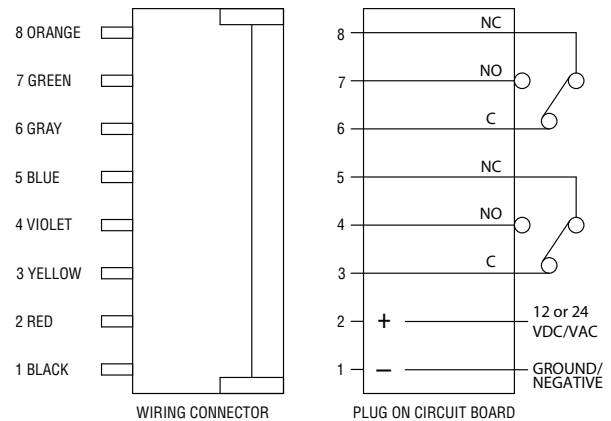

Fig. 2 Connector to Plug Orientation (Default Switch Settings)

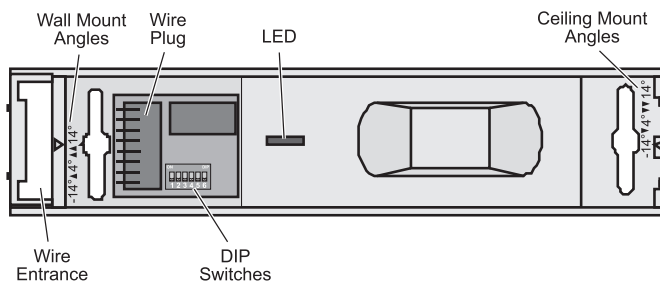

Fig. 1 Passive Infrared Egress Switch (front view)

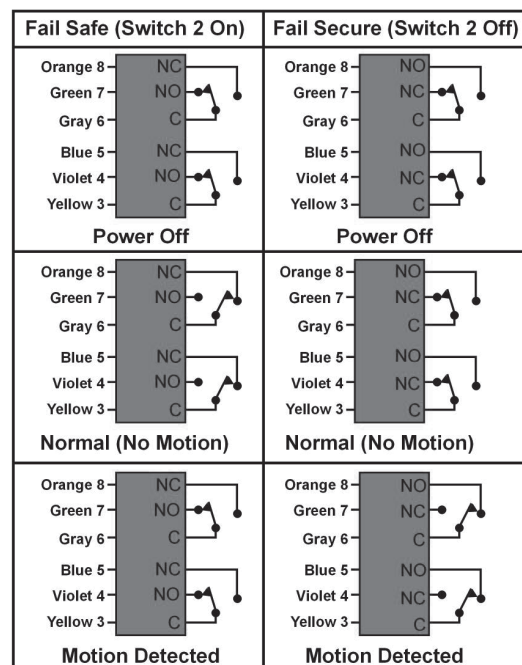

Fig. 3 Relay Contact Wiring

# 915 Passive Infrared Egress Switch Installation Instructions (Continued)

Input Power	12 or 24 VDC: 35 mA at 12 VDC when in alarm 38 mA at 24 VDC when in alarm 12 or 24 VAC: 42 mA at 12 VAC when in alarm 48 mA at 24 VAC when in alarm
Standby Power	There is no internal standby battery. Provide 38 mAh for each hour of standby time required.
Relay	Two Form "C" contact sets rated 2.0 A at 30 VDC or VAC maximum for DC resistive loads.
Temperature	-20°F to +120°F (-29°C to +49°C). For UL and C-UL certified installations, the temperature range is +32°F to +120°F (0°C to +49°C.)
Humidity	0-95% non-condensing
Dimensions	6.25"W x 1.5"H x 1.5"D

## Configuration

Use the on-board DIP Switches to configure the operation of the detector. Refer to Figure 4 for proper switch positioning.

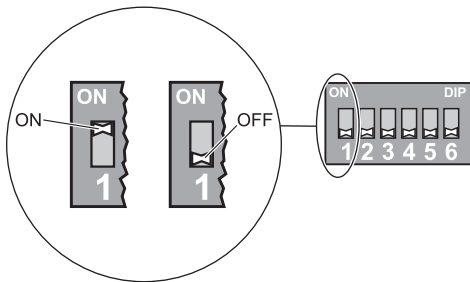

Fig. 4 Dip Switch ON/OFF Positions

## Resettable/Non-resettable Timer Selection

DIP Switch 1 determines if the relay resets at the end of latch time, or if latch time is extended by additional motion. Refer to Table 1 and Figure 4 for more information.

- **Resettable** (use when bypassing a 24-hour contact): The relay will activate when the detector first sees motion. Any additional motion restarts the latch timer so that the relay deactivates only when the detector is no longer seeing motion and the latch time has expired.
- **Non-resettable** (use for an access control system): The relay will activate when the detector first sees motion and deactivate at the end of latch time even if motion is still present.

Switch 1	Function
OFF	Non-resettable
ON	Resettable (Default)

## Relay Mode

DIP Switch 2 selects the relay mode. This allows you to select a fail safe by default, or a fail secure mode. Refer to Table 2 and Figure 4 for more information.

- **Fail Safe:** In the event of a power loss, the REX (Request to Exit) detector releases the device connected to it (for example, magnetic door lock or electric door strike.)
- **Fail Secure:** In the event of a power loss, the REX detector does not release the device connected to it (for example, magnetic door lock or electric door strike).

In Fail Secure Mode, the REX detector shall be installed in a manner that does not impair the intended operation of panic hardware used in conjunction with the REX detector.

Failure Secure mode must be authorized by the local Authority Having Jurisdiction (AHJ).

Switch 2	Function
OFF	Fail Secure
ON	Fail Safe (Default)

Refer to Figure 3 Relay Wiring Options.

## LED Enable/Disable

DIP Switch 3 selects whether the on-board LED is enabled or disabled. If enabled, the LED operates normally when motion is detected.

Switch 3	Function
OFF	Disabled
ON	Enabled (Default)

When LED is enabled, it will flash on and off when first powered up. Once the Flashing LED stops, the REX is ready to be used.

# 915 Passive Infrared Egress Switch Installation Instructions (Continued)

## Latch Time

DIP Switches 4, 5 and 6 set the relay latch time. Latch time is adjustable from 0.5 sec to 64 sec. It indicates the amount of time the relay can remain active after the detector first sees motion.

Time (sec)	Switch 4	Switch 5	Switch 6
0.5 (Default)	OFF	OFF	OFF
1	OFF	OFF	ON
2	OFF	ON	OFF
4	OFF	ON	ON
8	ON	OFF	OFF
16	ON	OFF	ON
32	ON	ON	OFF
64	ON	ON	ON

## Coverage

Figure 5 and 6 show the standard patterns for a Wall-Mounted Unit. Install the unit over the center of the door.

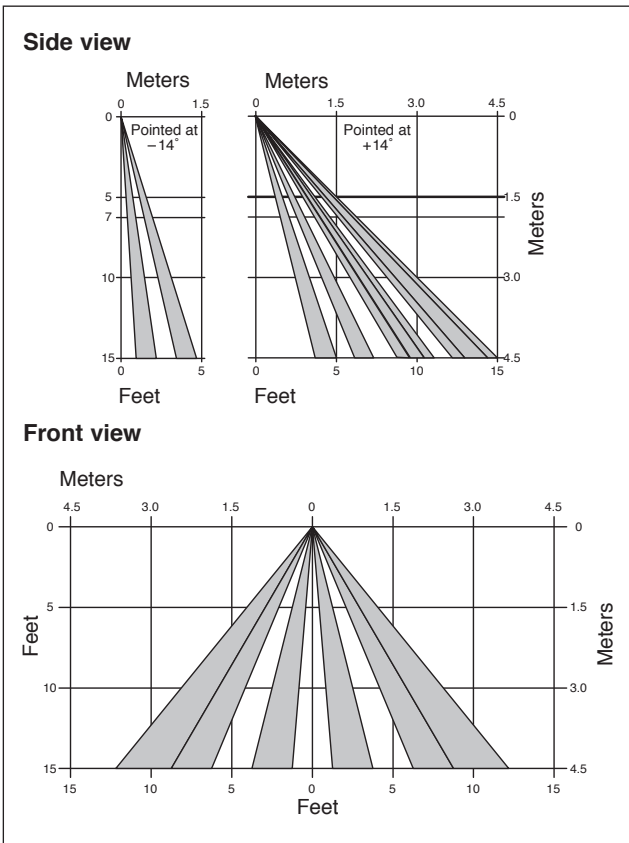

Fig. 5 Standard Patterns for a Wall-Mounted Unit

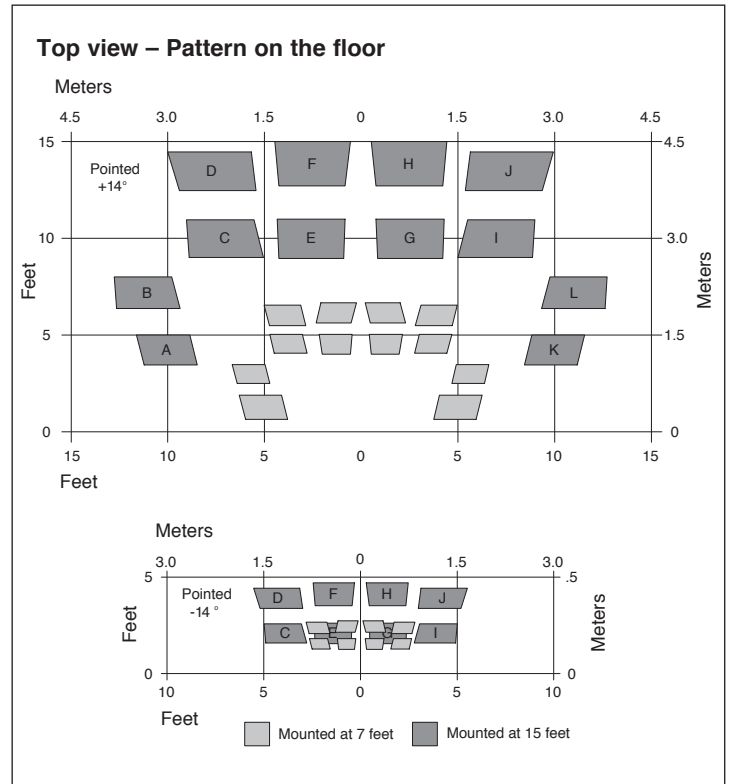

Fig. 6 Standard Patterns for a Wall-Mounted Unit

## Set-up and Testing

1. Apply power to the unit and wait three minutes for detector to settle.
2. Walk directly through coverage area toward the door to test the unit.
3. Aim the detector up or down to obtain the proper coverage. Tighten the mounting screws after aiming the detector.
4. Check the relay latch time and adjust, if necessary.
5. Replace the cover and walk test one more time to ensure coverage has not changed.

## Sensor Patterns

For double doors with a center post, mount a unit over the center of each door and wire outputs so either detector will permit egress. If no center post exists, alternative mounting options should be considered to move the center of the pattern away from the gap between the doors. (A foreign object could be inserted through the gap and interpreted as a request to exit.) Mounting the unit to the ceiling away from the door is one possibility. Longer objects might still be used to enter the coverage pattern; however, this type of entry would be much more difficult.

**NOTE:** To reduce the probability of interference by foreign objects, mask out the inside zones (K & L of one detector, and A & B of the other). Masking wedges are included with the unit's kit. Snap the wedges into place on the outer surface of the lens. The wedges will eliminate zones A, B, K and L.

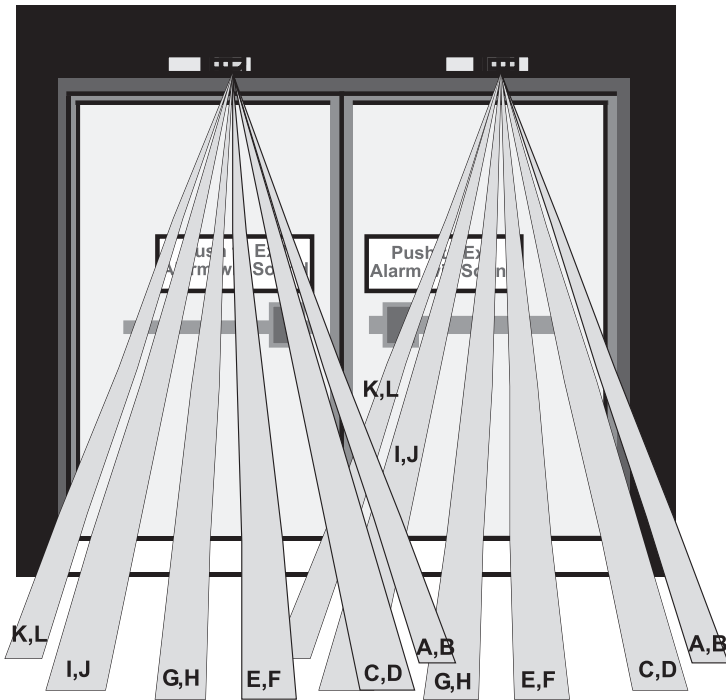

Fig. 7 Masking a Dual Mount