

The background of the page is a high-quality photograph of DORMA panic hardware. It shows a horizontal metal bar with several components: a small rectangular handle on the left, a larger curved handle in the center, and another curved handle on the right. A small rectangular plate with the DORMA logo is also visible on the right side. The hardware is set against a light gray background.

PHA 2000  
PHB 3000  
EXIT PAD  
—

Panic Hardware  
in Contur Design

# THE MODULAR DORMA PANIC HARDWARE-SYSTEM IN CONTUR DESIGN

Prior knowledge of how to open the escape door is not expected.

**DANGER OF PANIC**

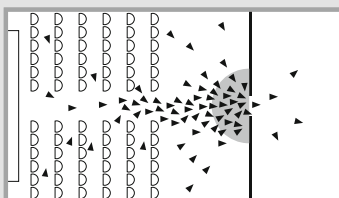

## EN 1125

Panic exit devices operated  
by a horizontal bar

PHA 2000



PHB 3000



### Approval certification

The Panic Hardware products of the series PHA 2000 and PHB 3000 have been tested to and certified compliant with EN 1125. All products meet the requirements of Annex ZA to EN 1125 and are therefore qualified to bear the CE mark of conformity.

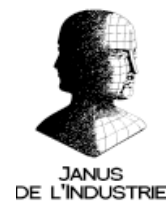

# ADVANCED, HIGH-SPEC FITTINGS FOR EMERGENCY EXIT DOORS

Prior knowledge of how to open the escape door is expected.  
NO DANGER OF PANIC

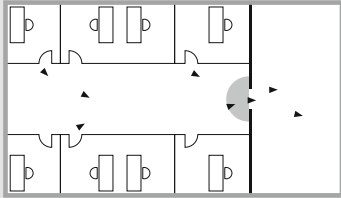

With this system, DORMA is able to offer a comprehensive range of high-quality panic hardware fittings with horizontal and vertical locking for doors in emergency exits and escape routes – applications in which safety, reliability and aesthetic attractiveness are indispensable requirements. DORMA's PHA and PHB products cover in full the hardware requirements that

arise in public-frequented facilities such as hospitals, universities and schools, concert halls, shopping malls, hotels and administrative buildings. Whether office suites or apartment blocks, in buildings where there is generally no public pedestrian traffic, the Exit Pad provides the ideal answer. For both series, the same external DORMA PHT fittings are used.

EN 179

Emergency escape devices with exit pad

## Exit Pad



## CONTENTS

PHA 2000/PHB 3000	Features and functions	4
PHA 2000	Dimensions	6
	Applications and fixing details	7
PHB 3000	Dimensions	8
	Applications and fixing details	9
PHA 2000/PHB 3000	Components	10
Exit Pad	Features and functions	16
	Dimensions	18
	Applications and fixing details	19
	Components	20
Glass Kit	Features and functions	22
	Applications and fixing details	23
	Components	28
PH Accessories	Applications and fixing details	30
	Components	32
PHT	External fittings	34

### Approval certification

The emergency exit devices of the Exit Pad series are tested to and certified compliant with EN 179. All products meet the requirements of Annex ZA to EN 179 and are therefore qualified to bear the CE mark of conformity.

# PHA 2000 / PHB 3000 PRACTICAL PANIC HARDWARE FOR MANY DOOR SITUATIONS

With the series PHA 2000 crossbar and the series PHB 3000 pushbar combined with the universally applicable PHT external fittings, DORMA is able to offer a range suitable not only for narrow-stile doors but also timber and similar full-face doors.

The wide security latchbolt engages in a keeper that is normally mounted on the frame. This ensures that the latch is extremely easy to mount and that the door is also securely locked.

## Benefits

### For the trade

- Modular system for reduced storage costs
- Non-handed
- Universal use of PHT external fittings

### For the installer

- Straightforward fixing
- Easy adjustment to different door widths and heights

### For the architect/specifier

- For horizontal and vertical panic lock mechanisms
- External fitting with DORMA lever handle or knob
- Electrical functions for special applications

### For the user

- Simple operation
- Excellent quality ensures long lifespan
- Universal electric strike

Data and features	PHA 2000			PHB 3000		
	1-point	2-point	3-point	1-point	2-point	3-point
Modular system	●	●	●	●	●	●
Standard (non-expandable)	–	●	–	●	–	–
Standard doors (single-leaf/double-leaf)	●	●	●	●	●	●
Fire and smoke check doors (single-leaf/double-leaf) <b>F</b>	●	●	●	●	●	●
Glass doors	●	●	●	–	–	–
Door width	≤ 1000 mm	●	●	●	●	●
	≤ 1300 mm	●	●	●	●	●
Door height	≤ 2270 mm	–	●	–	●	●
	≤ 3400 mm <sup>1)</sup>	–	●	–	●	●
Max. door leaf weight in kg	200	200	200	200	200	200
Non-handed design	●	●	●	●	●	●
Dogging device <sup>2)</sup>	●	●	●	●	●	●
Security anti-thrust latch	for standard doors	–	–	–	–	–
	for fire and smoke check doors	●	●	●	●	●
Unlocking via electric strike	○	○	○	○	○	○
Monitoring switch on actuating bar	○	○	○	○	○	○
PHT external fittings						
For standard doors and fire and smoke check doors	●	●	●	●	●	●
For door leaf thicknesses up to 60 mm						
Extended handle spindle and bolts for door leaf thicknesses of 60 – 105 mm	○	○	○	○	○	○
Approved to EN 1125	●	●	●	●	●	●
CE mark for construction products	●	●	●	●	●	●

● Yes – No ○ Option

<sup>1)</sup> Doors higher than 2500 mm lie outside the scope of EN 1125.

<sup>2)</sup> Not for Fire and smoke check doors.

## **F** Approval certification

The panic hardware products marked with an **F** are approved for use with fire and smoke check doors. Approval certification for the fire and smoke check door

in conjunction with the DORMA panic hardware product is additionally required in some countries – check local regulations.

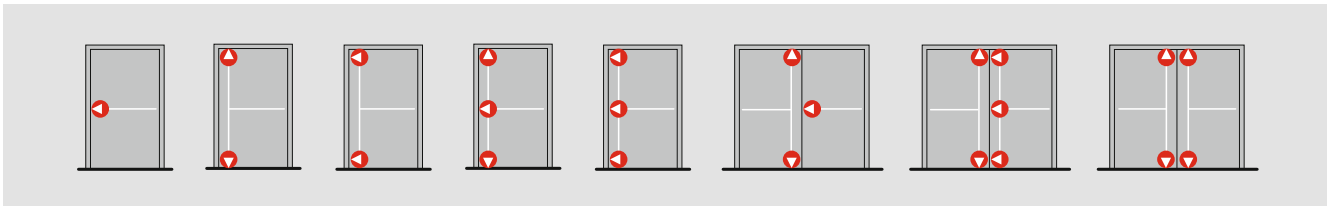

The modular panic hardware system

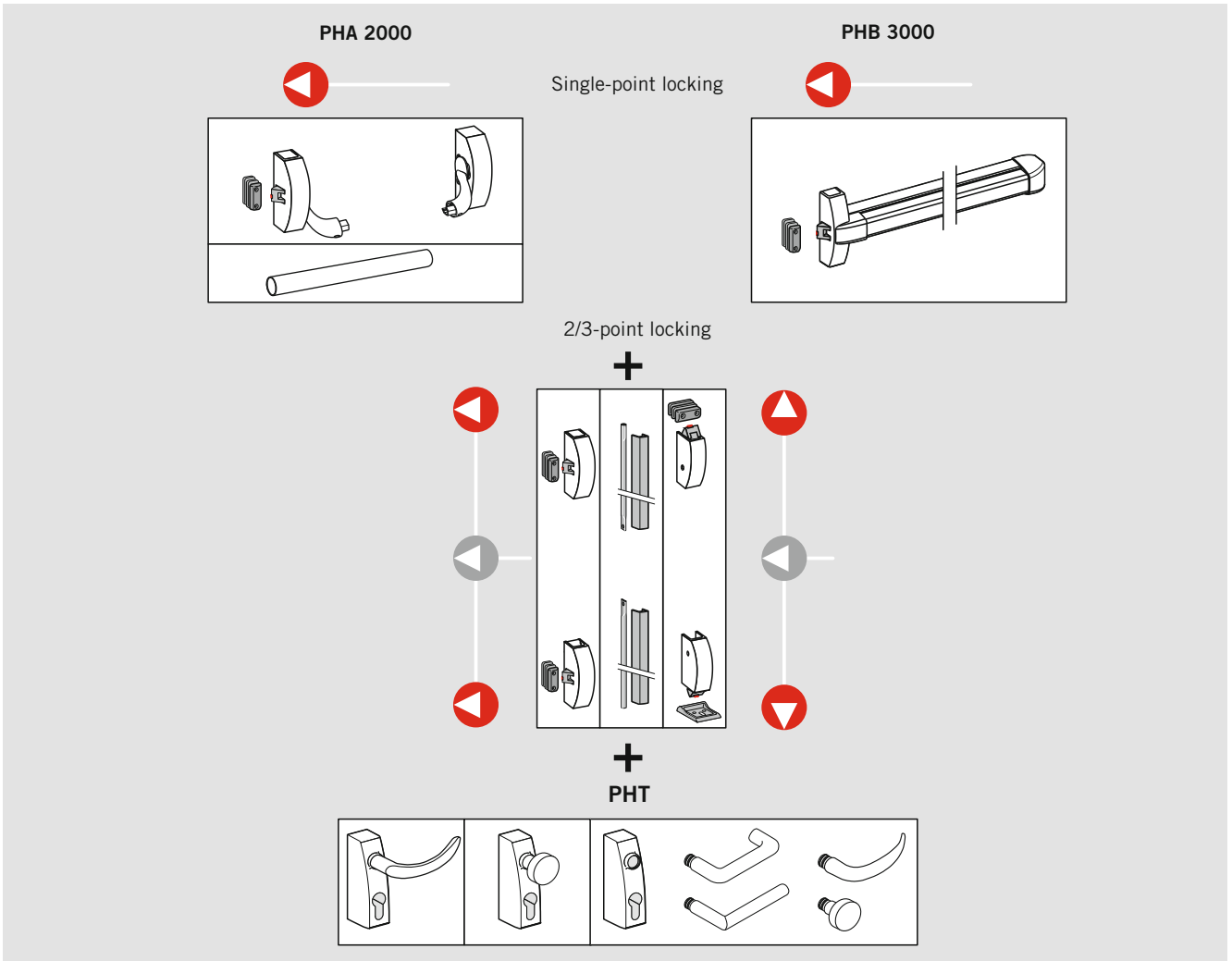

Security anti-thrust latch

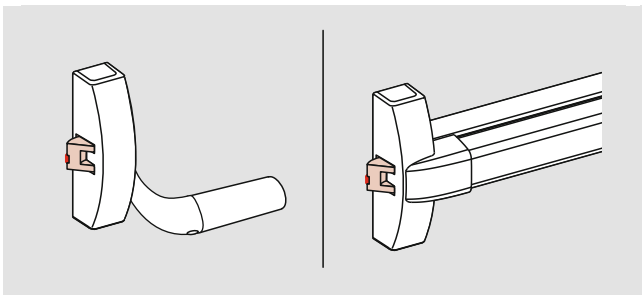

The security anti-thrust latch prevents the latch from being pushed back by unauthorised means when it is in the closed position.

Dogging device

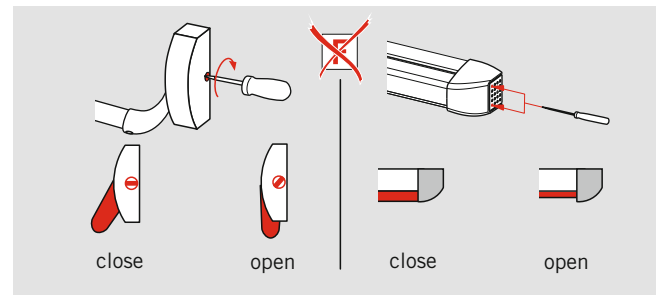

The dogging device serves to hold the latch in its retracted position so the door is freely accessible.

# PHA 2000

## Single-point locking

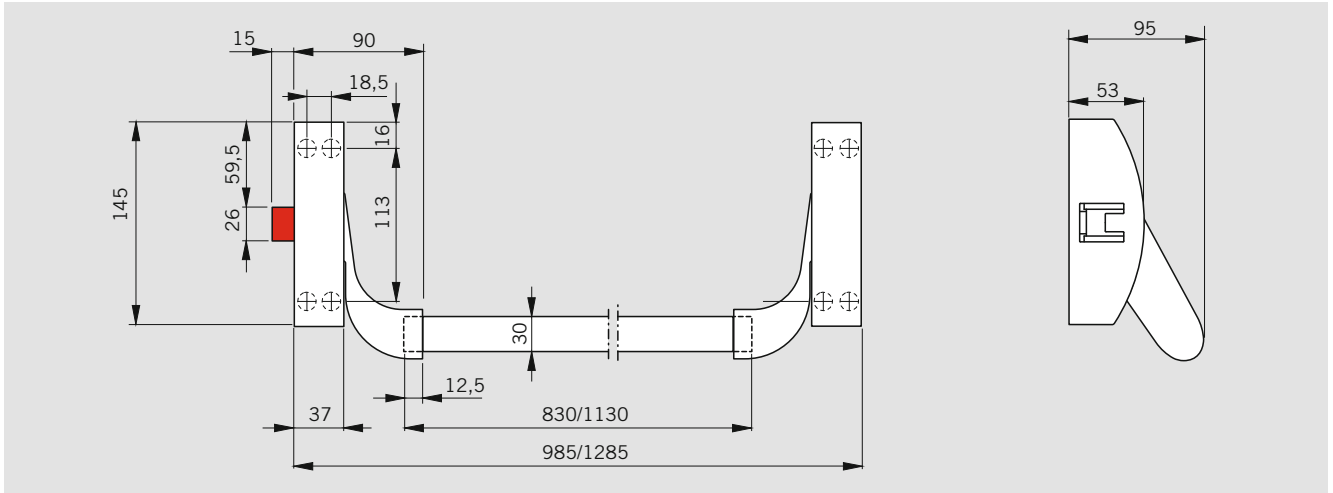

## 2/3-point locking

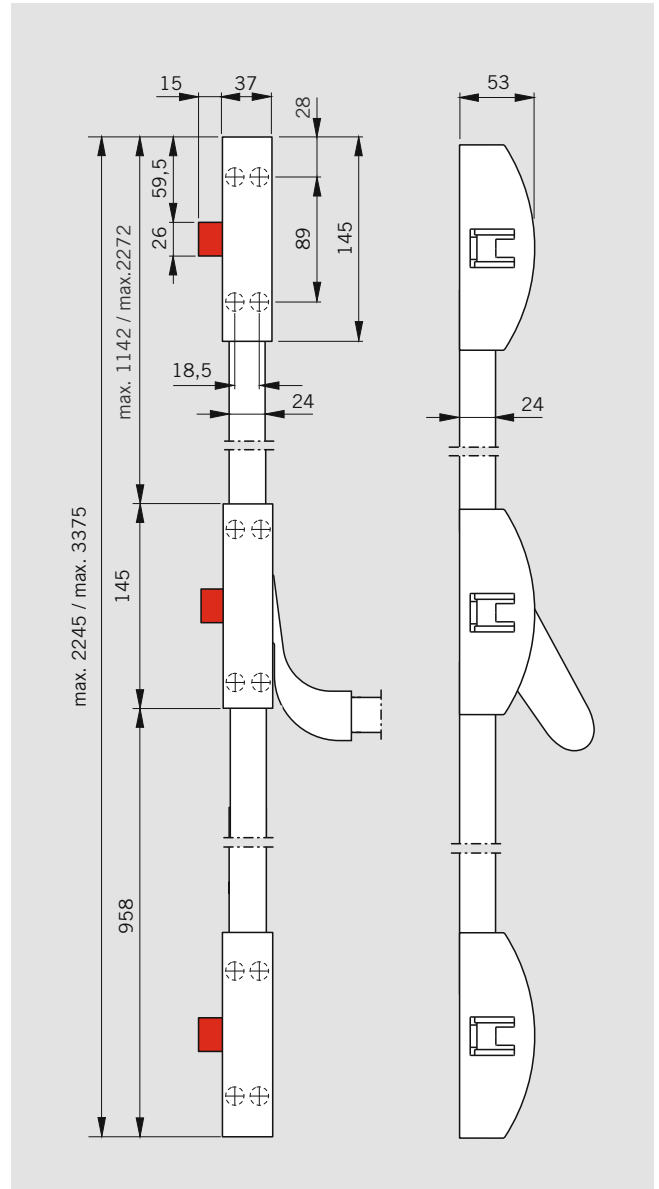
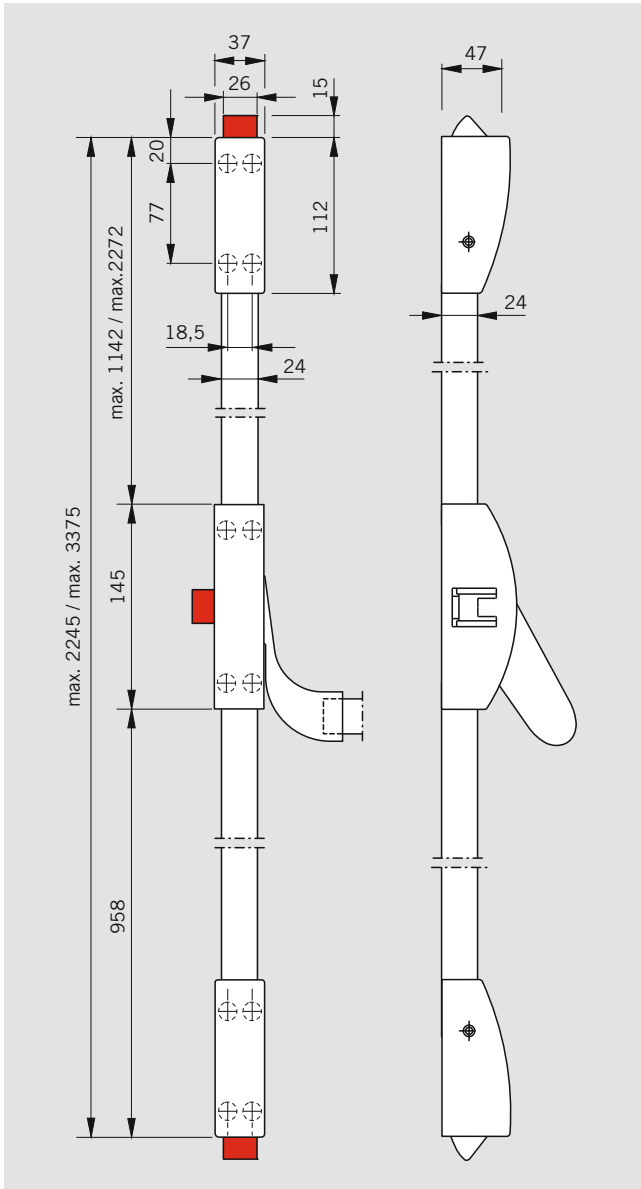

Applications and fixing details

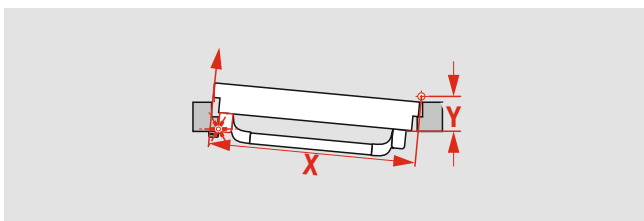
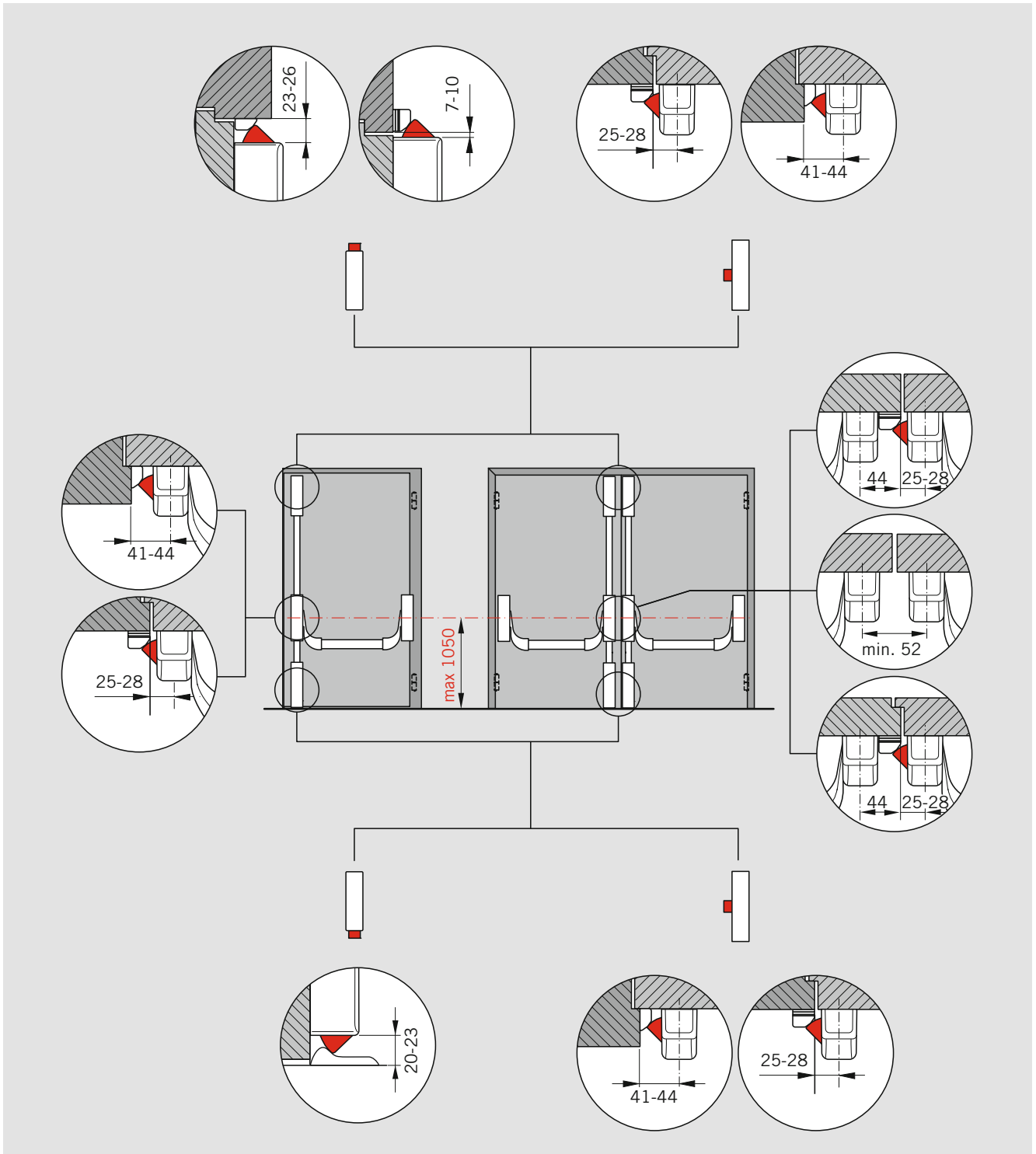

**Note**

It may be the case that the exit device cannot be installed based on standard measurements where the door situation is extreme, e.g. with a door width  $X < 1000$  mm combined

with a hinge offset  $Y > 90$  mm. DORMA will be glad to provide you with installation suggestions on request.

# PHB 3000

## Single-point locking

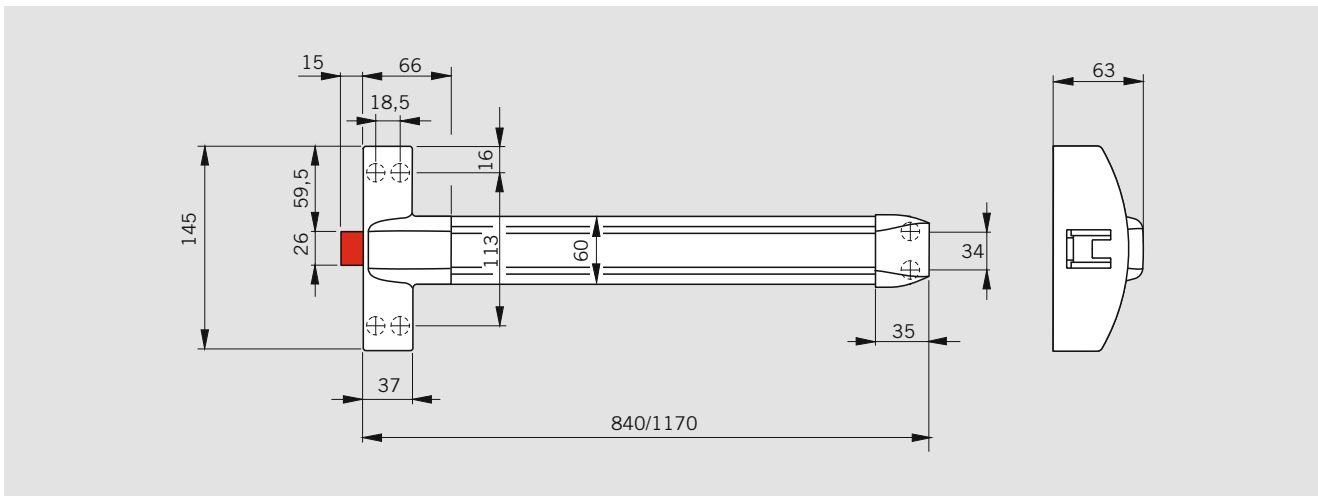

## 2/3-point locking

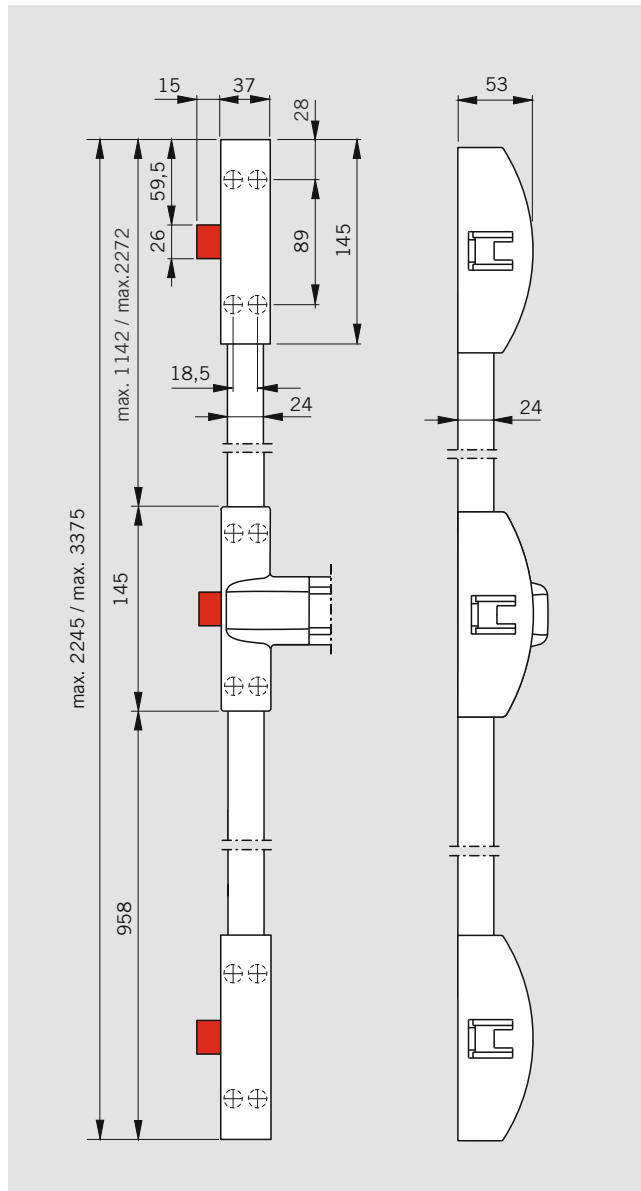
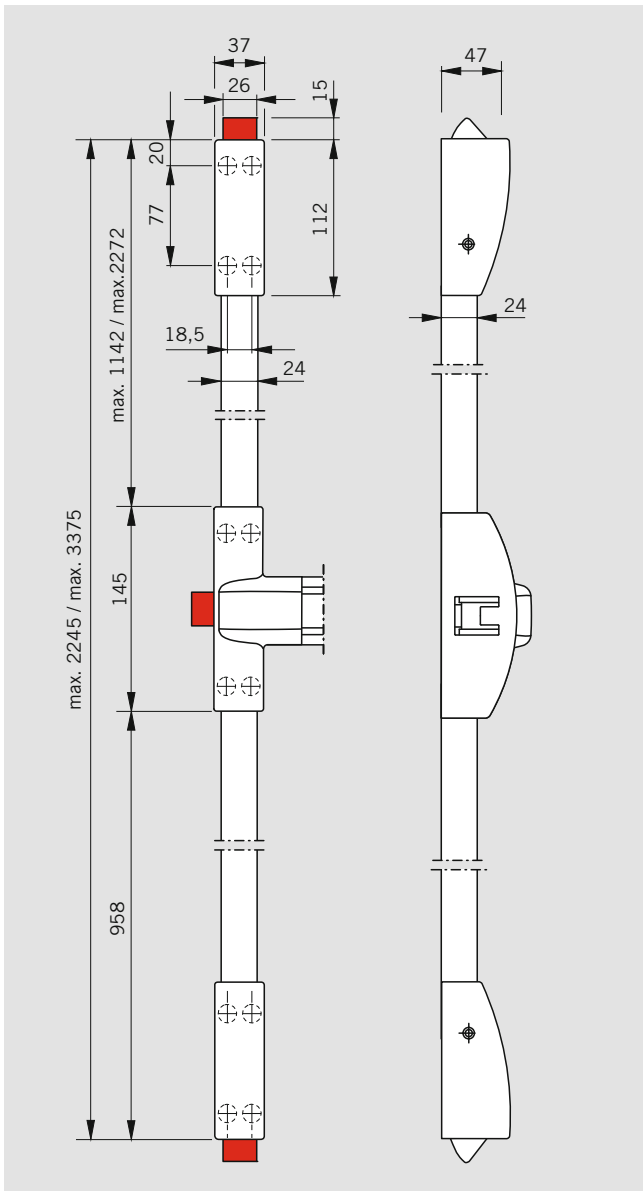



Applications and fixing details

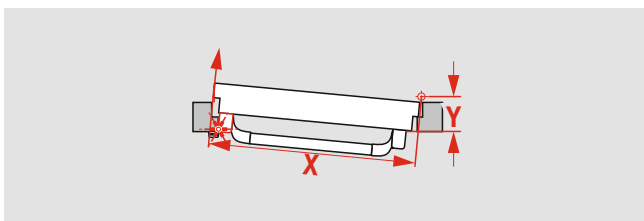
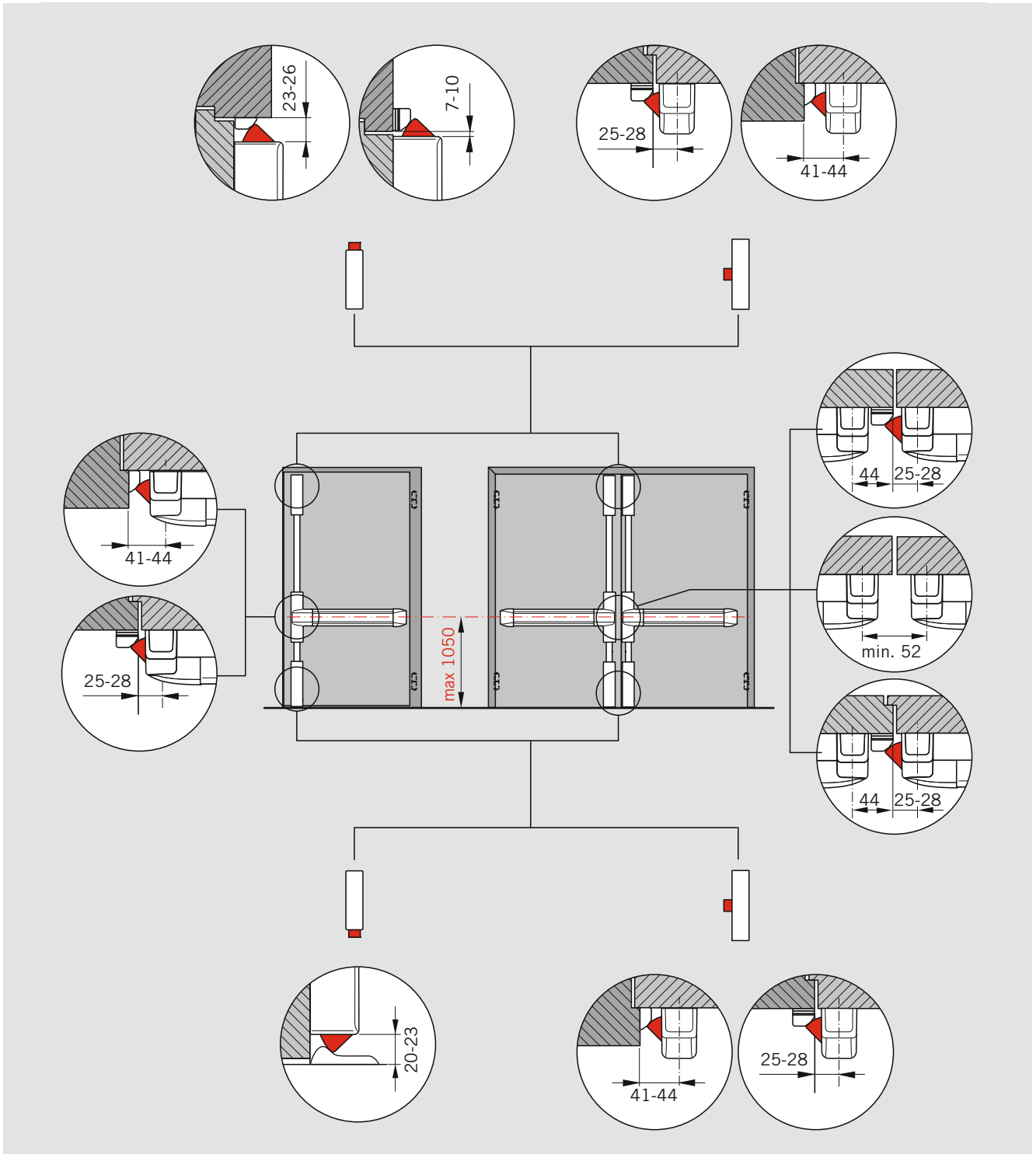

**Note**

It may be the case that the exit device cannot be installed based on standard measurements where the door situation is extreme, e.g. with a door width  $X < 1000$  mm combined

with a hinge offset  $Y > 90$  mm. DORMA will be glad to provide you with installation suggestions on request.

# PHA 2000 / PHB 3000

## Components on single-leaf doors

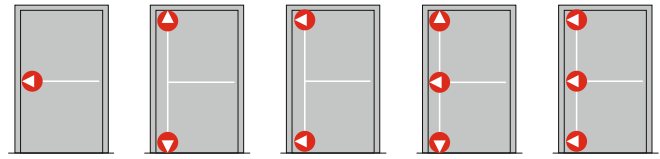

Standard doors	Modular		2101	●	●	●	●	●
	Standard		2201		○	○		
			2104/05	●	●	●	●	●
	Modular		3102/03	●	●	●	●	●
	Standard		3101	○				
			PHX 04/05		●	●	●	●
			PHX 02		●		●	
		PHX 06			●		●	
Fire and smoke check doors	Modular		2102	●	●	●	●	●
	Standard		2201		○	○		
			2104/05	●	●	●	●	●
	Modular		3104/05	●	●	●	●	●
			PHX 04/05		●	●	●	●
			PHX 03		●		●	
			PHX 07			●		●

○ optional

For external fittings, see page 34

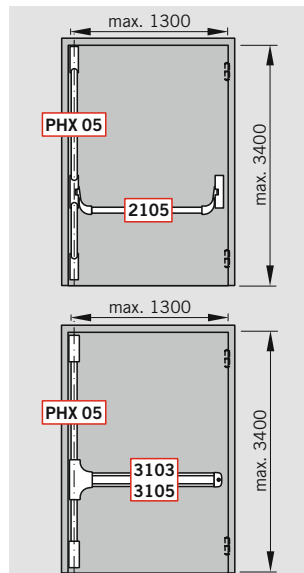
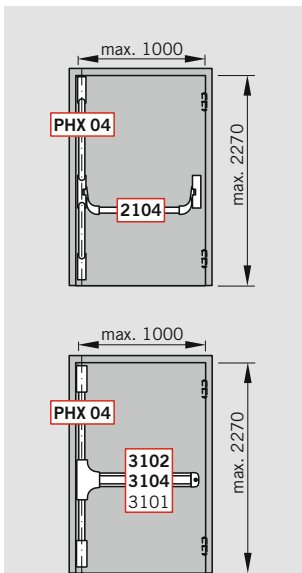

### F Approval certification

The panic hardware products of the series PHA 2000/ PHB 3000 in the Contur design marked with the **F** symbol have been approved for use on fire and smoke check doors. In some countries, approval certification of the fire and smoke check doors to be used is additionally required.

The panic hardware products of the series PHA 2000/ PHB 3000 in the Contur design carry the CE mark of conformity.

Components on double-leaf doors

Over-ribated door

Flush closing door

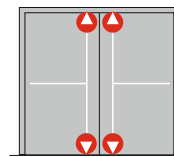
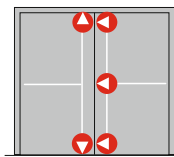
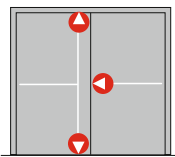

				Inactive leaf	Active leaf	Inactive leaf	Active leaf	Inactive leaf	Active leaf
Standard doors	Modular		2101	●	●	●	●	●	●
	Standard		2201	○		○		○	○
			2104/05	●	●	●	●	●	●
	Modular		3102/03	●	●	●	●	●	●
	Standard		3101		○				
			PHX 04/05	●		●	●	●	●
			PHX 02	●		●		●	●
		PHX 06				●			
Fire and smoke check doors	Modular		2102	●	●	●	●	●	●
	Standard		2201	○		○		○	○
			2104/05	●	●	●	●	●	●
	Modular		3104/05	●	●	●	●	●	●
			PHX 04/05	●		●	●	●	●
			PHX 03	●		●		●	●
			PHX 07				●		

○ optional

For external fittings, see page 34

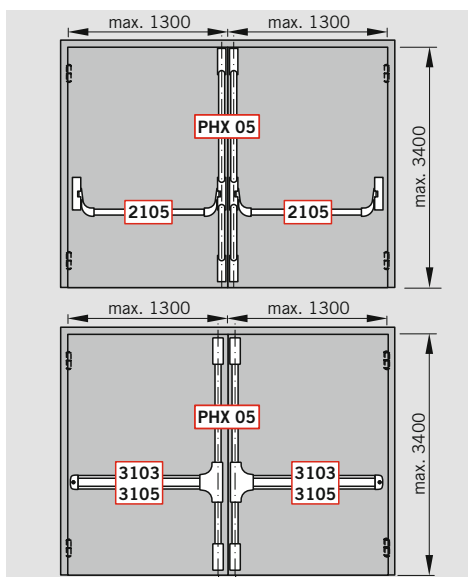
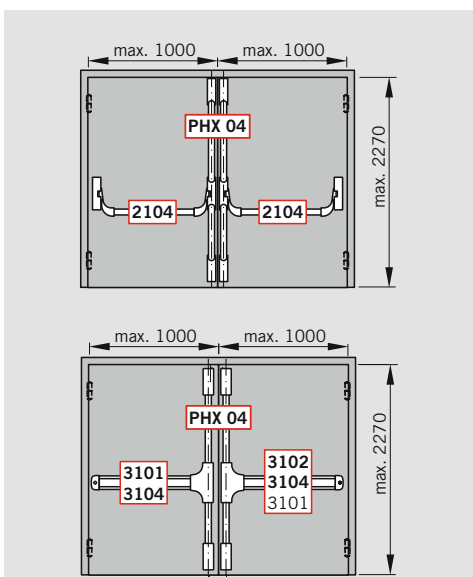

Note



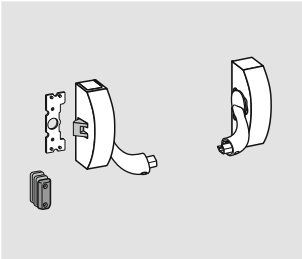
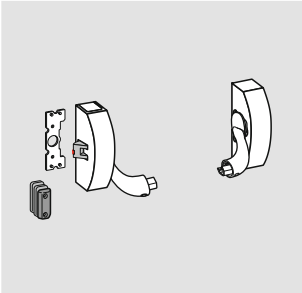
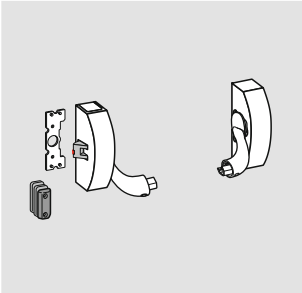
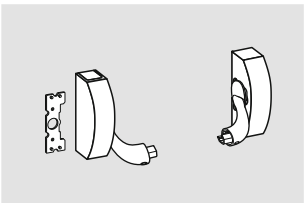
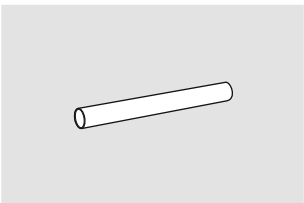
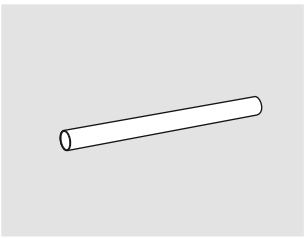

According to EN 1125, the effective length of the operating bar has to be at least 60% of the door width. Doors higher than 2500 mm lie outside the scope of EN 1125.

# PHA 2000

	Specification text	Order No.
	<p><b>PHA 2000</b>                      Panic exit device tested in accordance with EN 1125, for door widths up to 1300 mm, door heights up to 2270 (in accordance with EN 1125) or 3400 mm; non-handed. Can be unlocked electrically via electric strike. All products of the PHA 2000 series carry the CE mark.</p>	
	<p><b>PHA 2101</b>                      Single-point locking, modular, for standard doors, without security anti-thrust latch, with dogging device. Zinc die-cast latch, zinc latch keeper with spacer plates, plastic mounting backplate.</p> <p><input type="checkbox"/> silver finish  <input type="checkbox"/> black  <input type="checkbox"/> white</p>	<p>35014 21011001                      35014 21011002                      35014 21011010</p>
	<p><b>PHA 2102</b> <span style="color: red;">F</span>                      Single-point locking, modular, for fire and smoke check doors, with security anti-thrust latch and dogging device. Steel latch, steel latch keeper with spacer plates, plastic mounting backplate.</p> <p><input type="checkbox"/> silver finish  <input type="checkbox"/> black  <input type="checkbox"/> white  <input type="checkbox"/> stainless steel finish</p>	<p>35014 21021001                      35014 21021002                      35014 21021010                      35014 21021004</p>
	<p><b>PHA 2201</b>                      Two-point locking only, with dogging device. Plastic mounting backplate.</p> <p><input type="checkbox"/> silver finish  <input type="checkbox"/> black  <input type="checkbox"/> white</p>	<p>35014 22011001                      35014 22011002                      35014 22011010</p>
	<p><b>PHA 2104</b>                      Connecting rod 830 mm (for door widths up to 1000 mm)</p> <p><input type="checkbox"/> silver finish  <input type="checkbox"/> red  <input type="checkbox"/> black  <input type="checkbox"/> white</p>	<p>35014 21040001                      35014 21040002                      35014 21040019                      35014 21040010</p>
	<p><b>PHA 2105</b>                      Connecting rod 1130 mm (for door widths up to 1300 mm)</p> <p><input type="checkbox"/> silver finish  <input type="checkbox"/> red  <input type="checkbox"/> black  <input type="checkbox"/> white  <input type="checkbox"/> stainless steel finish</p>	<p>35014 21050001                      35014 21050002                      35014 21050019                      35014 21050010                      35014 21050004</p>

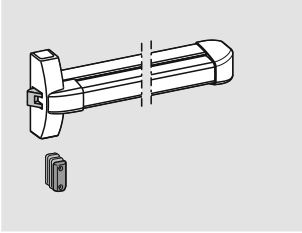
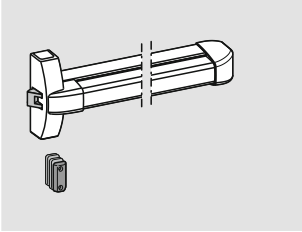
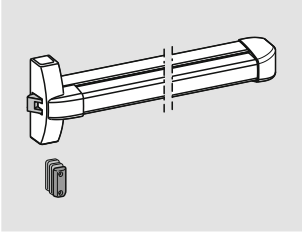
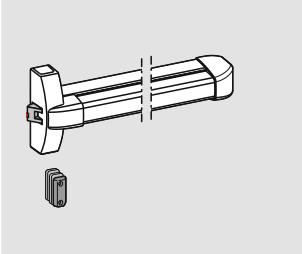
See page 30 for accessories such as adjustable keepers, electric strikes or micro switches for signal actuation.

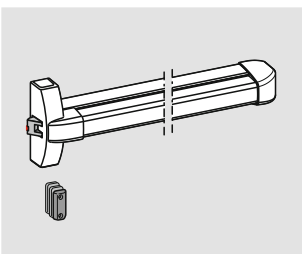
# PHB 3000

	Specification text	Order No.
	<p><b>PHA 3000</b>                      Panic exit device tested in accordance with EN 1125, for door widths up to 1300 mm, door heights up to 2270 mm (in accordance with EN 1125) or 3400 mm, non-handed. Can be unlocked electrically via electric strike. All products of the PHB 3000 series carry the CE mark.</p>	
	<p><b>PHB 3101</b>                      Single-point locking, standard, for standard doors with a door width up to 1000 mm, without security anti-thrust latch, with dogging device. Zinc die-cast latch, steel latch keeper with spacer plates.</p> <p><input type="checkbox"/> silver finish  <input type="checkbox"/> white</p>	<p>35014 31011001                      35014 31011010</p>
	<p><b>PHB 3102</b>                      Single-point locking, modular, for standard doors with a door width up to 1000 mm, without security anti-thrust latch, with dogging device. Zinc die-cast latch, steel latch keeper with spacer plates.</p> <p><input type="checkbox"/> silver finish  <input type="checkbox"/> white</p>	<p>35014 31021001                      35014 31021010</p>
	<p><b>PHB 3103</b>                      Single-point locking, modular, for standard doors with a door width up to 1300 mm, without security anti-thrust latch, with dogging device. Zinc die-cast latch, steel latch keeper with spacer plates.</p> <p><input type="checkbox"/> silver finish  <input type="checkbox"/> white</p>	<p>35014 31031001                      35014 31031010</p>
	<p><b>PHA 3104</b>                       Single-point locking, modular, for fire and smoke check doors with a door width up to 1000 mm, with security anti-thrust latch and dogging device. Steel latch, steel latch keeper with spacer plates.</p> <p><input type="checkbox"/> silver finish  <input type="checkbox"/> white  <input type="checkbox"/> stainless steel finish</p>	<p>35014 31041001                      35014 31041010                      35014 31041004</p>
	<p><b>PHA 3105</b>                       Single-point locking, modular, for fire and smoke check doors with a door width up to 1300 mm, with security anti-thrust latch and dogging device. Steel latch, steel latch keeper with spacer plates.</p> <p><input type="checkbox"/> silver finish  <input type="checkbox"/> white  <input type="checkbox"/> stainless steel finish</p>	<p>35014 31051001                      35014 31051010                      35014 31051004</p>

# PHA 2000 / PHB 3000

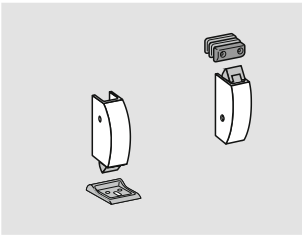
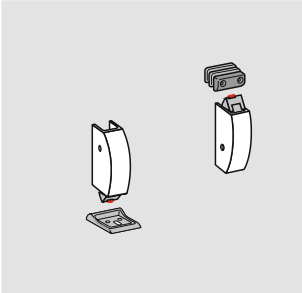
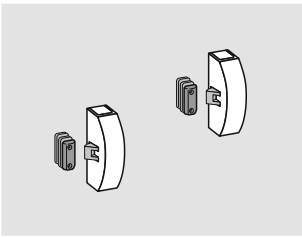
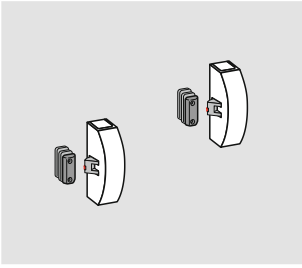
	Specification text	Order No.
	<p><b>PHX 02</b>                      Top and bottom lock combination, without security anti-thrust latch.                      Zinc die-cast latch, zinc top latch keeper with spacer plates,                      steel bottom latch keeper.</p>	
	<p><input type="checkbox"/> silver finish  <input type="checkbox"/> black  <input type="checkbox"/> white</p>	<p>35014 22021001                      35014 22021002                      35014 22021010</p>
	<p><b>PHX 03 F</b>                      Top and bottom lock combination,                      for fire and smoke check doors, with security anti-thrust latch.                      Steel latch, steel top latch keeper with spacer plates,                      steel bottom latch keeper.</p>	
	<p><input type="checkbox"/> silver finish  <input type="checkbox"/> black  <input type="checkbox"/> white  <input type="checkbox"/> stainless steel finish</p>	<p>35014 22031001                      35014 22031002                      35014 22031010                      35014 22031004</p>
	<p><b>PHX 06</b>                      Top and bottom locking combination with lateral latch,                      without security anti-thrust latch.                      Die-cast zinc latch, steel latch keepers with spacer plates.</p>	
	<p><input type="checkbox"/> silver finish  <input type="checkbox"/> black  <input type="checkbox"/> white</p>	<p>35014 22061001                      35014 22061002                      35014 22061010</p>
	<p><b>PHX 07 F</b>                      Top and bottom locking combination with lateral latch,                      for fire and smoke check doors, with security anti-thrust latch.                      Steel latch, steel latch keepers with spacer plates.</p>	
	<p><input type="checkbox"/> silver finish  <input type="checkbox"/> black  <input type="checkbox"/> white  <input type="checkbox"/> stainless steel finish</p>	<p>35014 22071001                      35014 22071002                      35014 22071010                      35014 22071004</p>

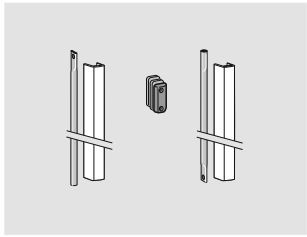
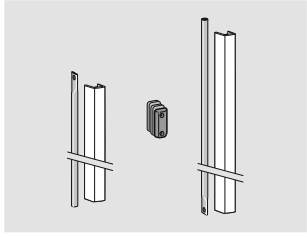
	Specification text	Order No.
	<p><b>PHX 04</b> <span style="color: red;">F</span></p> <p>Connecting rod set with cover for door heights up to 2270 mm. Steel latch keeper with spacer plates for double doors.</p> <p><input type="checkbox"/> silver finish  <input type="checkbox"/> black  <input type="checkbox"/> white  <input type="checkbox"/> stainless steel finish</p>	<p>35014 22041001  35014 22041002  35014 22041010  35014 22041004</p>
	<p><b>PHX 05</b> <span style="color: red;">F</span></p> <p>Connecting rod set with cover for door heights up to 3400 mm. Steel latch keeper with spacer plates for double doors.</p> <p><input type="checkbox"/> silver finish  <input type="checkbox"/> black  <input type="checkbox"/> white  <input type="checkbox"/> stainless steel finish</p>	<p>35014 22051001  35014 22051002  35014 22051010  35014 22051004</p>

# EXIT PAD

## EMERGENCY EXITS PROTECTED IN ACCORDANCE WITH EN 179

The fittings of the Exit Pad series are high-quality emergency exit devices for doors in escape routes and can be combined with the components of the PHA 2000/PHB 3000 series. They are used in buildings with no public pedestrian traffic. It is expected that people using the building are familiar with the exits and their fittings, avoiding the likelihood of a panic situation developing.

All products of the Exit Pad series have been tested to and certified compliant with EN 179. They correspond to the requirements of Annex ZA to EN 179 and can therefore carry the CE mark of conformity.

### Benefits

#### For the trade

- All-in-one packaging for easy stocking
- Non-handed
- Universal use of PHT external fittings

#### For the installer

- Straightforward fixing
- Easy adjustment to different door widths and heights

#### For the architect/specifier

- High-quality appearance with no visible fixings
- Connecting rods with metal covers
- External fitting with DORMA lever handle or knob

#### For the user

- Simple operation
- Excellent quality ensures long lifespan

Data and features	Exit Pad <sup>1)</sup>	
	1-point	2-point
Standard doors (single-leaf/double-leaf)	●	●
Fire and smoke check doors (single-leaf/double-leaf) <b>F</b>	●	●
Glass doors	●	●
Door width	≤ 1300 mm	–
Door height	≤ 2270 mm	●
Max. door leaf weight (in kg)	200	200
Non-handed	●	●
Security anti-thrust latch	for standard doors	–
	for fire and smoke check doors	●
Unlocking via electric strike	○	○
External fittings PHT		
For standard doors and fire and smoke check doors	●	●
For door leaf thicknesses up to 60 mm		
Extended handle spindle and bolts for door leaf thicknesses of 60 – 105 mm	○	○
Approved to EN 179	●	●
CE mark for construction products	●	●

● Yes – No ○ Option

<sup>1)</sup> To achieve a three-point locking system, the Exit Pad can be used as a modular single-point locking device in combination with the PHX components from the PHA 2000/PHB 3000 series. In conjunction with PHX 05 door height max. 3400 mm (Doors higher than 2500 mm lie outside the scope of EN 179).



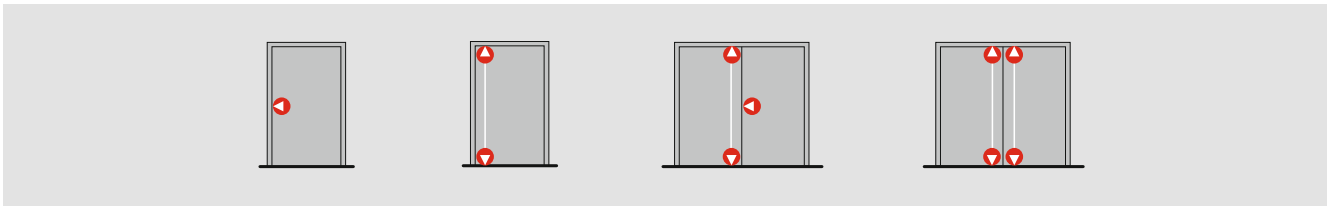



**Exit Pad**

Single-point locking

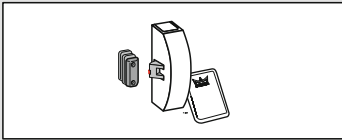



Two-point locking



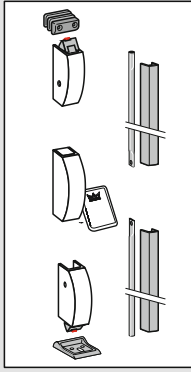



+  
PHT

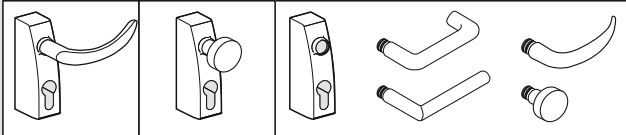

**Security anti-thrust latch**

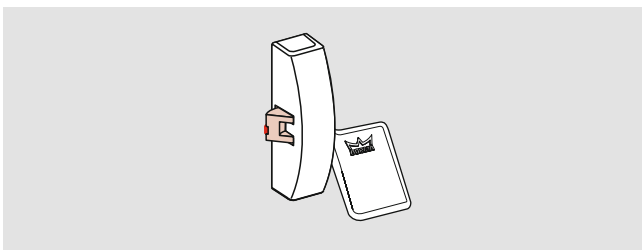

The security anti-thrust latch prevents the latch from being pushed back by unauthorised means when it is in the closed position.

# EXIT PAD

## Single-point locking

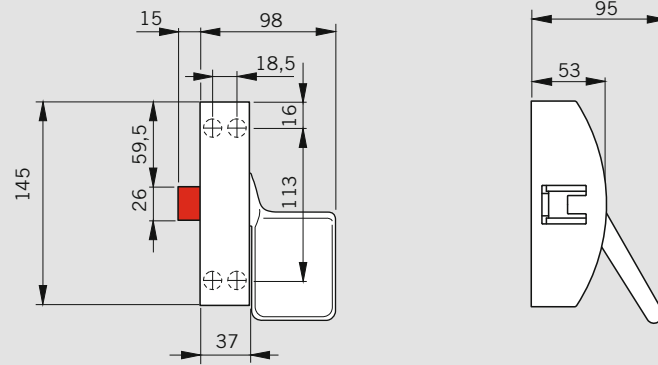

## Two-point locking

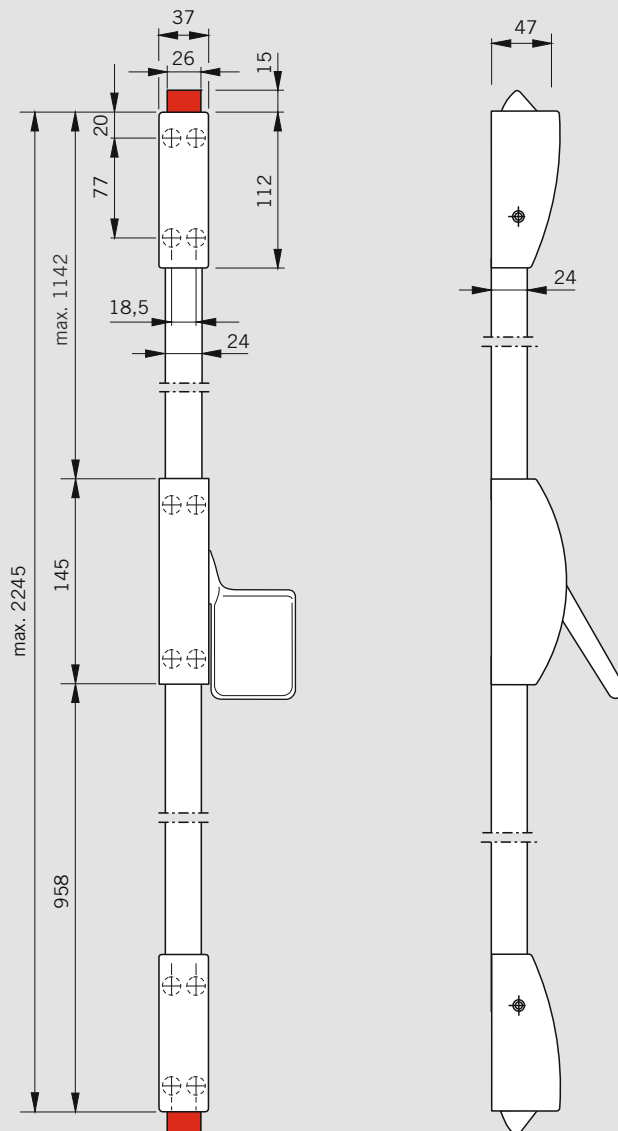

Applications and fixing details

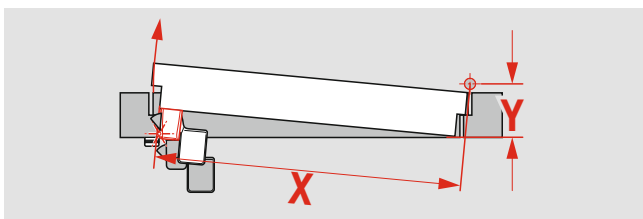
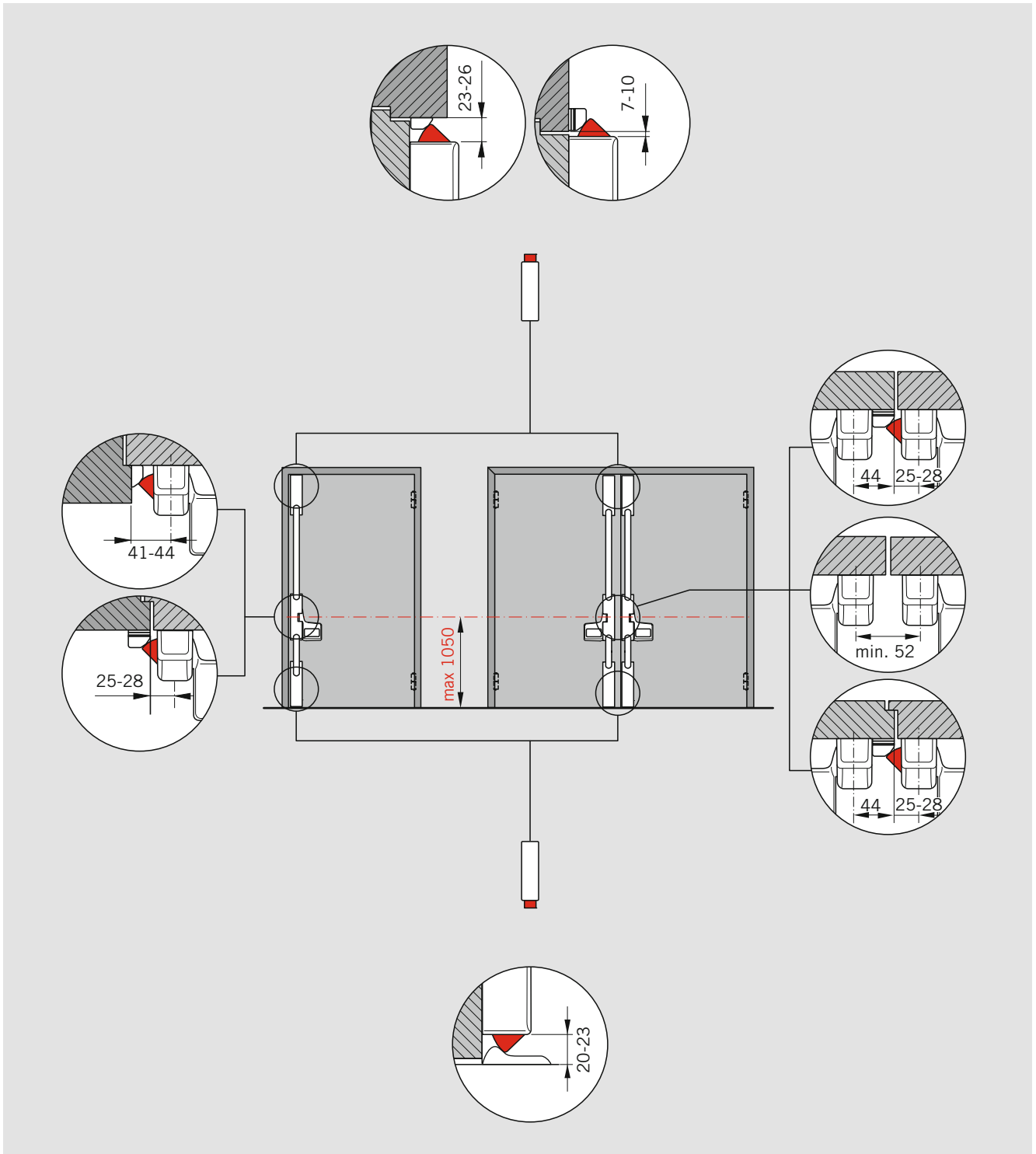

**Note**

It may be the case that the exit device cannot be installed based on standard measurements where the door situation is extreme, e.g. with a door width  $X < 1000$  mm combined

with a hinge offset  $Y > 90$  mm. DORMA will be glad to provide you with installation suggestions on request.

# EXIT PAD

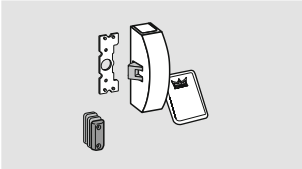
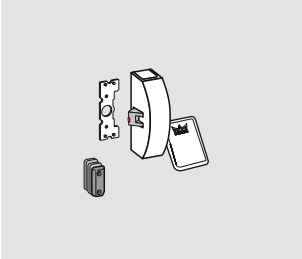
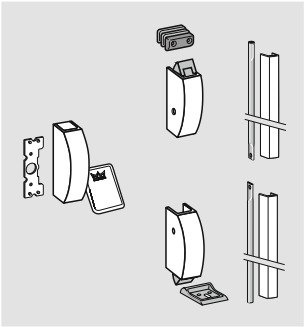
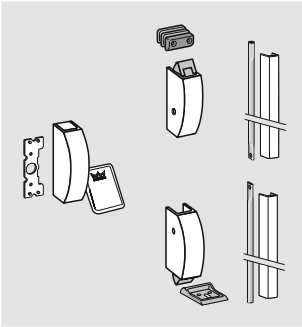
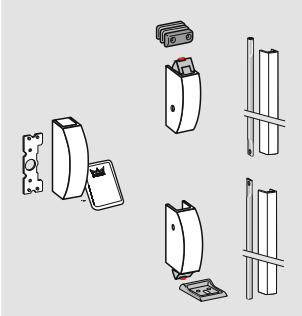
	Specification text	Order No.
	<p><b>Exit Pad</b> Emergency exit device tested and approved to EN 179, non-handed. Can be unlocked electrically via electric strike. All products of the Exit Pad series carry the CE mark of conformity.</p>	
	<p><b>Exit Pad F</b> Single-point locking, modular, for all standard doors, without security anti-thrust latch. Zinc die-cast latch, zinc latch keeper, with spacer plates, plastic mounting bracket.</p>	
	<p><b>Exit Pad 2P</b> Single-point locking, modular, for fire and smoke check doors, with security anti-thrust latch. Steel latch, steel latch keeper with spacer plates, plastic mounting bracket.</p>	
	<p><b>Exit Pad F 2P</b> Two-point locking for standard doors, door heights up to 2270 mm, without security anti-thrust latch. Zinc die-cast latch, zinc latch keeper with spacer plates, plastic mounting bracket.</p>	
	<p><b>Exit Pad F 2P</b> Two-point locking, for fire and smoke check doors, door heights up to 2270 mm, with security anti-thrust latch. Steel latch, steel latch keeper with spacer plates, plastic mounting backplate.</p>	

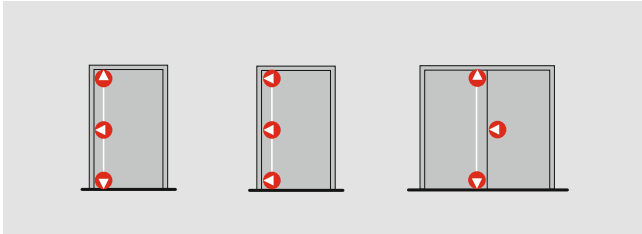

**Note**

To achieve three-point locking, the modular single-point locking Exit Pad can be used in conjunction with the components of the PHA 2000/ PHB 3000 series.

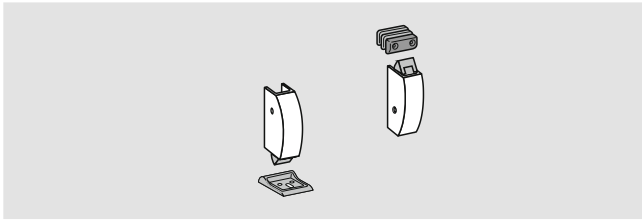

**PHX 02**

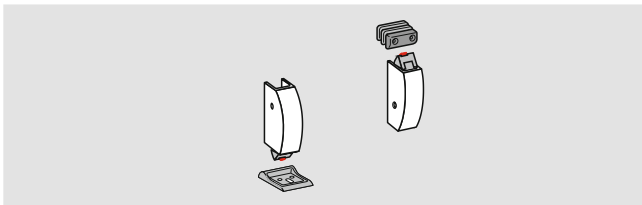

**PHX 03**

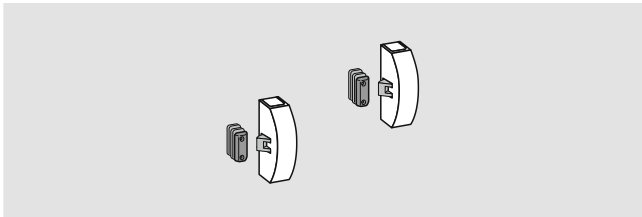

**PHX 06**

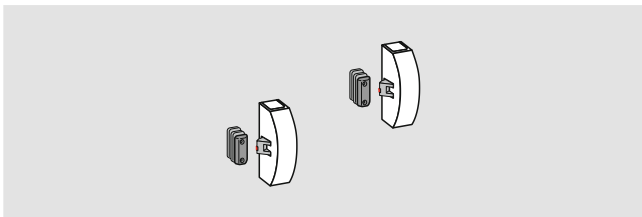

**PHX 07**

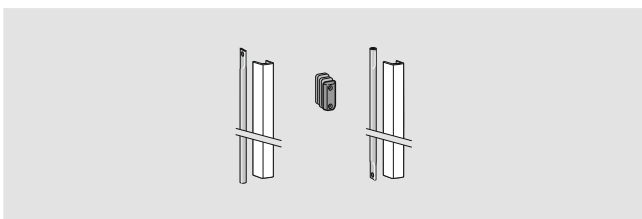

**PHX 04**

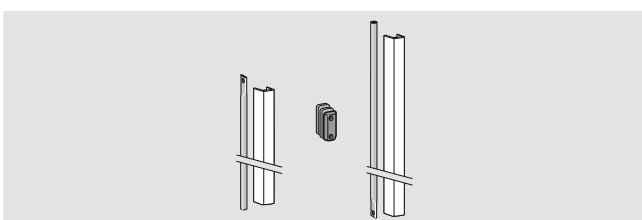

**PHX 05**

# GLASS KIT

DORMA's PHA 2000 and Exit Pad devices can be fitted to a wide range of toughened glass doors.

- For doors in all glass or framed assemblies.
- For single and double doors.
- Single or multi-point Locking.
- Suitable for combination with external glass door mini-fittings.
- For 8 to 10 mm toughened safety glass (single panel).
- Maximum leaf width: 1,300 mm.
- Maximum leaf height: 2,500 mm.
- Standard stainless steel design.

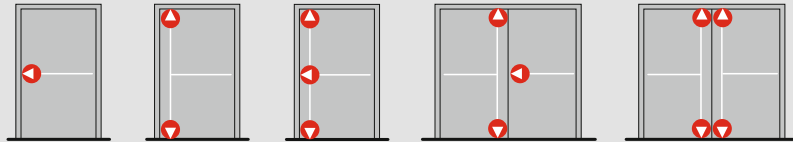

**PHA 2000**  
single-point locking

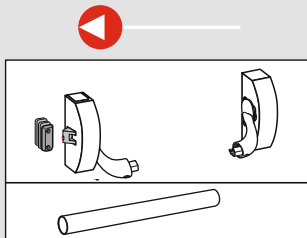

**Exit Pad**  
single-point locking

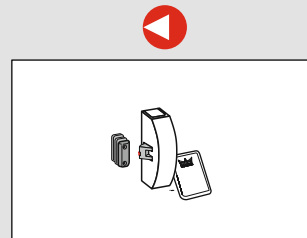

without external fitting	<p><b>Glass Kit A</b></p>
PHT Mini	<p><b>Glass Kit B (DIN-L)</b> <b>Glass Kit C (DIN-R)</b></p>

2/3-point locking

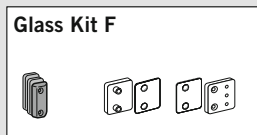
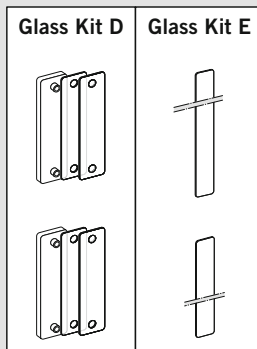
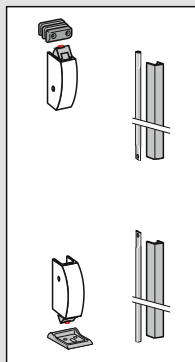

2-point locking

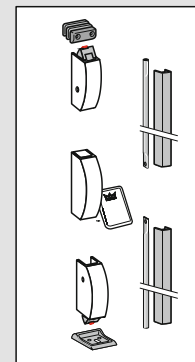

PHA 2000 on glass doors

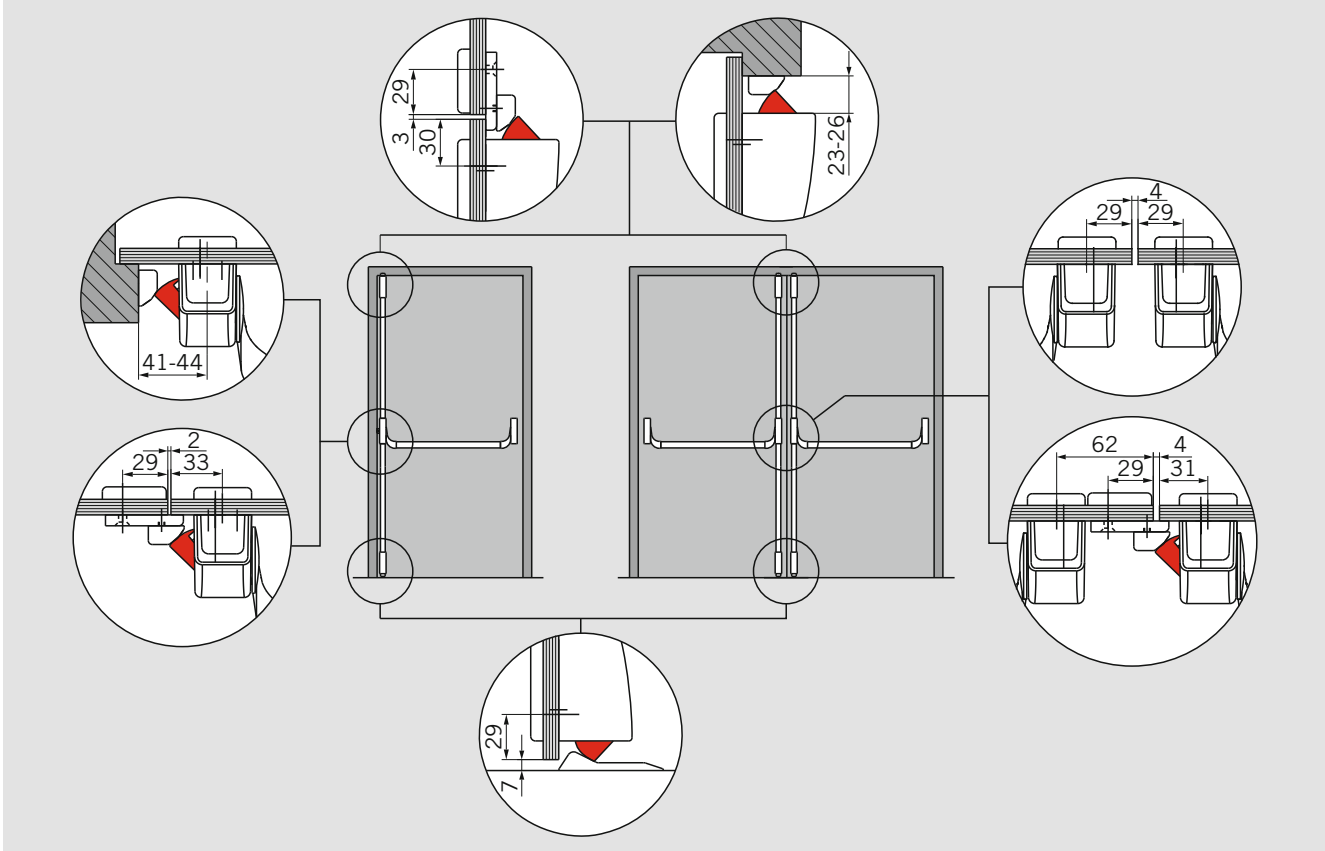

Exit Pad on glass doors

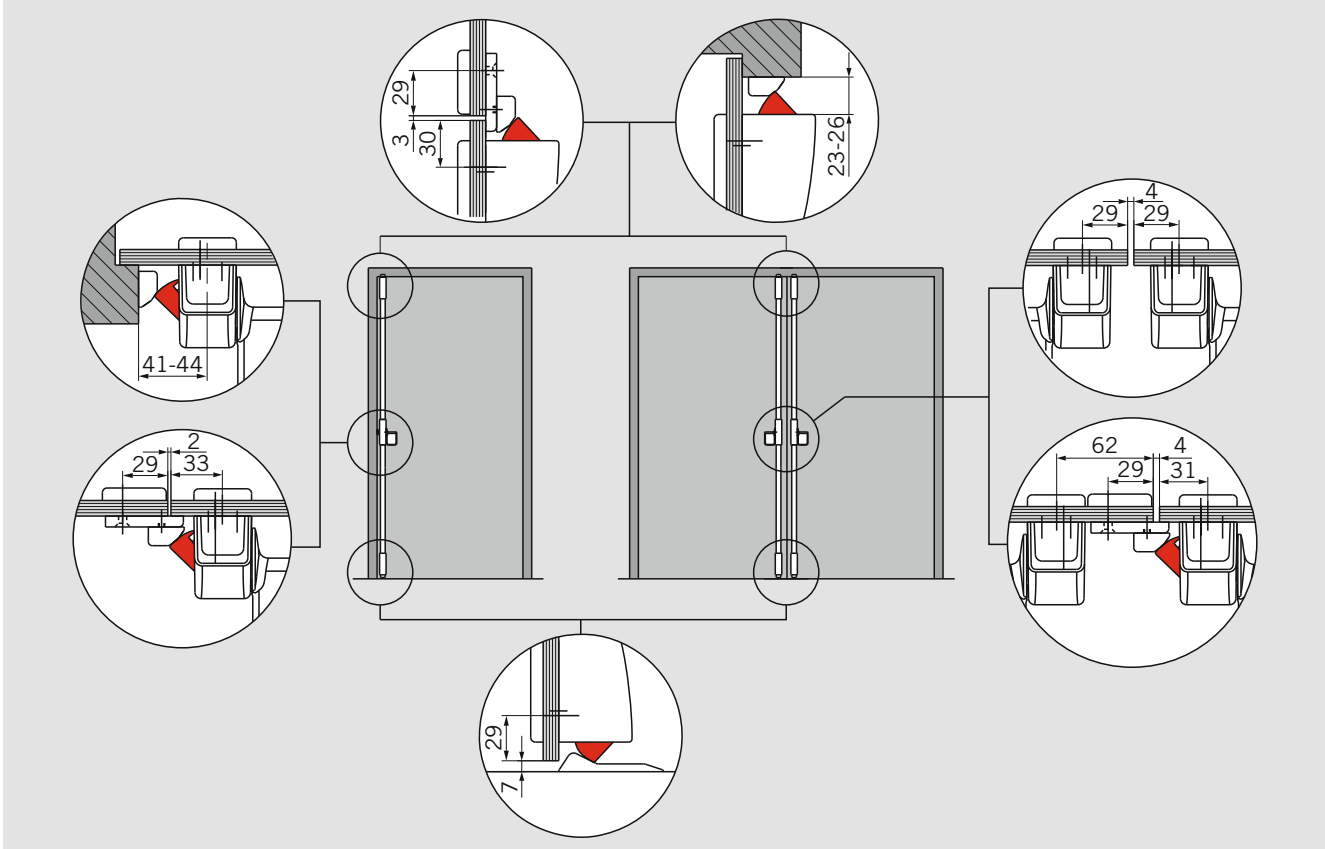

# GLASS KIT

PHA 2000 / Exit Pad on single leaf all glass doors

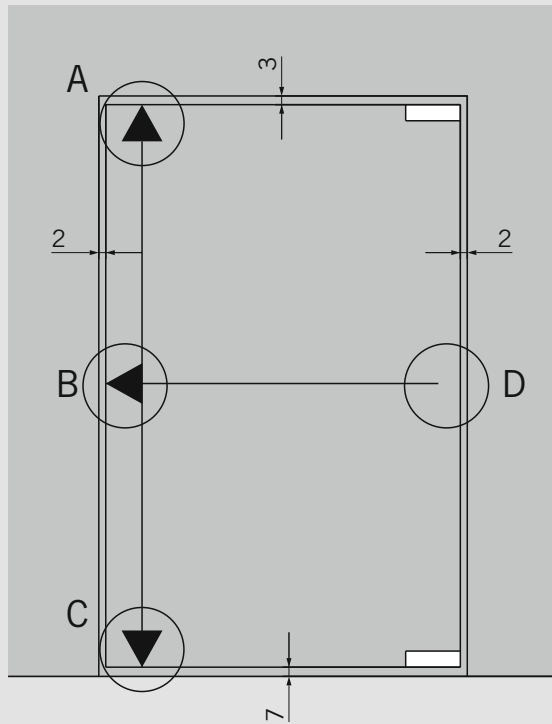
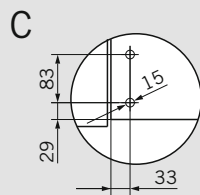
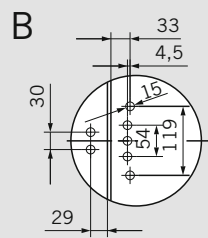
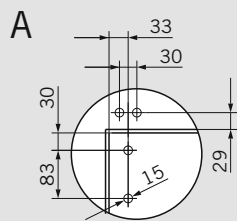

**D** only PHA 2000

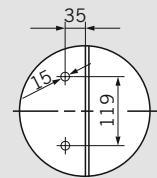



PHA 2000 / Exit Pad on double leaf all glass doors

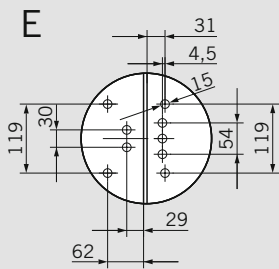
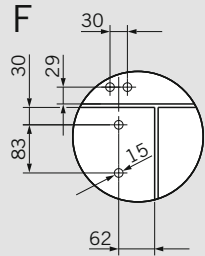

D only PHA 2000

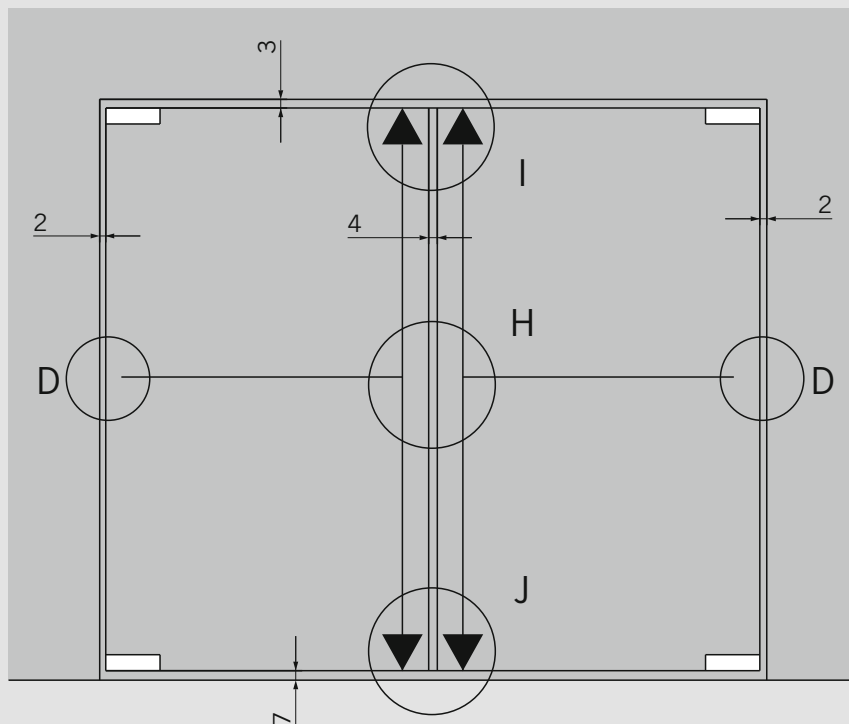
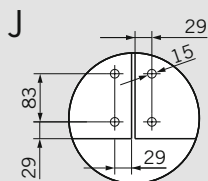
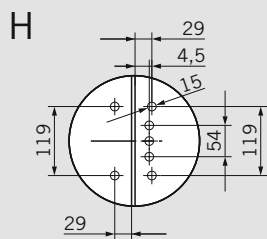
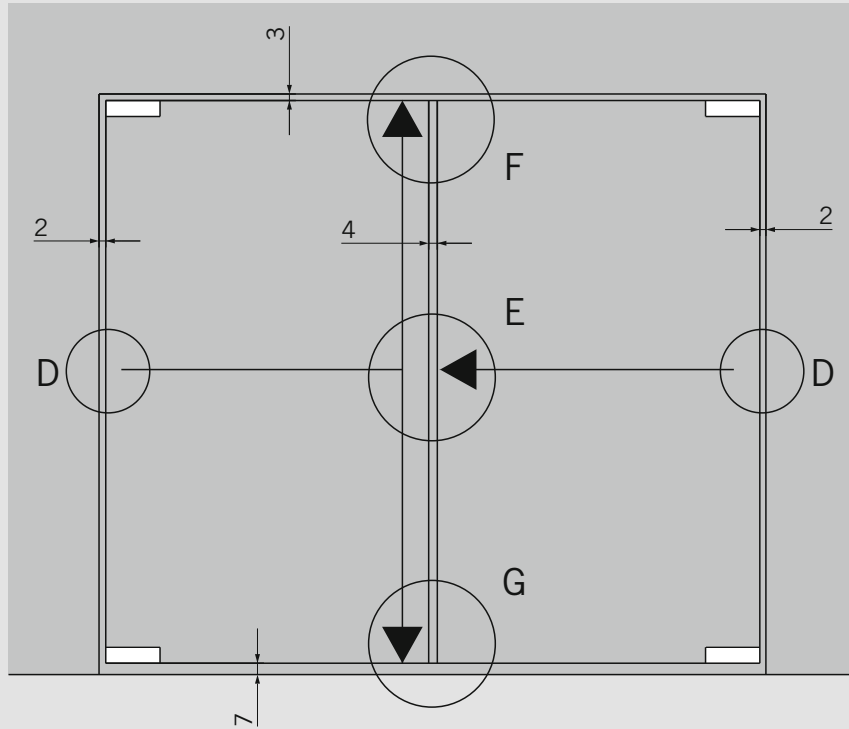
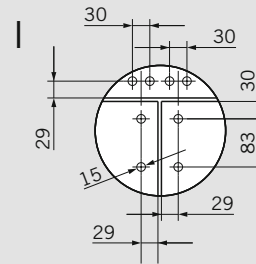
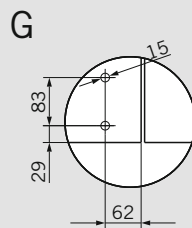
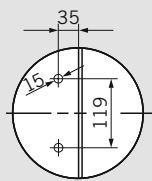

# GLASS KIT

PHA 2000 / Exit Pad on single leaf glass doors with frame

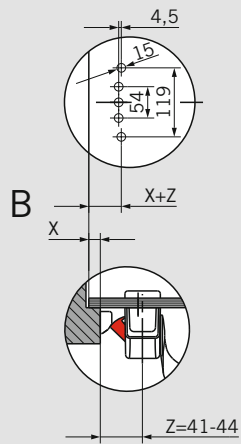
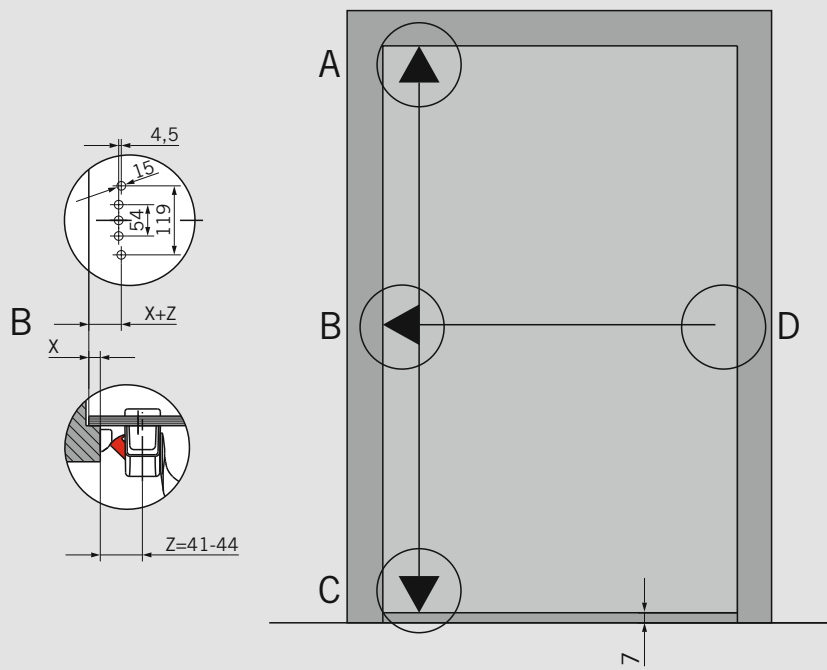
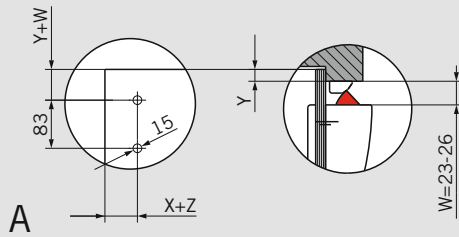

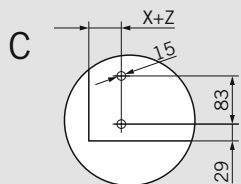
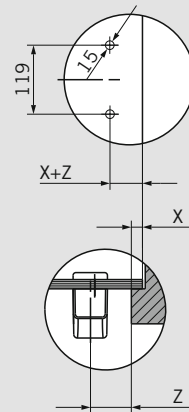

D only PHA 2000

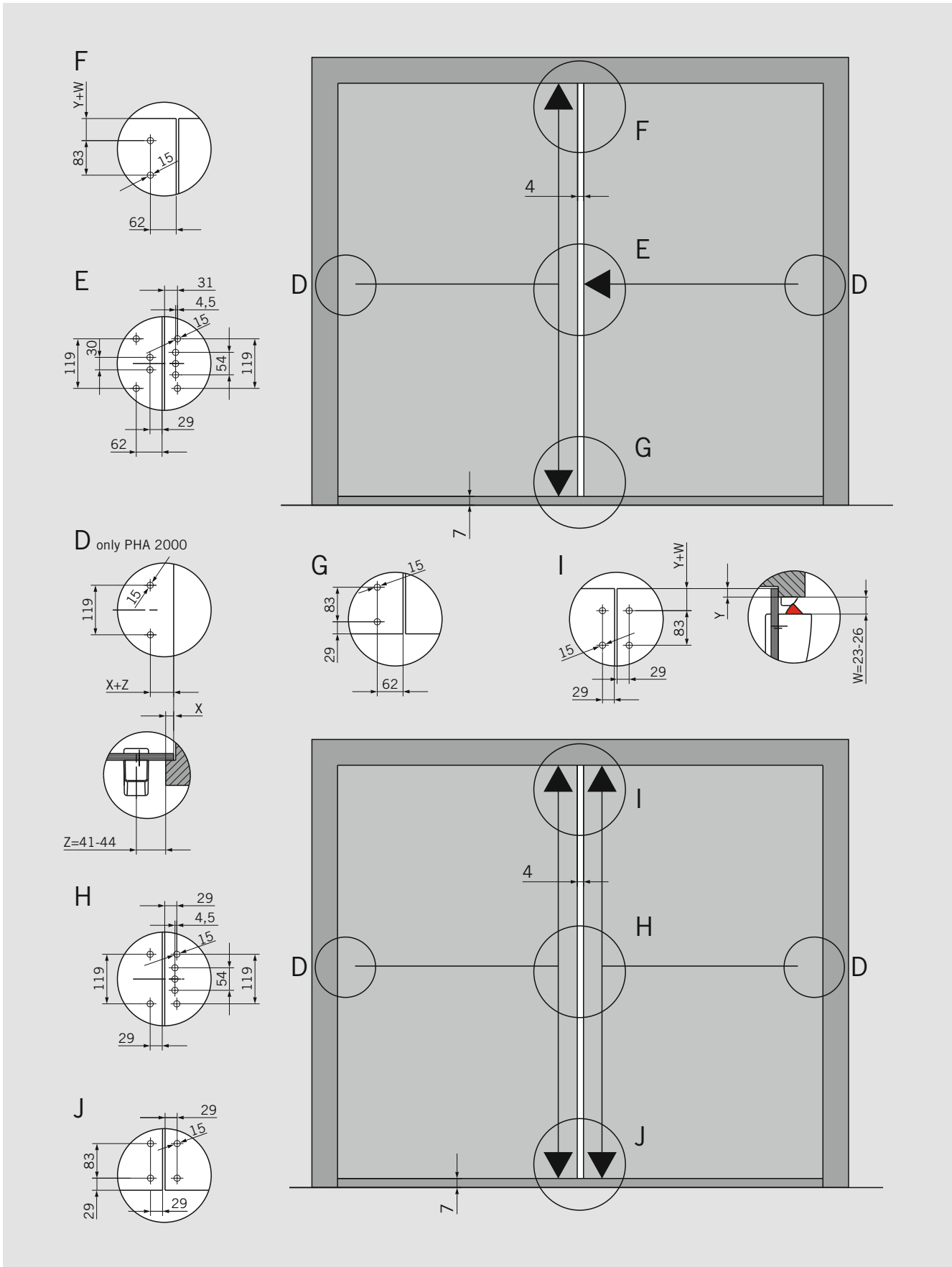

PHA 2000 / Exit Pad on double leaf glass doors with frame

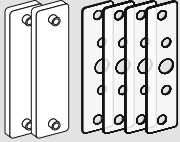
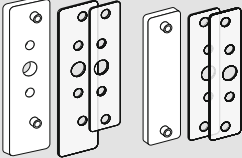
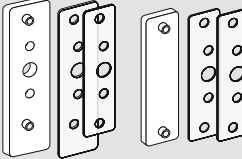
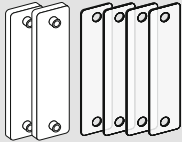
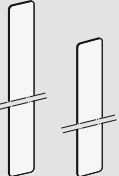
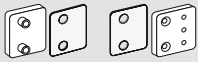

# GLASS KIT

	Specification text	Order No.
	<p><b>PHA Glass Kit A</b> Installation set for PHA 2000, Single-point locking, without external fitting. Stainless steel finish</p>	35014 24011004
	<p><b>PHA Glass Kit B</b> Installation set for LH (ISO 6), for PHA 2000, Single-point locking, without external fitting. Stainless steel finish</p>	35014 24021004
	<p><b>PHA Glass Kit C</b> Installation set for RH (ISO 5), for PHA 2000, Single-point locking, without external fitting. Stainless steel finish</p>	35014 24031004
	<p><b>PHA Glass Kit D</b> Installation set for PHA 2000, Top and bottom locking, vertical. Stainless steel finish</p>	35014 24041004
	<p><b>PHA Glass Kit E</b> Covering profiles for top and bottom connecting rod. Stainless steel finish</p>	35014 24051004
	<p><b>PHA Glass Kit F</b> Mounting plate for steel latch keepers, for single and double-leaf doors. Stainless steel finish</p>	35014 24061004
	<p><b>PHA Glass Kit Mini</b> External fitting Stainless steel finish</p>	35014 24071004



# ACCESSORIES

## PHX 50 – Electric Strike

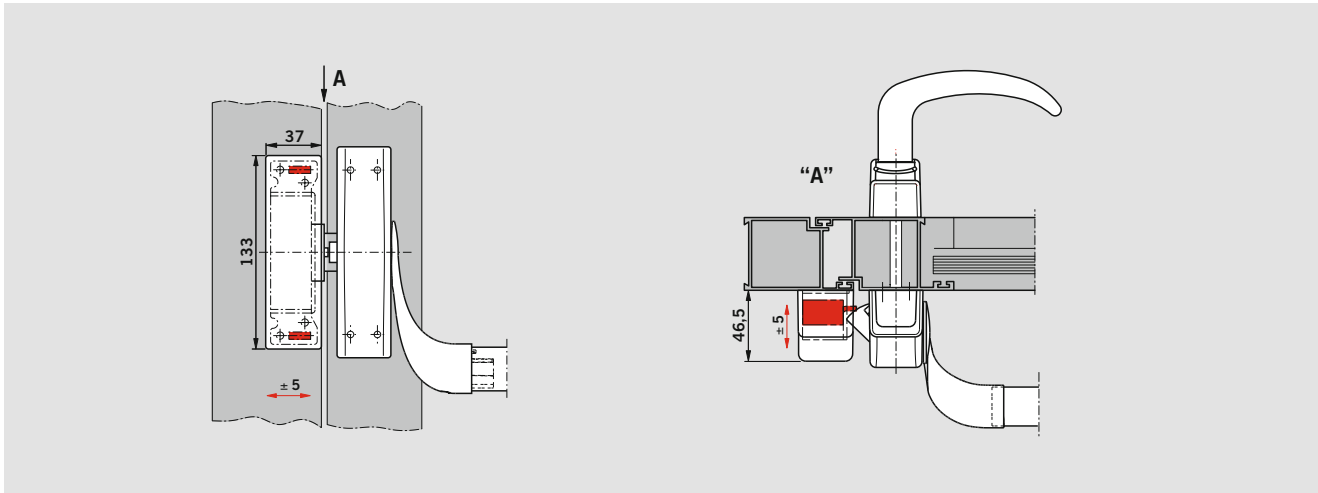

Application example for PHX 50 with PHA 2000 in the Contur design on an aluminium framed door

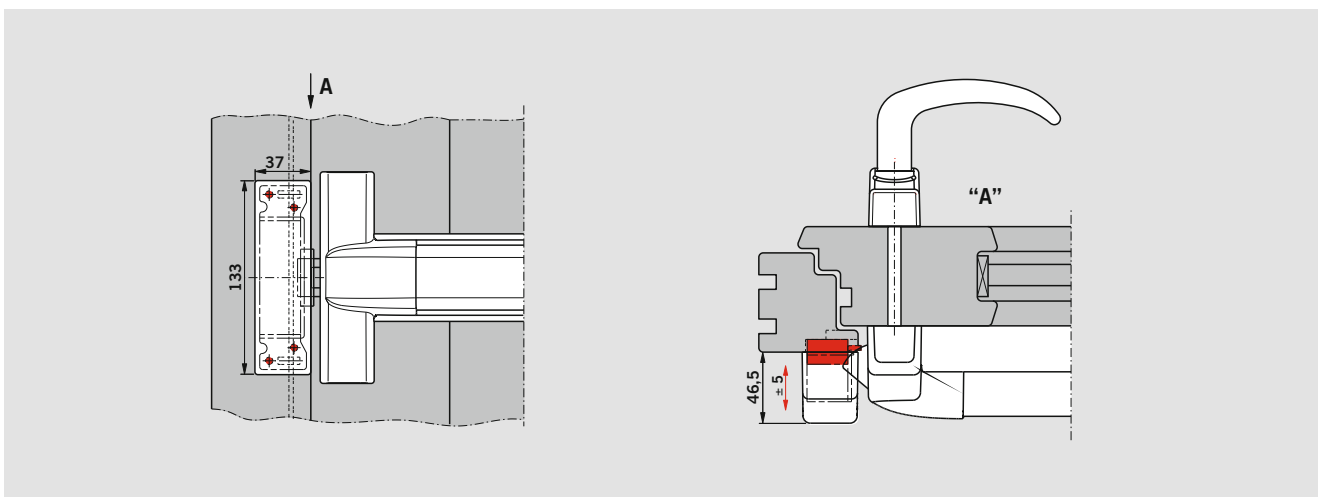

Application example for PHX 50 with PHB 3000 in the Contur design on an aluminium framed door

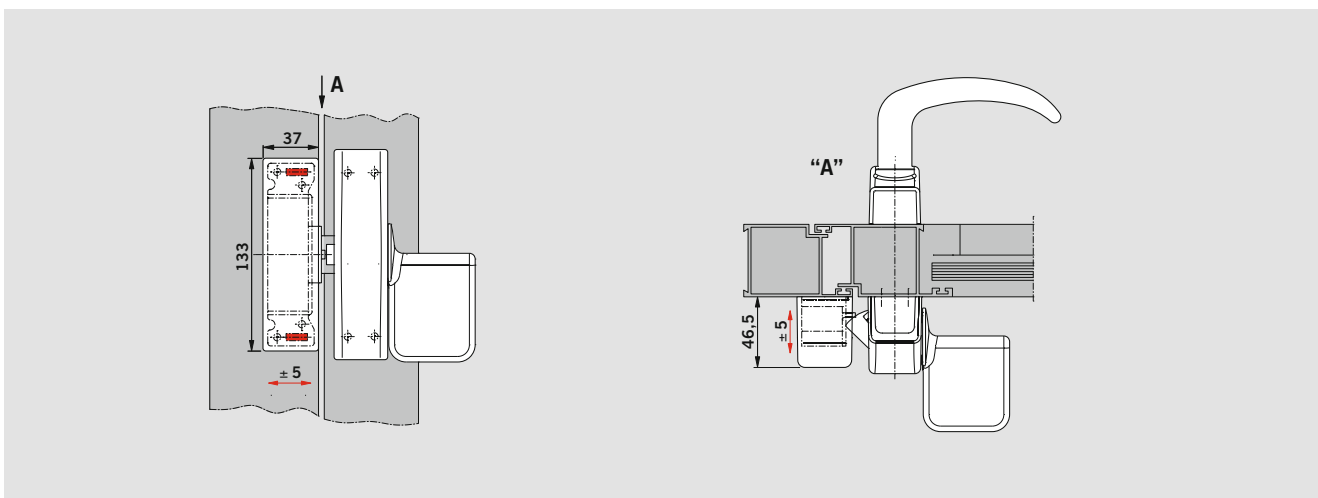

Application example for PHX 50 with Exit Pad in the Contur design on an aluminium framed door

**PHX 21 – Adjustable Latch Keeper for Aluminium Narrow-Stile Doors**

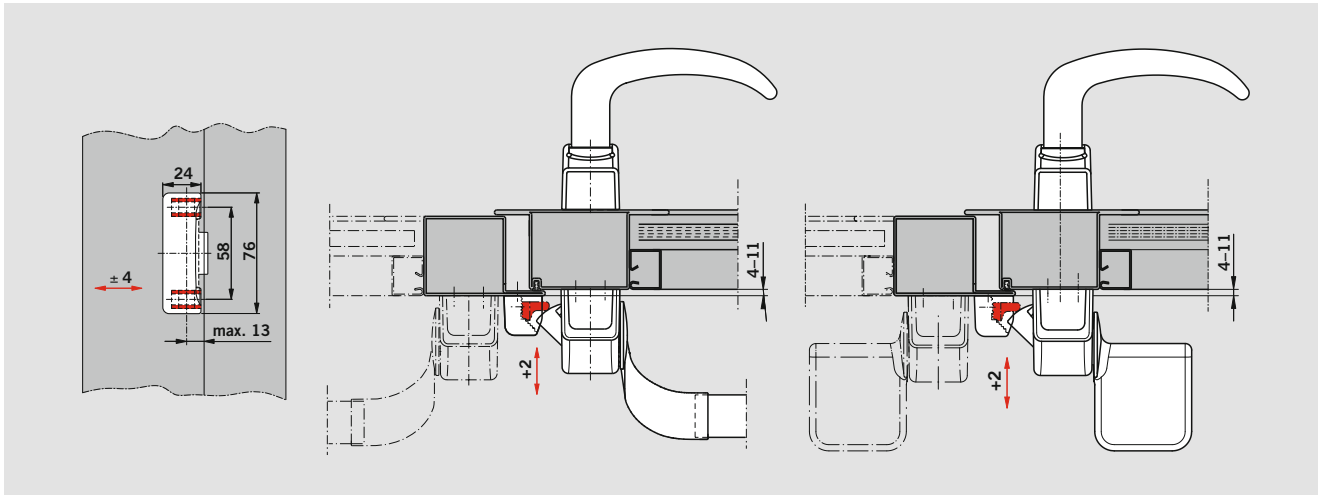

Application example of a PHX 21 on an over-rebated door, universal applicability for single-leaf and double-leaf doors

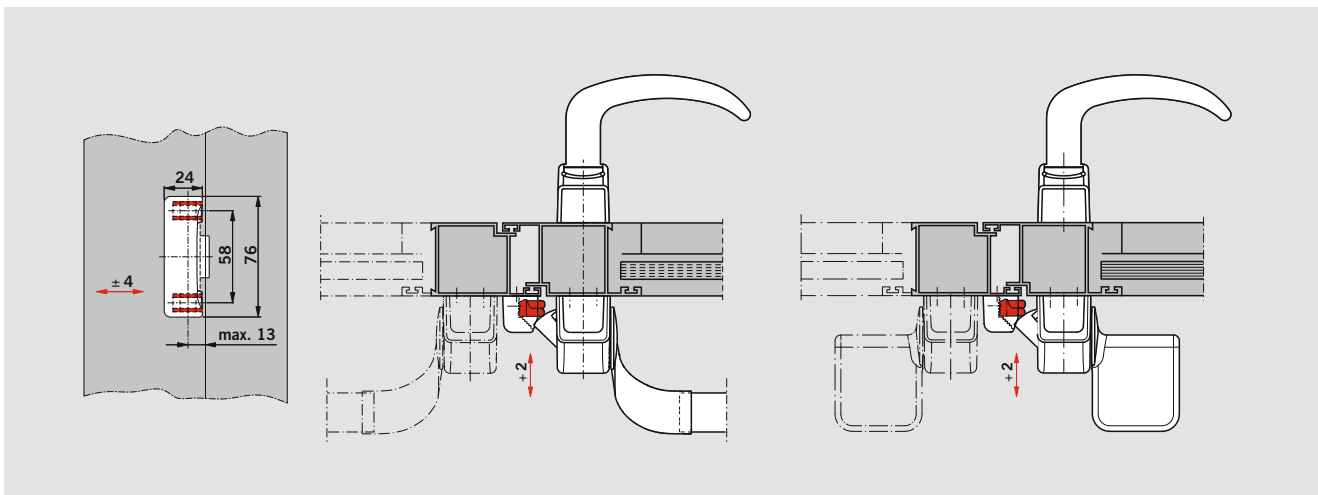



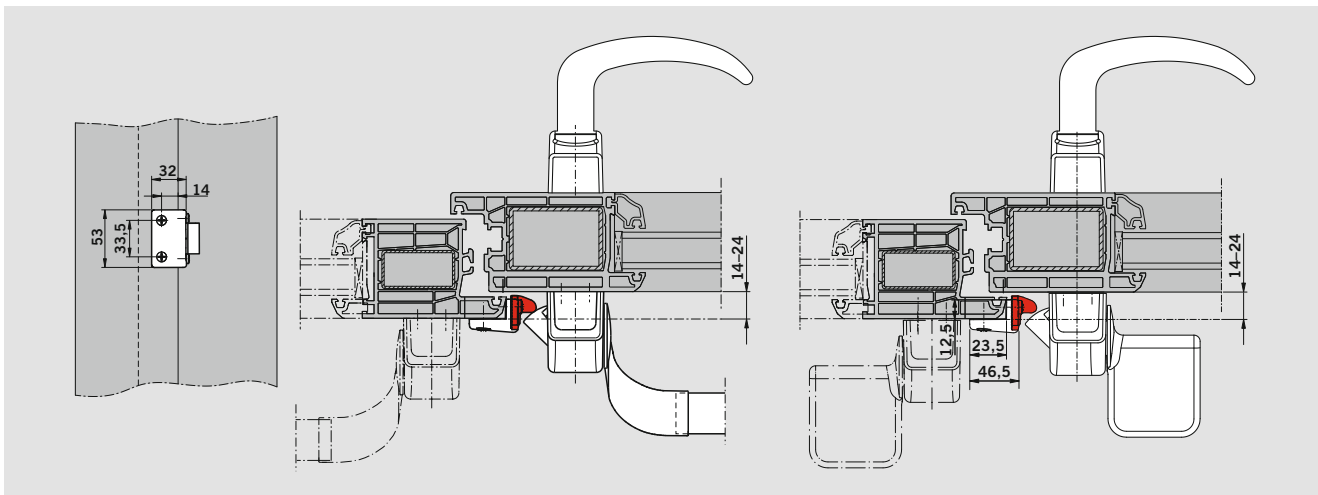

Application example of a PHX 21 on a door with flush meeting stiles, universal applicability for single-leaf and double-leaf doors

**PHX 22 – Adjustable Latch Keeper for PVC Profile Doors**



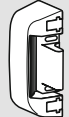

Application example of a PHX 22 on an over-rebated door, universal applicability for single-leaf and double-leaf doors

## ACCESSORIES



	Specification text	Order No.
	<p><b>PHX 50 Electric Strike</b>                      In combination with PHA/PHB for use on standard doors with a rebate overlap of up to 24 mm.                      Zinc die-cast latch engaging device.                      12 V AC, 50 Hz, 15 W</p> <p><input type="checkbox"/> silver finish  <input type="checkbox"/> black  <input type="checkbox"/> white  <input type="checkbox"/> stainless steel finish</p>	<p>35014 24501001                      35014 24501002                      35014 24501010                      35014 24501004</p>
	<p><b>PHX 21 Adjustable Keeper</b>                      For standard aluminium narrow-stile doors, single- and double-leaf, flush or over-rebated (0–11 mm)                      Zinc die-cast latch (in packs of 5)</p> <p><input type="checkbox"/> silver finish  <input type="checkbox"/> black  <input type="checkbox"/> white  <input type="checkbox"/> stainless steel finish</p>	<p>35014 24210101                      35014 24210102                      35014 24210110                      35014 24210104</p>
	<p><b>PHX 22 Adjustable Keeper</b>                      For standard PVC profile doors, single and double leaf, over-rebated (14–24 mm)                      Zinc die-cast latch (in packs of 5)</p> <p><input type="checkbox"/> silver finish  <input type="checkbox"/> black  <input type="checkbox"/> white  <input type="checkbox"/> stainless steel finish</p>	<p>35014 24220101                      35014 24220102                      35014 24220110                      35014 24220104</p>
	<p><b>PHA Microswitch</b>                      For actuation of visual or audible signals.                      Contact rating: max. 48 V DC, max. 3 A</p>	<p>35014 25200060</p>
	<p><b>PHB Microswitch</b>                      For actuation of visual or audible signals.                      Contact rating: max. 48 V DC, max. 3 A</p>	<p>35014 35201061</p>

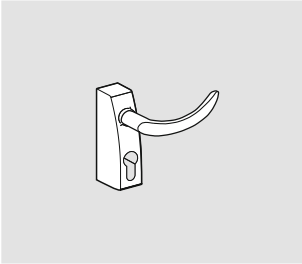
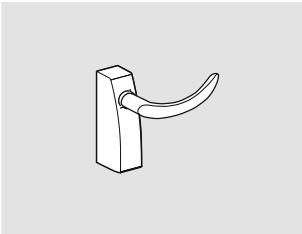
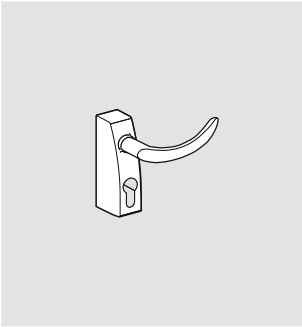
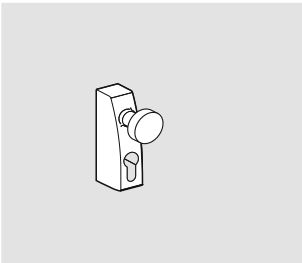
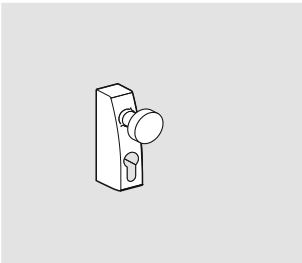

	Specification text	Order No.
	<p><b>PHX Mounting Backplate</b>                      Steel, galvanised (in packs of 10)                      for factory pre-installation to simplify field installation</p>	<p>35014 25200050</p>
	<p><b>PHX Mounting Backplate</b>                      Steel, galvanised (in packs of 10)                      for factory pre-installation to simplify field installation</p>	<p>35014 25200051</p>

# PHT EXTERNAL FITTING

	Specification text	Order No.
	<p><b>PHT</b>                      External fitting with lever handle or knob,                      suitable for use with PHA 2000 and PHB 3000.                      All PHT external fittings are non-handed and carry the CE mark.</p>	
	<p><b>PHT 01</b>                      External fitting with lever handle,                      for standard doors with a leaf thickness of up to 60 mm,                      prepared for installation of a Europrofile single cylinder.                      With lever handle spindle and two cylinder fixing bolts.</p> <p><input type="checkbox"/> silver finish  <input type="checkbox"/> black  <input type="checkbox"/> white</p>	<p>35014 39011001                      35014 39011002                      35014 39011010</p>
	<p><b>PHT 03</b>                      External fitting with lever handle, for standard doors                      with a leaf thickness up to 60 mm, non-lockable.                      With lever handle spindle.</p> <p><input type="checkbox"/> silver finish  <input type="checkbox"/> black  <input type="checkbox"/> white</p>	<p>35014 39031001                      35014 39031002                      35014 39031010</p>
	<p><b>PHT 05 F</b>                      External fitting with lever handle for fire and smoke check                      doors with a leaf thickness up to 60 mm.                      With integrated ring gasket.                      Prepared for installation of a Europrofile single cylinder.                      With lever handle spindle and two cylinder fixing bolts.</p> <p><input type="checkbox"/> silver finish  <input type="checkbox"/> black  <input type="checkbox"/> white  <input type="checkbox"/> stainless steel finish</p>	<p>35014 39051001                      35014 39051002                      35014 39051010                      35014 39051004</p>
	<p><b>PHT 06</b>                      External fitting with knob, non turnable, for standard doors                      with a door thickness up to 60 mm,                      prepared for the installation of a Europrofile single cylinder.                      With lever handle spindle and two cylinder fixing bolts.</p> <p><input type="checkbox"/> silver finish  <input type="checkbox"/> black  <input type="checkbox"/> white</p>	<p>35014 39061001                      35014 39061002                      35014 39061010</p>
	<p><b>PHT 07 F</b>                      External fitting, suitable for combination with lever handles                      or knobs for fire and smoke check doors.                      With lever handle spindle and two cylinder fixing bolts.</p> <p><input type="checkbox"/> silver finish  <input type="checkbox"/> black  <input type="checkbox"/> white  <input type="checkbox"/> stainless steel finish</p>	<p>35014 39071001                      35014 39071002                      35014 39071010                      35014 39071004</p>

	Specification text	Order No.
	<b>PHT S 05 Extended Spindle</b> 8 mm square, incl. fixing screws for door leaf thicknesses of 60 – 105 mm.	35014 39200050
	<b>F Gasket Set</b> For external fitting and PHA / PHB exit devices fixed to fire and smoke check doors.	35014 39200060
	<b>TL-Z 03</b> Single Europrofile cylinder with 3 keys, for PHT 01, 05, 06, 07	35014 56510300

**PHT – External Fitting**

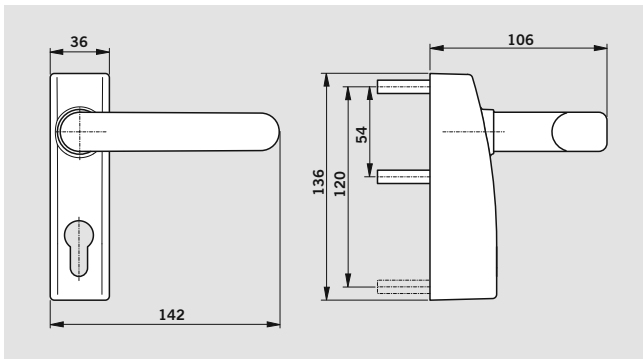

PHT 01, 03, 05 – External fitting with lever handle

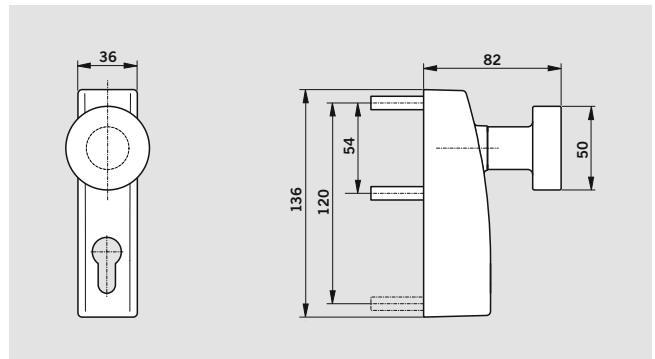

PHT 06 – External fitting with knob

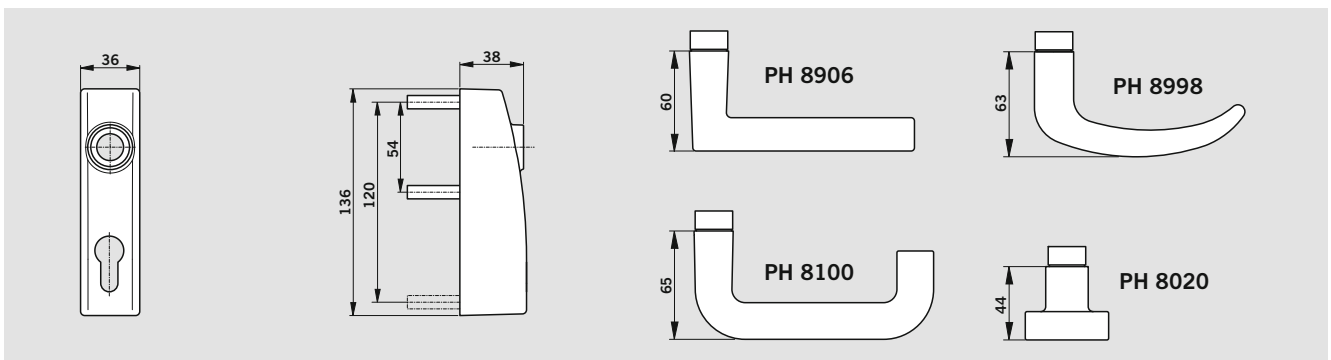

PHT 07 – External fitting, modular

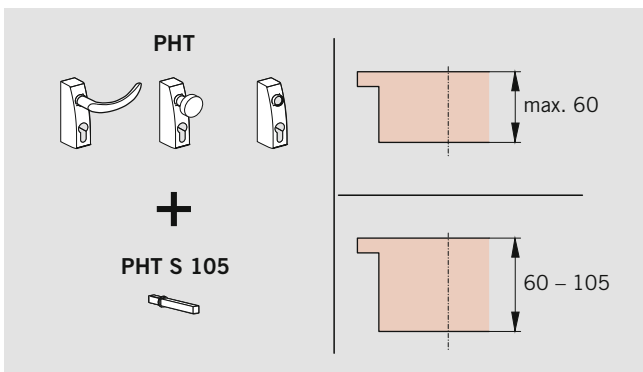

**F**

When using the DORMA PHT external fitting in conjunction with the PHA/PHB panic hardware series or Exit Pad on fire and smoke check doors, it must be ensured that the appropriate set of gaskets is used.

The panic hardware products of the DORMA PHT series carry the CE mark of conformity.



DORMA GmbH+Co. KG  
DORMA Platz 1  
58256 ENNEPITAL  
GERMANY  
Phone +49 2333 793-0  
Fax +49 2333 793-4950  
[www.dorma.com](http://www.dorma.com)